

Logic Panel, Graphic Panel

GP Editor V4.0

USER MANUAL

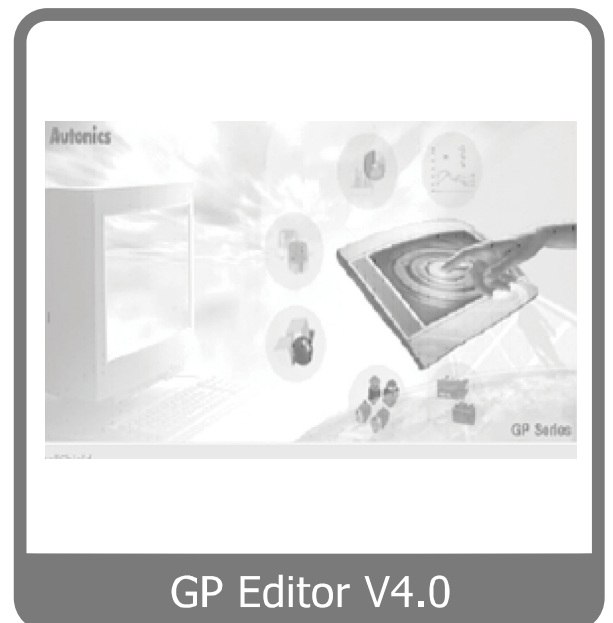

Thank you very much for selecting Autonics products.

For your safety, please read the following before using.

Preface





Thank you very much for selecting Autonics products.

This user manual contains information about the product and its proper use, and should be kept in a place where it will be easy to access.

User Manual Guide

- Please familiarize yourself with the information in this manual before using the product.
- This manual provides detailed information on the product's features. It does not offer any guarantee concerning matters beyond the scope of this manual.
- This manual may not be edited or reproduced in either part or whole without permission.
- A user manual is not provided as part of the product package. Please visit our home-page (www.autonics.com) to download a copy.
- The manual's content may vary depending on changes to the product's software and other unforeseen developments within Autonics, and is subject to change without prior notice. Upgrade notice is provided through our homepage.
- We contrived to describe this manual more easily and correctly. However, if there are any corrections or questions, please notify us these on our homepage.

User Manual Symbols

Symbol	Description
 Note	Supplementary information for a particular feature.
 Warning	Failure to follow instructions can result in serious injury or death.
 Caution	Failure to follow instructions can lead to a minor injury or product damage.
 Ex.	An example of the concerned feature's use.

※ The specifications and dimensions of this manual are subject to change without any notice.

Table of Contents

	Preface	iii
	User Manual Guide	iv
	User Manual Symbols	v
	Table of Contents	vi
1	Product Overview	13
1.1	Features	13
1.2	System requirements	14
1.3	Installation	14
1.4	GP Editor Screen Layout	19
	1.4.1 Menu	20
1.5	Tool	29
1.6	Device	32
2	Project	35
2.1	New Project	35
	2.1.1 GP/PLC type	36
	2.1.2 Project auxiliary property	37
2.2	Load Project	43
2.3	Save Project	44
2.4	Import Project	46
	2.4.1 Select tab	46
	2.4.2 Base tab	47
	2.4.3 Window tab	49
	2.4.4 Part tab	50
	2.4.5 Comment tab	52
2.5	Print	54
	2.5.1 Print procedure	54
	2.5.2 Created file when printing as file	56
2.6	Option	57
	2.6.1 File tab	57
	2.6.2 Browse tab	58
	2.6.3 Communication tab	59
2.7	Exit	61
3	Screen	63
3.1	Screen of GP/LP	63
	3.1.1 Base screen	63
	3.1.2 Window screen	64
3.2	New Screen	67
3.3	Load Screen	68
3.4	Clear Screen	69
3.5	Load and Clear	69

3.6	Save Screen	69
3.7	Save As Screen	70
3.8	Screen Copy/Delete.....	71
3.9	Change Size	72
4	Edit.....	73
4.1	Undo.....	73
4.2	Cut.....	73
4.3	Copy.....	73
4.4	Paste.....	73
4.5	Successive Copy	74
4.6	Delete.....	76
4.7	Select All	76
4.8	Select Object.....	76
4.9	Group	78
4.10	Ungroup	78
4.11	Bring Forward/Send Backward.....	79
4.12	Replace Device.....	81
4.13	Replace Overlap Screen.....	82
4.14	Attribute.....	82
4.15	Alignment.....	83
5	Draw	87
5.1	Panel kit/Part.....	87
5.1.1	Panel kit.....	87
5.1.2	Part.....	91
5.2	Line	92
5.2.1	Basic usage.....	92
5.2.2	Property.....	93
5.3	Rectangle.....	94
5.3.1	Basic usage.....	94
5.3.2	Property.....	95
5.4	Circle.....	96
5.4.1	Basic usage.....	96
5.4.2	Property.....	97
5.5	Text.....	98
5.5.1	Basic usage.....	98
5.5.2	Property.....	99
5.6	Bitmap.....	101
5.6.1	Basic usage.....	102
5.6.2	Property.....	103
5.7	Numeral Input	104
5.7.1	Basic usage.....	104
5.7.2	Property.....	105
5.7.3	Change numeral.....	111

5.8	ASCII Input.....	112
5.8.1	Basic usage.....	112
5.8.2	Property.....	113
5.8.3	Change ASCII.....	118
5.9	Numeral Display	120
5.9.1	Basic usage.....	120
5.9.2	Property.....	121
5.9.3	Display type and operation.....	126
5.10	ASCII Display.....	130
5.10.1	Basic usage.....	130
5.10.2	Property.....	131
5.11	Clock.....	134
5.11.1	Basic usage.....	134
5.11.2	Property.....	134
5.12	Comment Display	137
5.12.1	Basic usage.....	138
5.12.2	Property.....	139
5.13	Alarm History	143
5.13.1	Basic operation.....	143
5.13.2	Basic usage.....	143
5.13.3	Property.....	144
5.14	Alarm List.....	148
5.14.1	Basic usage.....	148
5.14.2	Property.....	149
5.15	Part Display	154
5.15.1	Basic usage.....	156
5.15.2	Property.....	156
5.16	Lamp.....	160
5.16.1	Basic usage.....	160
5.16.2	Property.....	161
5.17	Panel Meter	164
5.17.1	Basic usage.....	164
5.17.2	Property.....	165
5.18	Line Graph.....	170
5.18.1	Basic operation.....	170
5.18.2	Basic usage.....	170
5.18.3	Property.....	171
5.19	Trend Graph.....	176
5.19.1	Basic operation.....	176
5.19.2	Basic usage.....	176
5.19.3	Property.....	177
5.20	Bar Graph	184
5.20.1	Basic operation.....	184
5.20.2	Basic usage.....	184
5.20.3	Property.....	185

5.21	Statistics Graph.....	190
5.21.1	Basic operation.....	190
5.21.2	Basic usage.....	190
5.21.3	Property.....	191
5.22	Touch Key	194
5.22.1	Basic operation.....	194
5.22.2	Basic usage.....	198
5.22.3	Property.....	199
5.23	Overlap Screen.....	209
5.24	Key Window Position	211
6	View.....	213
6.1	Preview	213
6.2	Palette.....	213
6.3	Graphic Library	214
6.4	Tag List.....	215
6.4.1	All tab	215
6.4.2	Numeral display tab.....	216
6.5	Device List	219
6.6	Overlap Screen List	220
6.7	Status bar.....	221
6.8	Toolbar	221
6.9	ON Image.....	221
6.10	Refresh	221
6.11	Option	222
7	Communication.....	223
7.1	Download	224
7.1.1	Download instructions	224
7.1.2	Property.....	224
7.2	Upload.....	228
7.2.1	Execution order	228
7.2.2	Property.....	229
7.3	Memory	233
7.3.1	Execution order	233
7.3.2	Property.....	233
7.4	Check Data	236
7.4.1	Area tab.....	236
7.4.2	Check store memory option tab	237
7.4.3	Level password tab	238
7.4.4	Common device tab	239
7.5	GP Firmware Download.....	240
7.5.1	Firmware download execution order	240
7.6	Option	242
8	Common	243

8.1	Title	243
	8.1.1 Project title	243
	8.1.2 Screen title	244
8.2	GP/PLC Type	245
	8.2.1 PLC connection	245
	8.2.2 Connecting PLC setting	246
	8.2.3 Convert device with changing PLC type	247
8.3	Link Device	249
8.4	System Information	256
	8.4.1 Overview	256
	8.4.2 Read device	256
	8.4.3 Write device	257
	8.4.4 GP inner device	258
8.5	Switch Screen	260
	8.5.1 Basic operation	260
	8.5.2 Property	260
8.6	Security	261
	8.6.1 Basic usage	261
	8.6.2 Property	263
8.7	Comment	266
8.8	Alarm History	269
	8.8.1 Alarm history property	269
8.9	Floating Alarm	276
	8.9.1 Basic operation	276
	8.9.2 Property	277
8.10	Monitor Status	279
	8.10.1 Basic action	279
	8.10.2 Execution order	279
	8.10.3 Property	282
8.11	Recipe	286
	8.11.1 Basic operation	286
	8.11.2 Property	288
8.12	Time Action	292
	8.12.1 Basic operation	292
	8.12.2 Property	292
8.13	Barcode	294
	8.13.1 Basic operation	294
	8.13.2 Barcode read order	295
	8.13.3 Save	296
	8.13.4 Specification of available barcode reader	297
8.14	Auxiliary Configuration	297
	8.14.1 Project	297
	8.14.2 Screen	297
9	Appendix	301
	9.1 USB driver installation	301

9.2	GP Editor runs in Windows 7 operating system	309
9.2.1	GP Editor runs as administrator	309
9.2.2	In case of no administrator account (Create administrator account windows 7)	311
9.2.3	Disable to user account control dialog box	313

1 Product Overview

1.1 Features

All data of GP user screen is edited in private software GP Editor. After editing screen data including forms, arrangement, attribution of tags, download tags to GP/LP, it starts to monitor by the screen data of GP/LP.

- Supports multi-font
It supports windows true type fonts and several bitmap fonts. (It is selectable.)
- Convenient user interface
- Upgrades firmware of GP/LP
- Screen Layout
Title bar, menu, tools, status bar, edit area, non-edit area, preview
- Several edit feature (group, alignment, select, draw)
- Panel kit/Part library
 - Panel kit library: Created library by user
 - Part library: Supplied basic library by GP Editor
 - Part: Registers several numbers or groups of only figure objects (line, rectangle, circle, text, BMP)
- Supplies diverse image library
- Overlap screen for screen edit efficiency and for saving data capacity
- Memory
Feature for composing project screen of GP/LP, memory free space, checking firmware version, and delete the desired screen
- Check data
Automatically executes to check data error when download the data to GP/LP
- Preview
Shows screen on the device with 100% of enlargement ratio
- Supplies help information for program usage

1.2 System requirements

Operating system: Windows 98/NT/XP

Item	Minimum specifications	Recommended specification
CPU	Pentium 4 or above	Pentium Dual Core
Memory	512 MB	1GB
Hard disk	1 GB (Free space)	5GB (Free space)
Resolution	1024 × 768	1280 × 1024

Communication port: RS232 , Serial, USB, Ethernet

1.3 Installation



Note

If GP Editor below V4.0 is installed, delete previous version or designate the other path unlike previous version.

Series		Firmware version
GP-2480		Above V3.00
GP-S Series	GP-S044, GP-S057	Above V3.00
	GP-S070	Above V1.00
LP-S Series	LP-S044	Above V3.00
	LP-S070	Above V1.00

1st For installing GP Editor, visit our homepage (www.autonics.com) and download GP Editor program.

Before installing GP Editor, it is recommended to shut down the other programs.

2nd Double-click installation setup file, and installation is start.

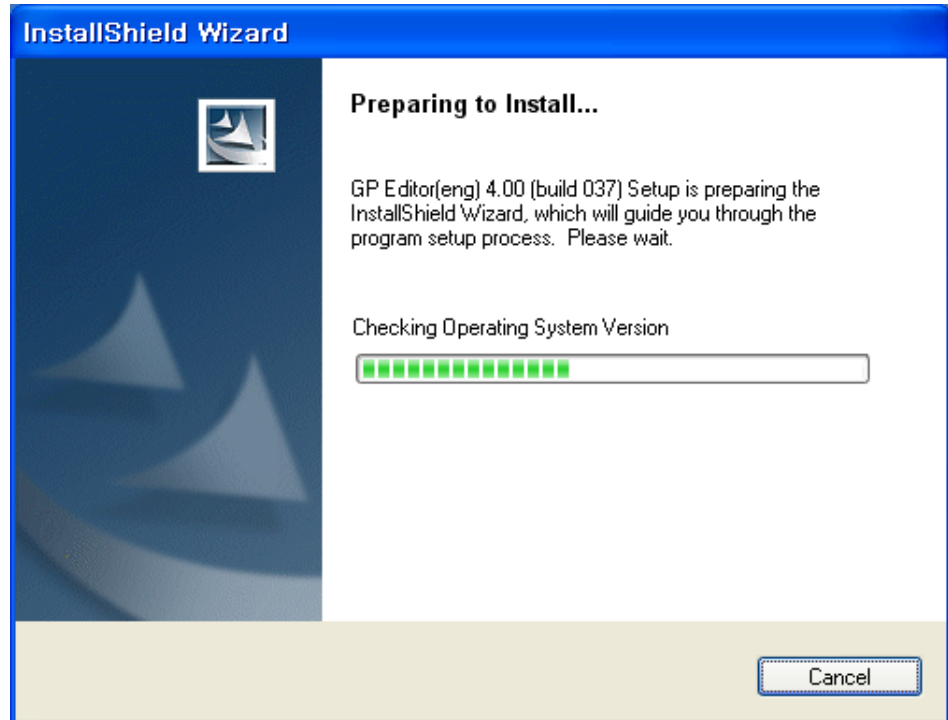

3rd Click 'Next' after installshied wizard is ready.



4th Click 'Next' to continue installation, or 'Cancel' to discontinue installation.

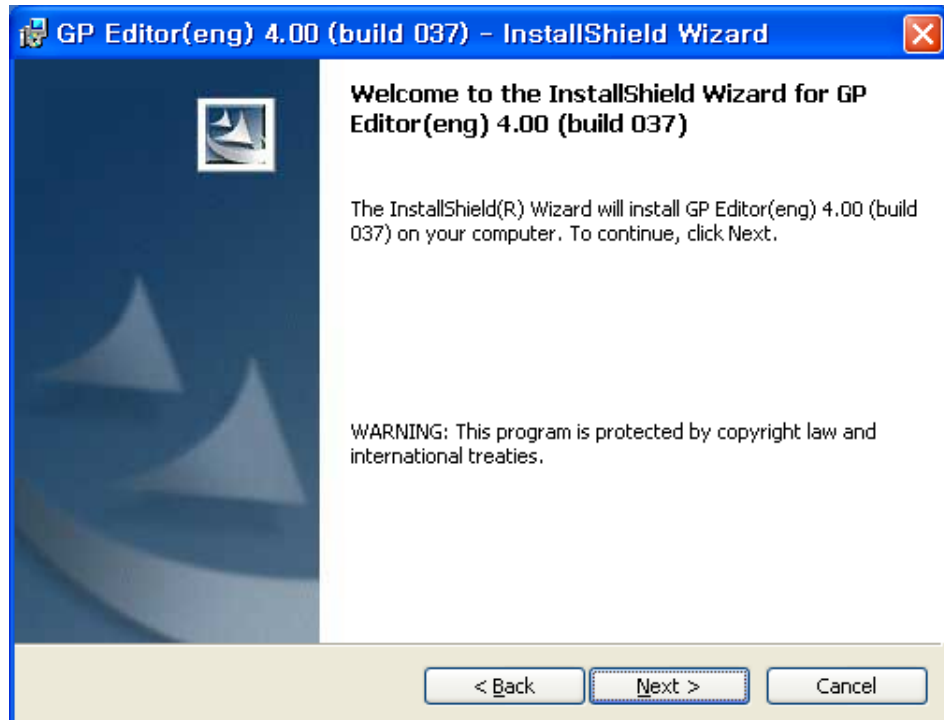

5th Enter your information, and click 'Next'.

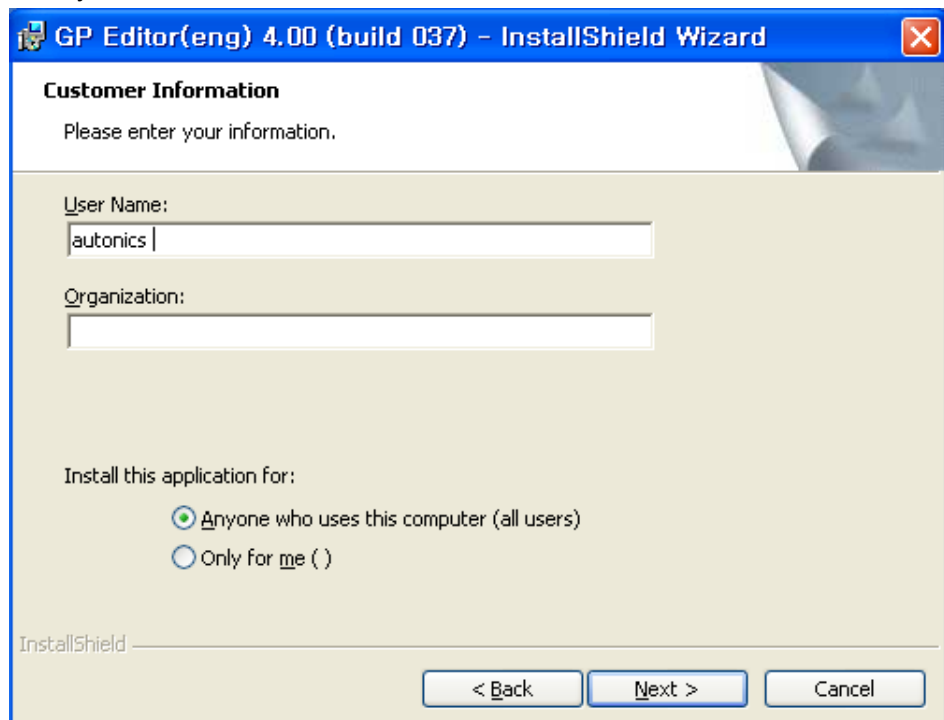

6th Designate installation location, and click 'Next'. (Default installation path is C:/Program Files/Autonics/GP Editor 4.0/.)

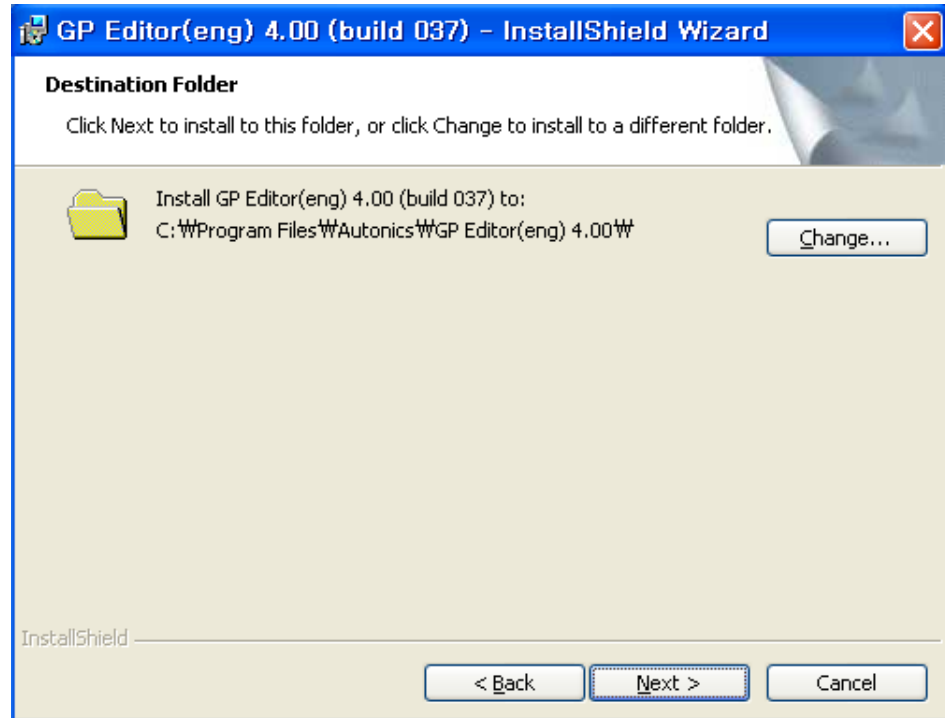

7th To change the installation location, click 'Change' and select the desired folder and click 'OK'.

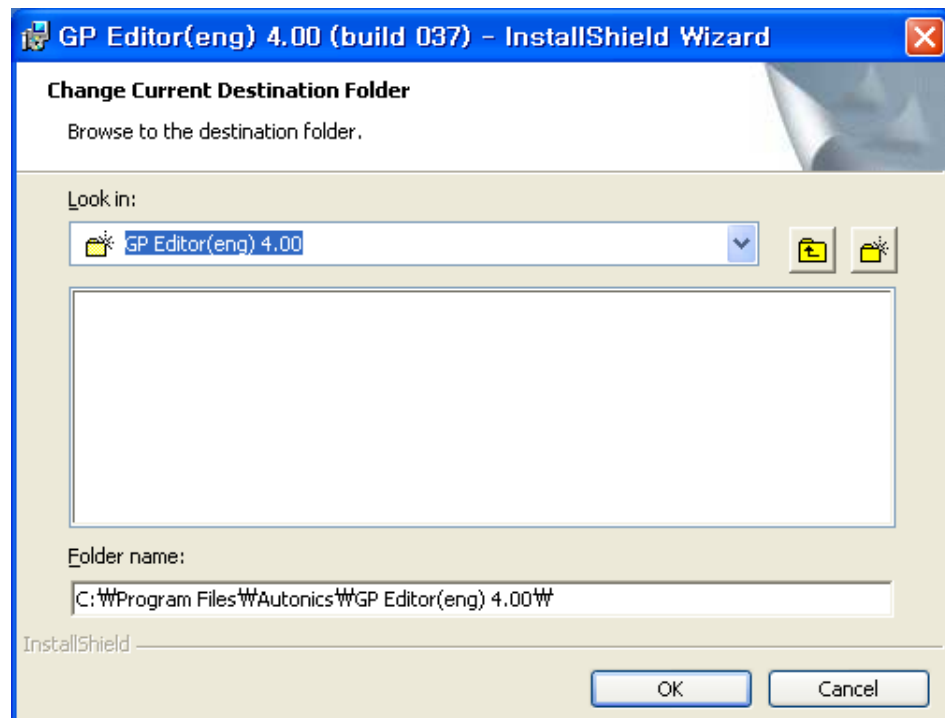

8th Installation starts and you can check installation progress at the same time.

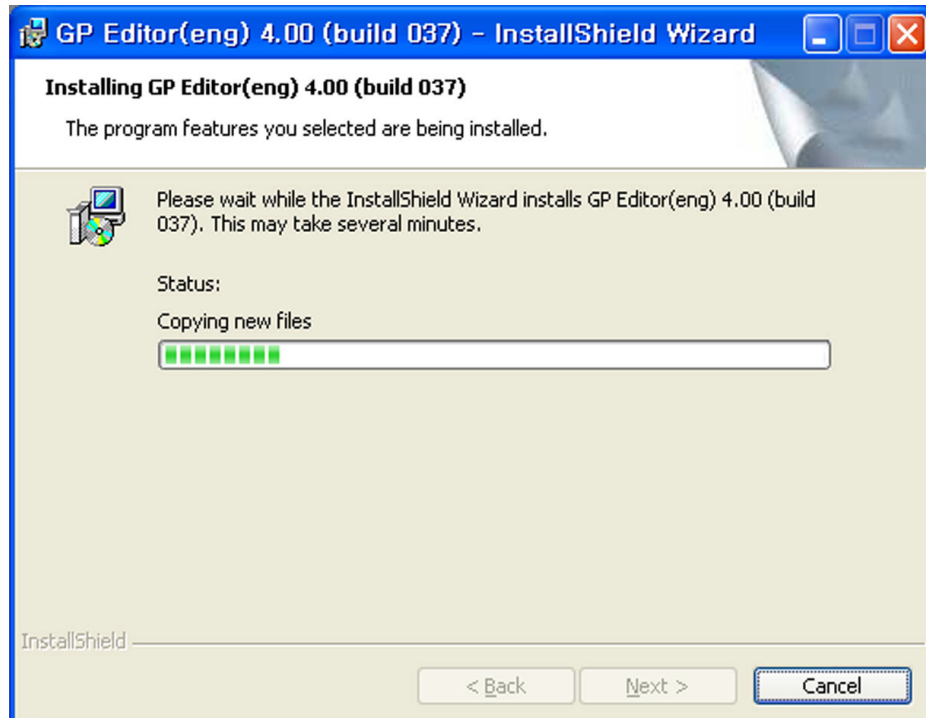

9th After completing installation, click 'Finish' and GP Editor runs. If you do not want to run GP Editor, non-check 'Launch the program' and click 'Finish'.

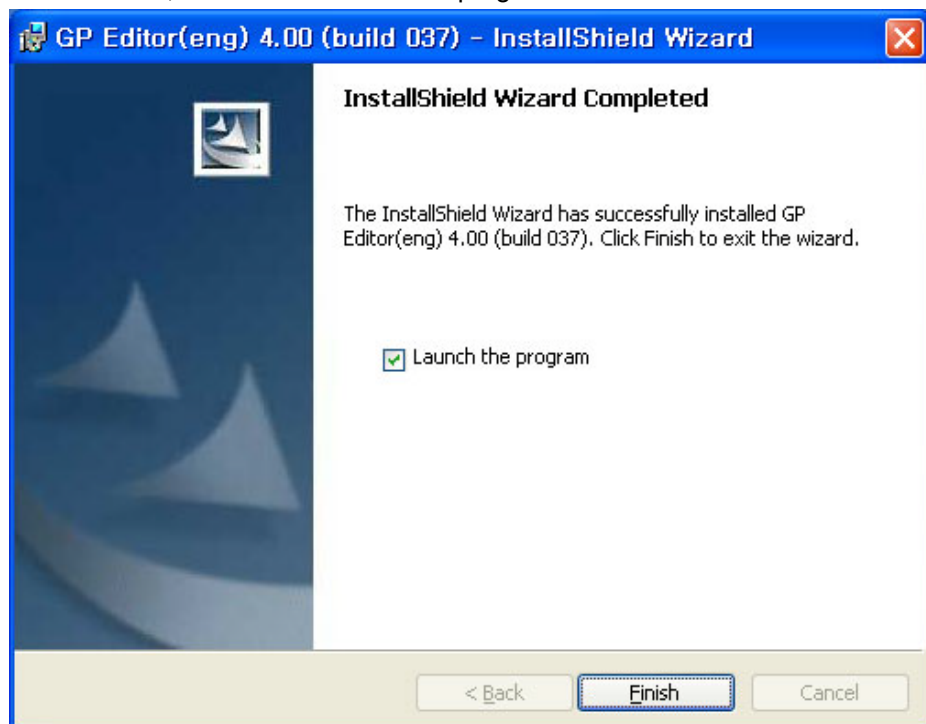



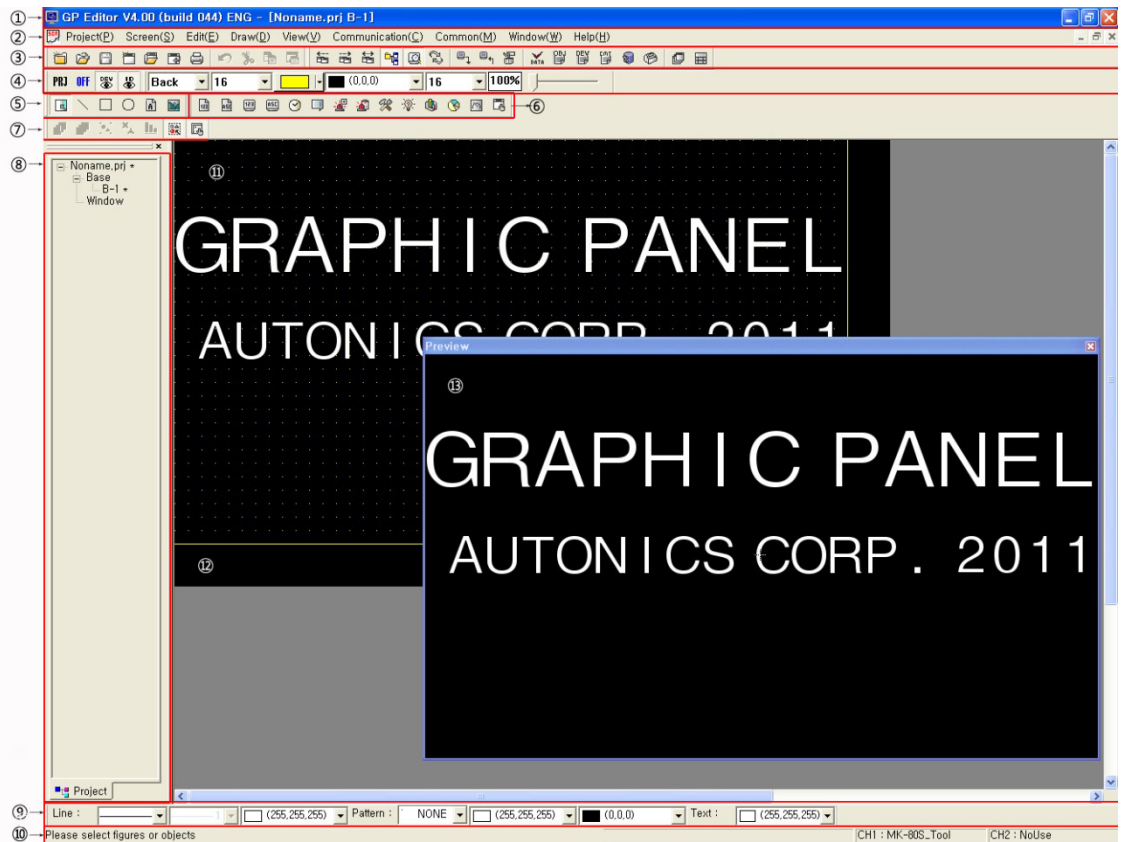





1.4 GP Editor Screen Layout



No.	Name	Description
①	Title bar	Displays number and title of working screen.
②	Menu	Menu for all functions
③	System tool	Tool for project and screen operation
④	View tool	Tool for visual configuration such as tag, background on a edit screen
⑤	Graphic tool	Tool for drawing a graphic figure
⑥	Tag tool	Tool for creating tags
⑦	Edit tool	Tool for selecting an object, stack order and group
⑧	Work space	Displays screen constituting project as a tree
⑨	Drawing tool	Tool for configuration of line, pattern and text of graphic objects
⑩	Status bar	Displays type/size of selected object, mouse position.
⑪	Edit area	Available area designed screen data and downloaded to the device
⑫	Non-edit area	Unavailable area with screen data can be arranged as operation problem
⑬	Preview	Shows GP/LP screen with 100% of enlargement ratio.

1.4.1 Menu





There are project, screen, edit, draw, view, communication, common, window and help menus.

 Project(P)  Screen(S)  Edit(E)  Draw(D)  View(V)  Communication(C)  Common(M)  Window(W)  Help(H)

(1) Project

There are for project menus as following.



Project(P)	
New(N)	Ctrl+N
Load(O)...	Ctrl+O
Clear(C)	
Save(S)	Ctrl+S
Save As(A)...	
Import Project(I)...	
Print(P)...	Ctrl+P
Option(O)	
Exit(X)	

Menu	Description	Hot key	Icon
New	Creates a new project.	Ctrl+N	
Load	Opens saved project	Ctrl+O	
Clear	Closes project		
Save	Saves project	Ctrl+S	
Save As	Saves project as other name		
Import Project	Imports base screen, window screen, part, comment on current project.		
Print	Prints project (project Information, base screen, window screen) with printer or as file.	Ctrl+P	
Option	Configure optional items such as save file, toolbar position, communication configuration.		
Exit	Exits program	Ctrl+X	

(2) Screen

There are for screen menus as following such as new, load, clear and screen copy/delete, etc.











Screen(S)	
New(N)...	Alt+N
Load(L)...	Alt+L
Clear(C)	Alt+W
Load And Clear(Q)...	
Save(S)	Alt+S
Save As(A)...	
Screen Copy/Delete(D)...	
Change Size(H)...	

Menu	Description	Hot key	Icon
New	Creates a new screen	Alt+N	
Load	Loads closed screen of current project	Alt+L	
Clear	Clears screen	Alt+W	
Load And Clear	Clears and loads screen		
Save	Saves screen of current project	Alt+S	
Save As	Saves screen as other name		
Screen Copy/Delete	Copies/deletes successive screens of project at a time.		
Change Size	Adjusts window screen size		

(3) Edit

There are for project edit menu such as undo, cut, copy, etc.

Edit(E)	
Undo(U)	Ctrl+Z
Cut(T)	Ctrl+X
Copy(C)	Ctrl+C
Paste(P)	Ctrl+V
Successive Copy(Y)...	
Delete(D)	DEL
Select All(L)	Ctrl+A
Select Object(S)	▶
Group(G)	Alt+G
Ungroup(U)	Alt+U
Bring Forward(F)	Ctrl+F
Send Backward(B)	Ctrl+B
Replace Device(E)	
Replace Overlap Screen(V)	
Attribute(A)...	ALT+Enter
Alignment(I)...	







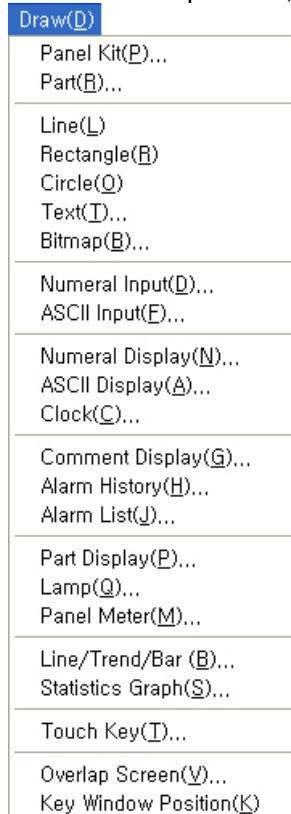



Menu	Description	Hot key	Icon
Undo	Undoes movement, delete, size adjustment etc.	Ctrl+Z	
Cut	Cuts selected object and saves it in clip board	Ctrl+X	
Copy	Copies selected object on screen	Ctrl+C	
Paste	Pastes copied or cut objects on screen	Ctrl+V	
Successive Copy	Copies selected object successively		
Delete	Deletes selected object	Del	
Select All	Selects all objects	Ctrl+A	
Select Object	Figure	Selects figure (Click a mouse or select all)	
	Tag	Selects tag	
Group	Groups selected objects		
Ungroup	Disorganizes group		
Bring Forward	Moves selected object to the forward	Ctrl+F	
Send Backward	Moves selected object to the backward	Ctrl+B	
Replace Device	Changes device used for tag and it is available to select applicable range as all project, current screen, selected object, used device for common configuration.		
Replace Overlap Screen	Changes overlapped screen as other screen		
Attribute	Edits attribution of selected object		
Alignment	Aligns screen arrangement of selected object		

(4) Draw

Draw menu for panel kit, part, line, rectangle, etc is as following.



Menu	Description	Hot key	Icon
Panel Kit	Executes for panel kit: panel kit registration, drawing on screen, save as file, load etc.		
Part	Registers selected object as part, drawing registered part on screen, part library operation etc.		
Line	Draws lines and configures color and style of line		
Rectangle	Draws rectangles, and configures color, style of outline and pattern filled inside of rectangle		
Circle	Draws circles, and configures color, style of outline and pattern filled inside of circle		
Text	Enters text, and configures color and size of text		
Bitmap	Selects bitmap image and inserts it		
Numeral Input	Creates numeric input tags and configures value of designated word device with key window		
ASCII Input	Creates ASCII input tags and configures value of designated word device as ASCII code with key window		
Numeral Display	Creates numeric display tag, displays numeric value saved in PLC device		
ASCII Display	Creates ASCII display tag, displays ASCII value saved in PLC device		
Clock	Creates clock display tag, displays current time or date		

Menu	Description	Hot key	Icon
Comment Display	Creates comment display tag, displays designated comment in accordance with change of designated PLC device value or state		
Alarm History	Creates alarm history tag, and writes alarm history		
Alarm List	Creates alarm list tag, and displays alarm list		
Part Display	Creates part display tag, displays designated part in accordance with change of designated PLC device value or state		
Lamp	Creates lamp tag, displays designated type of lamp in accordance with ON/OFF of designated bit device		
Panel Meter	Creates panel meter tag, and indicates percentage of max/min. value of designated word device with meter needle		
Line/Trend/Bar	Creates line/trend/bar graph tag, displays designated word device value with line/trend/bar graph type		
Statistics Graph	Creates statistic graph tag, displays percentage of designated word device value as graph		
Touch Key	Creates touch key tag, switches screen, operates bit device, sets word device and executes special function by pressing touch key		
Overlap Screen	Draws overlap screen on the current screen		
Key Window Position	Designates the position of key window appeared when inputting numeric and ASCII as upper left		

(5) View

View menu is for preview of screen on GP/LP with 100% ratio, and specifying whether to display toolbar, showing tag/device list.

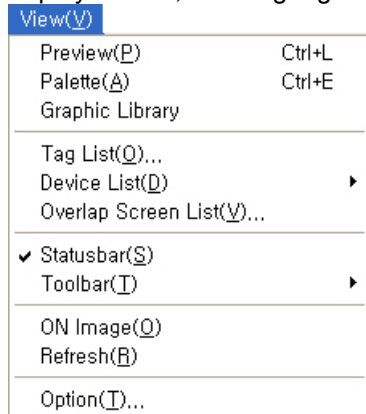



Menu		Description	Hot key	Icon
Preview		Shows screen on the GP/LP with 100% of enlargement ratio		
Palette		Displays tools		
Graphic Library		Select graphic library		
Tag List		Shows tag list of current screen and edits each attribution		
Device List	Screen	Shows device list used for tag of current screen and changes it		
	Project	Shows device list used for project of current screen and changes it		
Overlap Screen List		Shows overlapped screen list on current base screen and changes it		
Status bar		Displays status bar		
Tool bar	System Toolbar	Displays system tool bar		
	View Toolbar	Displays view tool bar		
	Figure Toolbar	Displays figure tool bar		
	Edit Toolbar	Displays edit tool bar		
	Tag Toolbar	Displays tag tool bar		
	Draw Toolbar	Displays draw tool bar		
	Worksp acebar	Displays work space		
ON Image		Shows tag as ON status with checking, or as OFF		
Refresh		Refresh screen		
Option		Configures arrangement of view option and tool assembly		

(6) Communication

For communicate with GP Editor and GP/LP, there are for communication menu such as download, upload, and check data.



Menu	Description	Hot key	Icon
Download	Downloads screen data on GP/LP	Ctrl+D	
Upload	Uploads current screen data of GP/LP	Ctrl+U	
Memory	Checks and deletes screen data of GP/LP		
Check Data	Examines availability of edited data and edits error object		
GP Firmware Download	Downloads the firmware of GP/LP by GP Editor		
Option	Designates communication option such as port or baud rate, etc.		

(7) Common

There are GP/LP system common configuration menus.

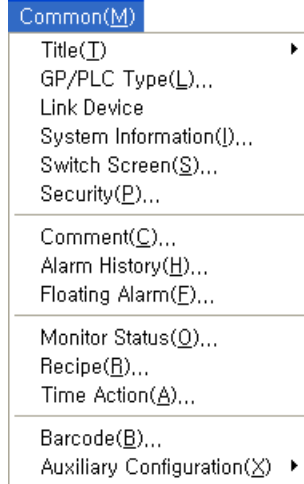

Menu	Description	Hot key	Icon
Title-Project	Edits project title and detail descriptions		
Title-Screen	Edits screen title and detail descriptions		
GP/PLC Type	Confirms and changes of connection PLC		
Link Device	Edits link device configurations		
System Information	Checks read device, write device		
Switch Screen	Designates device for switching screen		
Security	Designates password for security level, usage of security for system screen and communication security		
Comment	Edits comment using commonly in alarm history/alarm list/comment display tags		
Alarm History	Configures monitor device for alarm and observe period		
Floating Alarm	Configures the floating alarm: the specified comment floats from the right to left at bottom of screen when designated observation device is ON		
Monitor Status	Configures bit device state or word device value when specified trigger device has designated status		
Recipe	Configures the recipe: executes read/write operation for several word devices when specified trigger device is ON		
Time Action	Configures the time action: maintains bit device as ON state during certain time		
Barcode	Configures the barcode input		
Auxiliary Configuration-Project	Configures key window operation, edit direction, communication, language, buzzer and position of system access button etc.		
Auxiliary Configuration-Screen	Configures input focus movement of data input tag, key window operation, allowance of floating alarm and security level etc.		

(8) Window

There are for windows alignment of GP Editor.





































Menu	Description	Hot key	Icon
Cascade	Arranges several screens hierarchically		
Tile	Arranges several screens as tiles		
Icon Alignment	Aligns minimized screen icons		

(9) Help









Help menu is for GP Editor's information.



1.5 Tool

Icon	Menu	Description
System tool		
	Project-New	Creates a new project
	Project-Load	Opens saved project
	Project-Save	Saves project
	Screen-New	Creates a new screen
	Screen-Load	Loads closed screen of current project
	Screen-Save	Saves screen of current project
	Project-Print	Prints project
	Edit-Undo	Undoes movement, delete, size adjustment etc.
	Edit-Cut	Cuts selected object and saves it in clip board
	Edit-Copy	Copies selected object on screen
	Edit-Paste	Pastes copied or cut objects on screen
	-	Switches the latest number screen before the current editing screen
	-	Switches the next number screen after the current editing screen
	-	Opens the closed screen when clicking  or 
	View-Toolbar- Workspacebar	Displays work space
	View-Preview	Shows screen on the GP/LP with 100% of enlargement ratio
	View-Refresh	Refresh screen
	Communication-Download	Downloads screen data on GP/LP
	Communication-Upload	Uploads current screen data of GP/LP
	Common-GP/PLC Type	Confirms and changes of connection PLC
	Communication-Check Data	Examines availability of edited data and edits error object
	View-Tag List	Shows tag list of current screen and edits each attribution
	View- Device List	Shows device list used for tag of current screen and changes it
	Common-Comment	Edits comment using commonly in alarm history/alarm list/comment display tags
	Draw-Panel Kit/Part	'Library' of panel kit/part dialog box appears
	View-Palette	Displays tools
	Draw-Overlap Screen	Draws overlap screen on the current screen
	Draw-Key Window Position	Designates the position of key window appeared when inputting numeric and ASCII as upper left
View tool		
	-	Applies view tools to by project or screen
	View-ON Image	Shows tag as ON state, or as OFF
	View-Device List	Shows device list used for tag of current screen
	View-Tag ID	Shows tag ID

Icon	Menu	Description
	-	Designates grid display type
	-	Designates grid interval
	-	Designates grid color
	-	Designates background color
	-	Designates grid snap
	-	Designates an enlargement ratio
Drawing tool		
		Alters mouse cursor for selection
	Draw-Line	Draws lines and configures color and style of line
	Draw-Rectangle	Draws rectangles, and configures color, style of outline and pattern filled inside of rectangle
	Draw-Circle	Draws circles, and configures color, style of outline and pattern filled inside of circle
	Draw-Text	Enters text, and configures color and size of text
	Draw-Bitmap	Selects bitmap image and inserts it
Tag tool		
	Draw-Numerical Input	Creates numeric input tags and configures value of designated word device with key window
	Draw-ASCII Input	Creates ASCII input tags and configures value of designated word device as ASCII code with key window
	Draw-Numerical Display	Creates numeric display tag, displays numeric value saved in PLC device
	Draw-ASCII Display	Creates ASCII display tag, displays ASCII value saved in PLC device
	Draw-Clock	Creates clock display tag, displays current time or date
	Draw-Comment Display	Creates comment display tag, displays designated comment in accordance with change of designated PLC device value or state
	Draw-Alarm History	Creates alarm history tag, and writes alarm history
	Draw-Alarm List	Creates alarm list tag, and displays alarm list
	Draw-Part Display	Creates part display tag, displays designated part in accordance with change of designated PLC device value or state
	Draw-Lamp	Creates lamp tag, displays designated type of lamp in accordance with ON/OFF of designated bit device
	Draw-Line/Trend/Bar	Creates line/trend/bar graph tag, displays designated word device value with line/trend/bar graph type
	Draw-Statistics Graph	Creates statistic graph tag, displays percentage of designated word device value as graph
	Draw-Panel Meter	Creates panel meter tag, and indicates percentage of

Icon	Menu	Description
		max/min. value of designated word device with meter needle
	Draw-Touch Key	Creates touch key tag, switches screen, operates bit device, sets word device and executes special function by pressing touch key
Edit tool		
	Edit-Bring Forward	Moves selected object to the forward
	Edit-Send Backward	Moves selected object to the backward
	Edit-Group	Groups selected objects
	Edit-Ungroup	Disorganizes group
	Edit-Alignment	Aligns screen arrangement of selected object
	Edit-Select Object-Figure	Selects figure (Click it with mouse or select all)
	Edit-Select Object-Tag	Selects tag

1.6 Device

Tag and common configuration is available for monitoring and setting the device value of the connected PLC. For selecting the device, 'Device Select' dialog box has the following construction.

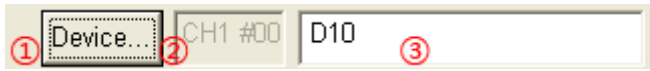

① 'Device Select' dialog box appears.

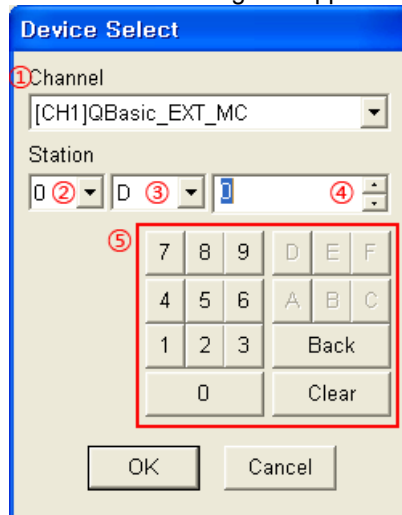

Device Select	Description
① Channel	<p>Select the set device channel by pull-down menu.</p> <p>[CH1]: Select this when using the device for CH1 protocol. [CH2]: Select this when using the device for CH2 protocol. [INTERNAL]: Select this when using GP/LP inner device.</p> <ul style="list-style-type: none"> • Mono type(GP-S044, GP-S057, LP-S044) is able to select only CH1, INTERNAL. For selecting CH2, link device should be set. (Refer to '8.3 Link Device' for more information of link device.) • Color type(GP-S070, LP-S070) is able to select CH1, CH2, and INTERNAL.
② Station	Select the station information of the set device by pull-down menu. (It may not support address depending on the connected device.)
③ Device Name	Displays the selectable device by the device of ①. Select the device to use by pull-down menu. (The selectable device is different depending on PLC, refer to 'GP, LP user manual for communication'.)
④ Address	Designate the device address. (Device address range depends on PLC type. Refer to 'GP, LP user manual for communication'.)

⑤Key	Edits device address with key. By device address form, the related key is activated.
------	--

- ② Indicates the set device channel and address. The indicated address form is 'CH'+Channel number+space +'#' +Address number (3 digit), UB/UW device is not indicated.
Ex) The address of CH1 is 15: CH1 #015
- ③ Indicates the set device.



Note

[Device address mark]

Drawn tag is marked with tag ID, channel, and device.



Item	Description
①Tag ID	Tag ID which is placed at activated drawing screen.
②Channel, device	Displays set channel and device address. Channel is marked as [CH1], [CH2], or [INT]. Ex) <ul style="list-style-type: none"> ▪ In case of [CH1]P0, it displays using CH1 protocol P0 device. ▪ In case of [INT]M0, it displays using GP/LP inner device M0.

2 Project

This chapter describes to create project, to execute program, to configure project attribution and manage project including save, open and import.

2.1 New Project

You can create new project to select [Project]-[New] of menu, to press Ctrl+N, or to click  of tool bar.

When creating new project, you can designate GP/PLC type and basic configuration including edit direction, communication, and language as project auxiliary property.

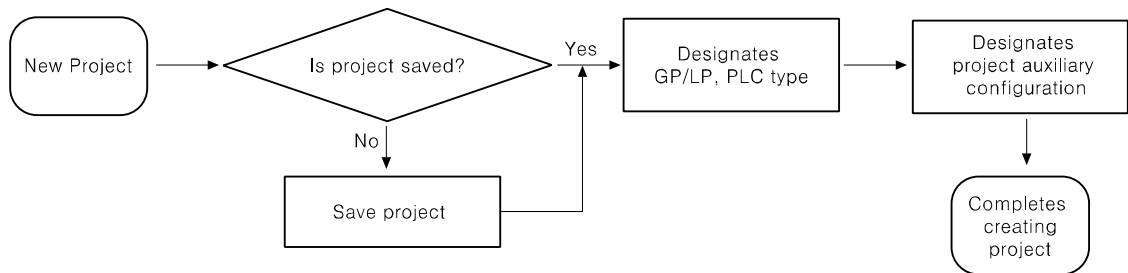

This process is for reducing data writing error providing required items automatically when user create new project. User should keep this comment to protect from design errors when creating project and designate type of connection equipment, then, device of connection equipment can be defined automatically for editing.

2.1.1 GP/PLC type

When creating a new project, you can designate GP/LP and PLC type on 'GP/PLC Type' dialog box. To operate downloaded screen data on GP Editor, user should designate GP and PLC type to be used in the editor correctly.

Select [Common]-[GP/PLC Type] of menu to change the designated GP and PLC type.

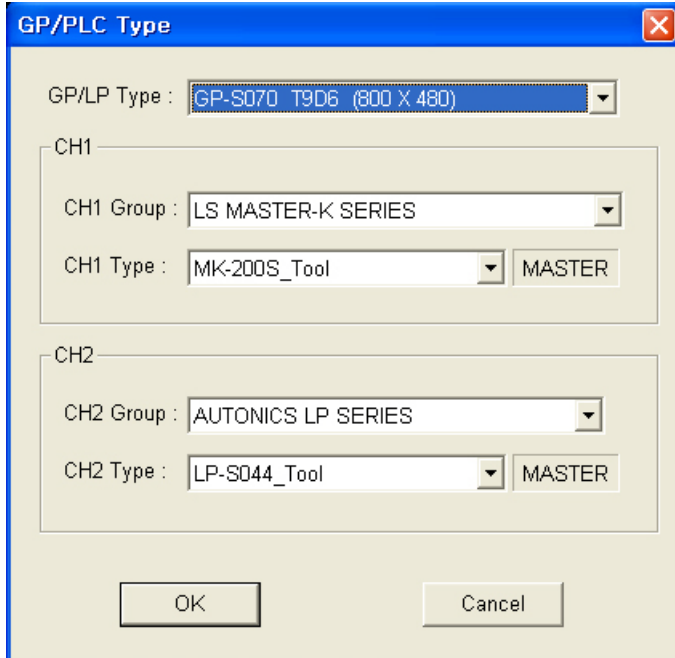

Note

When starting GP Editor, for not to appear 'Project Select' 'GP/PLC Type' dialog box:

Select [Project]-[Option] of menu and non-check 'Select project when program is started'. When starting GP Editor after this, GP and PLC type is designated automatically as the latest saved project's type. 'Project Select' and 'GP/PLC Type' dialog box does not appear.

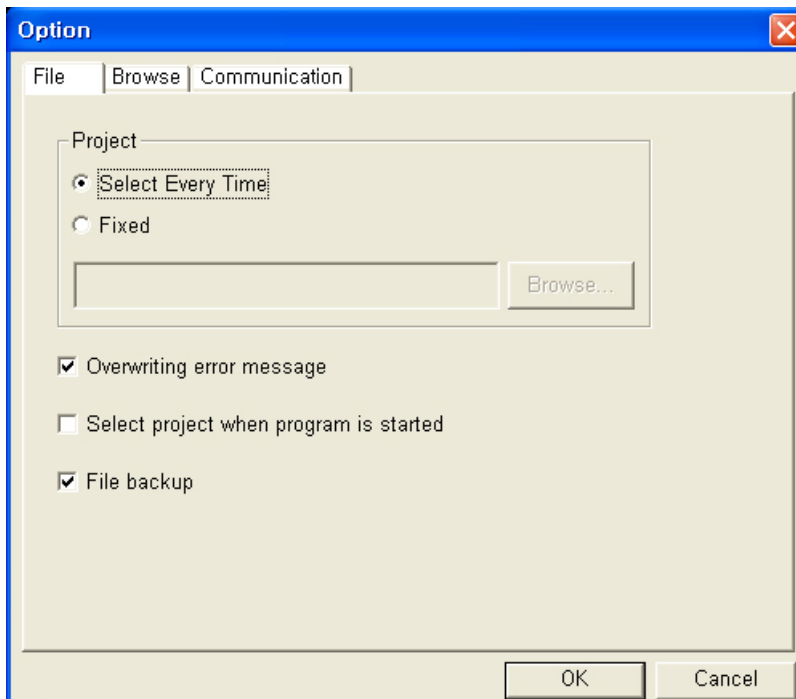

2.1.2 Project auxiliary property

When creating a new project, 'Project Auxiliary Property' dialog box appears automatically after designating 'GP/PLC type' dialog box. Select [Common]-[Auxiliary Configuration]-[Project] of menu to change project auxiliary property.

2.1.2.1 Basic tab

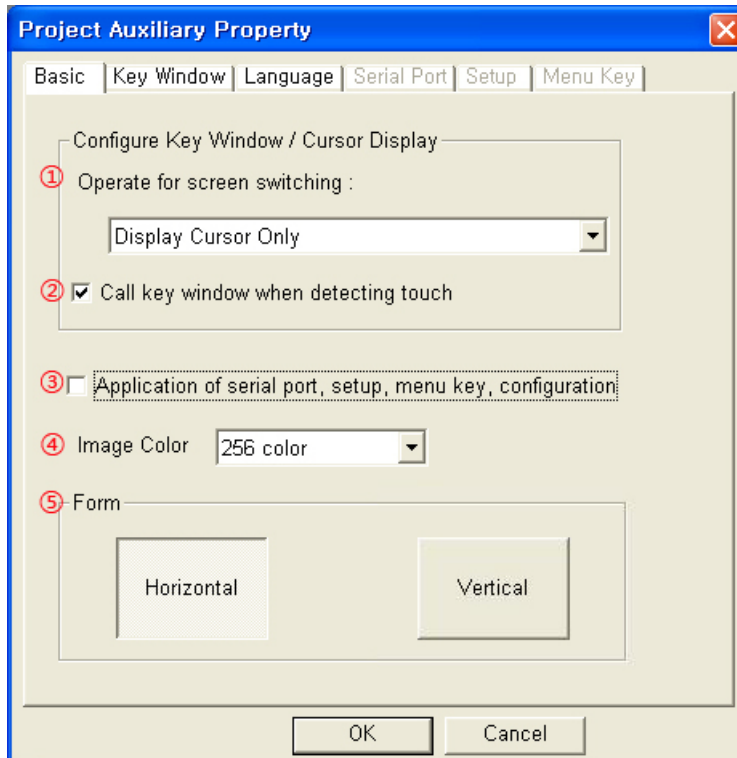

Basic	Description
① Operate for screen switching	Configures key window and cursor display state when changing screen with key input by pull-down menu. <ul style="list-style-type: none"> Do Not Display Cursor And Key Window: Does not display cursor and key window both when changing screen with key input. Display Cursor Only: Displays cursor only when changing screen. Display Cursor And Key Window: Displays cursor and key window both.
② Call key window when detecting touch	Specifies whether to call key window when detecting touch.
③ Application of serial port, setup, menu key, configuration	Check to activate 'Serial Port, Setup, Menu Key' tab.
④ Image Color	Designates the number of image color for project by pull-down menu. <ul style="list-style-type: none"> Mono type (GP-S044, GP-S057, LP-S044): 'Image Color' pull-down menu is non-activated. If the selected image is not mono, it is changed as mono and registered at project. Color type (GP-S070, LP-S070): Select mono, 256 color, 16bit color, or 24bit color.
⑤ Form	<ul style="list-style-type: none"> Horizontal: Edit as horizontal direction Vertical: Edit as vertical direction (Activated only for GP-S044, LP-S044 type)

2.1.2.2 Key window tab

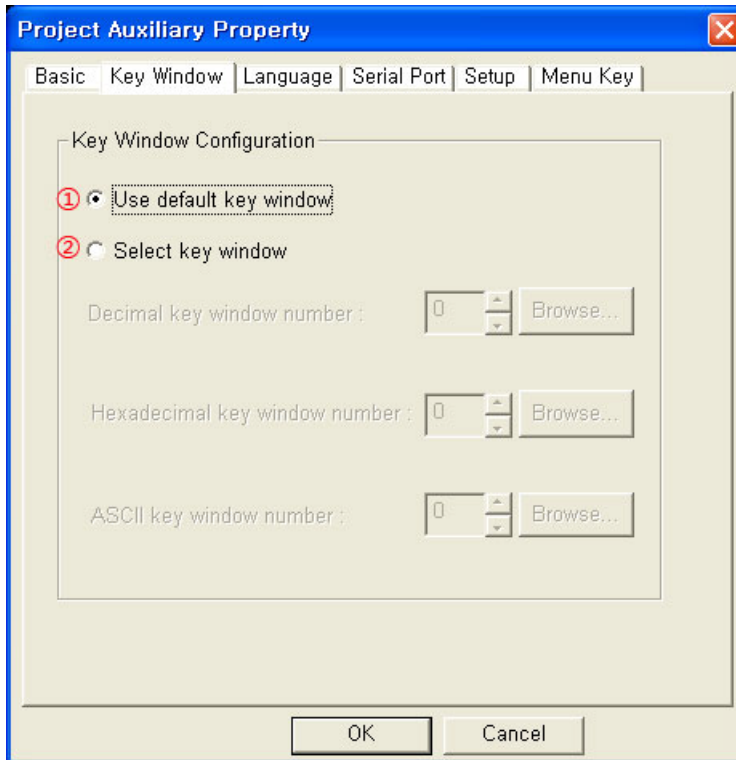

Key Window	Description
① Use default key window	Uses default key window supplied system.
② Select key window	<p>There are three key windows on GP/LP: Decimal key window, Hexadecimal key window, ASCII key window. Uses user-defined key window. (User should designate key window separately.)</p> <p>It is able to select alternating window for each items and has own window screen number with 0 to 500 of configuration range. When it designated as 0, default key window is used for the item.</p> <ul style="list-style-type: none"> Decimal key window number: It is called when it is decimal with sign/without sign in numeral input tag. Hexadecimal key window number: It is called when it is hexadecimal in numeral input tag. ASCII key window number: It is called in ASCII input tag.

2.1.2.3 Language tab

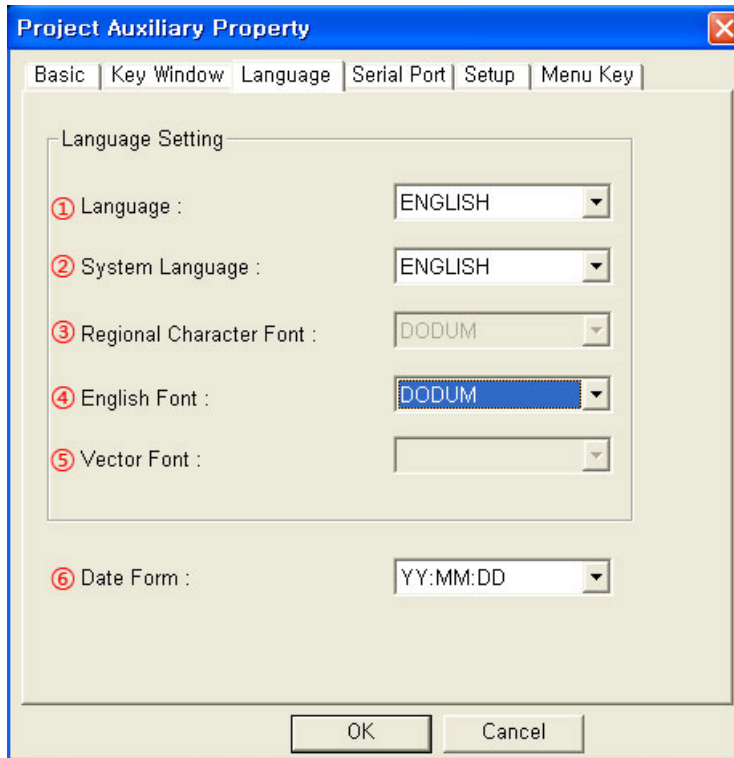

Language	Description		
① Language	Configures using language by pull-down menu.		
② System language	Configures language using in system screen of GP/LP by pull-down menu.		
③ Regional Character Font	Configures bitmap font of regional character by pull-down menu.		
④ English Font	Configures bitmap font of ASCII character by pull-down menu.		
⑤ Vector Font	Configures vector font by pull-down menu. (Activates only for color type(GP-S070, LP-S070))		
⑥ Date Form	Designates the data form from 6 types of date display form for display of system screen by pull-down menu.		
	YY(Year):MM(Month): DD(Day)	YY:DD:MM	DD:YY:MM
	DD:MM:YY	MM:DD:YY	MM:YY:DD



Note

- Configuration of language: The character display in editing on GP Editor and in displays on GP/LP is displayed according to character code for the designated language. For editing of text, configure same with language configuration of current operating system. For example, configure language as Korean in PC using English OS, it is written as English. It refers to Korean character code and it may displays incorrectly for input text
- Configuration of font: If configured font in language tab is different in GP/LP's one, it is downloaded together when downloading GP Editor's data. There are ASCII character font and regional character font.

2.1.2.4 Serial port tab

It is configuration of serial connection when connecting main device with editor, barcode reader and print. It is configuration of CH1 communication port, in [SYSTEM SETTING]-[Connect PLC] of mono type GP/LP or in [SYSTEM SETTING]-[Environment]- [Serial Communication] of color type GP/LP.

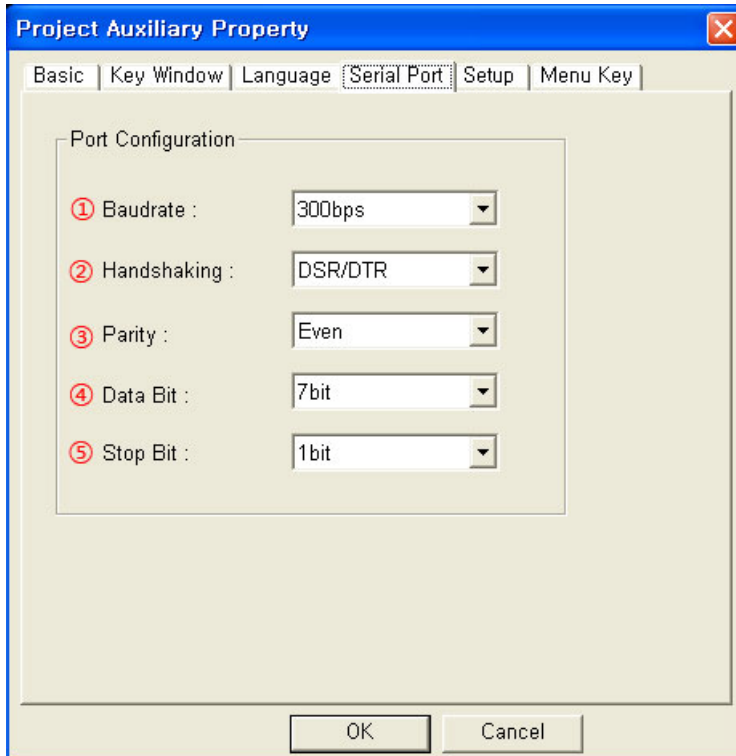

Serial Port	Setting value
① Baudrate	300, 600, 900, 1200, 2400, 4800, 9600, 19200, 38400, 57600, 115200bps
② Handshaking	XON/XOFF, DSR/DTR
③ Parity	None, Even, Odd
④ Data Bit	7, 8 bit
⑤ Stop Bit	1, 2 bit

2.1.2.5 Setup tab

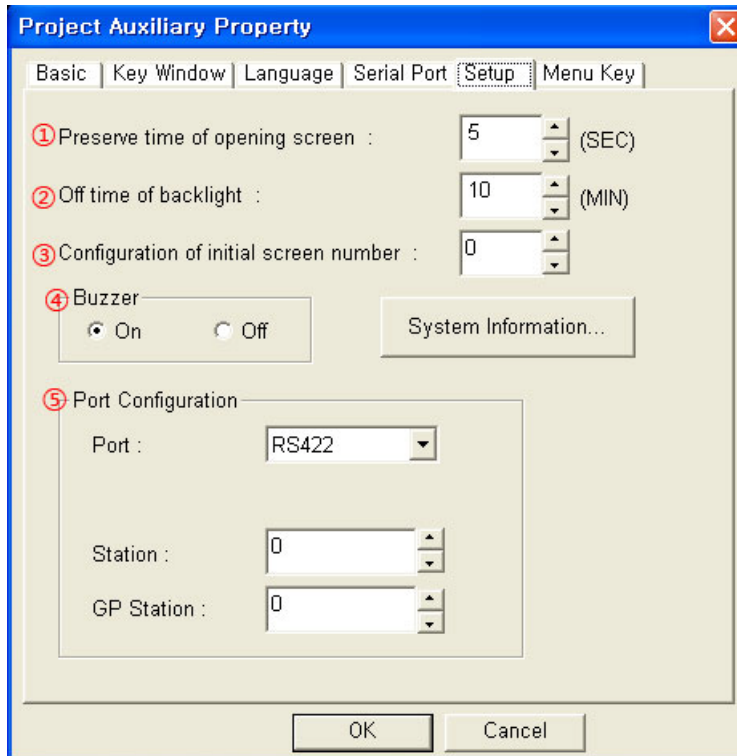

Setup	Description
① Preserve time of opening screen	When supplying power on GP/LP, it shows basic information (releasing year, firmware version) as opening screen. It is able to set preserve time of this screen with range of 0 to 60 sec.
② Off time of backlight	If there is no touch on screen of GP/LP until off time of backlight, LCD backlight is OFF. Backlight is ON again when user touches it. It is able to set as minute unit with range of 0 to 99 min and backlight will not be OFF when it is configured as 0 min.
③ Configuration of initial screen number	It designates to use designed user screen as opening screen. It is able to set 0 to 500 of screen number. If it is designated as 0 or there is no designated user screen number, it shows basic information (Releasing year, firmware version) of product for ① preserve time of opening screen.
④ Buzzer	It configures to buzzer or not to buzzer when pressing touch key or other situation.
⑤ Port Configuration	<ul style="list-style-type: none"> Port: Specifies PLC and connecting port type by pull-down menu. Station: Designates station of PLC from 0 to 255. GP Station: Designates station of GP from 0 to 255.

2.1.2.6 Menu key tab

Designates key position to enter system screen of GP/LP.

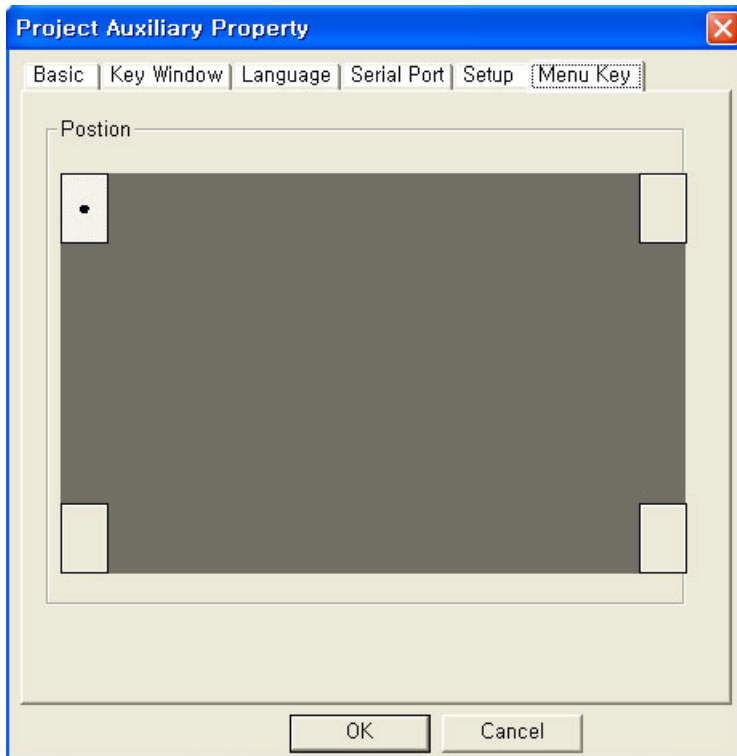

It is able to designate one point or two points among four corners of GP/LP screen. When designating two points, press two corners simultaneously to enter system menu.



Note

After supplying power, it is able to enter system menu with touching corner of upper-left (Based on the horizontal).

2.2 Load Project

1st Select [Project]-[Load] of menu, press Ctrl+O, or click  of tool bar.

If the current project is not saved, the following message appears to save the project.

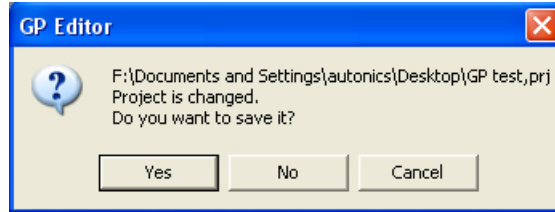

2nd 'GP EDITOR Project Open' dialog box appears.

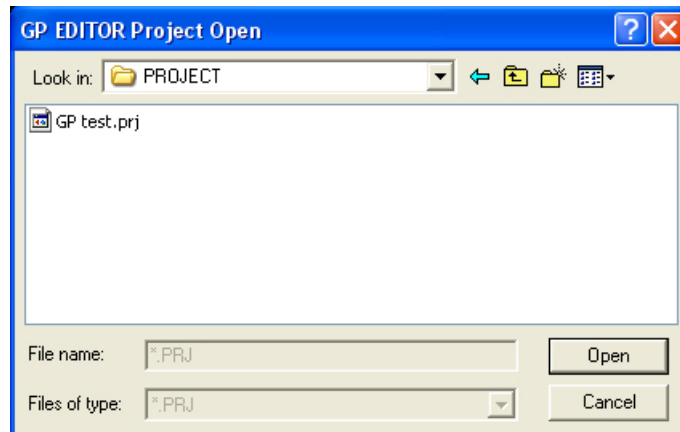

3rd Designate the path to load project. Click 'open' and the selected project is open.

2.3 Save Project

You can save the edited project as a file to select [Project]-[Save] of menu, to press Ctrl+S, or to click  of tool bar.

If you want to save the project to another file name, select [Project]-[Save As] of menu.

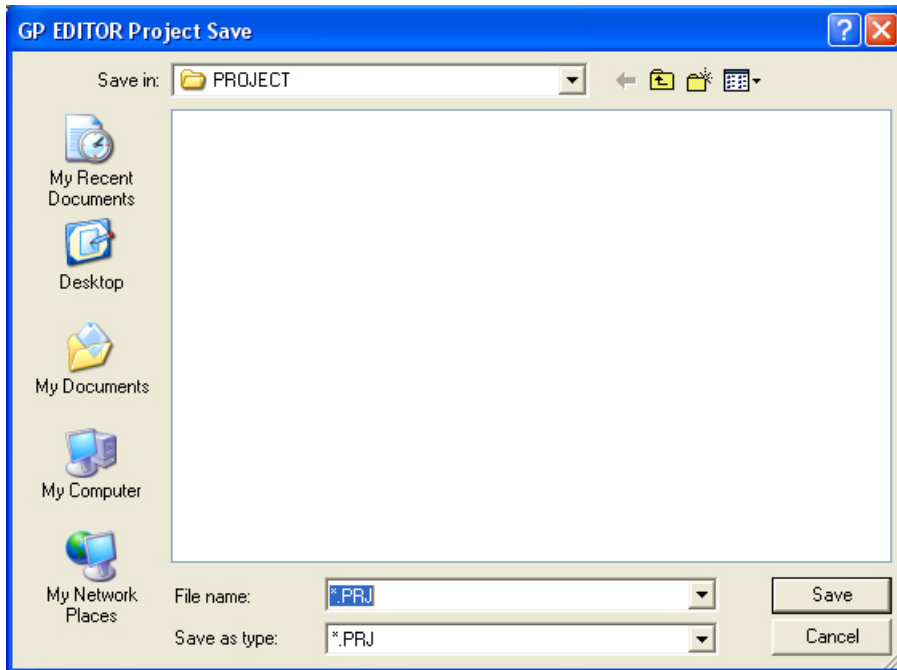

- [Project]-[Save]
If the project is not saved before, 'GP EDITOR Project Save' dialog box appears to designate file path and save it. If the project is saved before, this dialog box does not appear and is saved to overwrite on the saved project.
- [Project]-[Save As]
'GP EDITOR Project Save' dialog box appears to designate file path and save as another file name.



Note

- To save the latest state project when saving project:
Select [Project]-[Option] of menu and 'Option' dialog box appears. From 'File' tab, check 'File backup'.
 - Mono type
It saves project file as 'Backup.prj' in the folder which has the project file. It creates 'Backup' folder and saves backup the included files of the project in this 'Backup' folder.
 - Color type
'*_backup.prj' file is created and is saved backup in the folder which has the project file.
- *_backup.prj' file is created separately under the working folder and it is saved.

- To verify whether to save the project all the time:
Select [Project]-[Option] of menu and 'Option' dialog box appears. From 'File' tab, check 'Overwriting error message'.
Whenever you save the project, 'Project overwrites check' dialog box appears and verify whether to save the project.

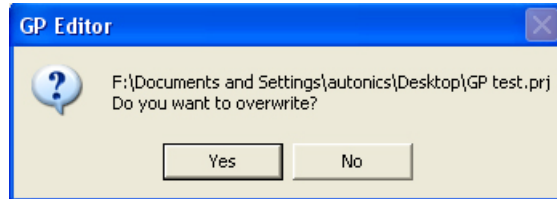

Note

Project file structure of GP/LP type

- Mono type**
Project file of mono type (GP-S044, GP-S057, LP-S044) is composed of several files as one project.

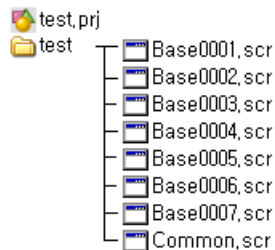

The above figure is an example of creating 'test' project.

When saving 'test' project, 'test.prj' project file which is represented whole project and 'test' directory are created. 'test' directory has several files for screen information, etc of this project.

For copying project, both 'test.prj' and 'test' directory should be copied together.

- Color type**
Project file of color type(GP-S070, LP-S070) is composed of one file as one project.

2.4 Import Project

It registers to editing project importing partial or whole of base, window screen, comment and part of other project.



Note

Limitation of import project function by GP/LP type: Import project is only able to between same GP/LP color type of the project. Mono type of project is able to import only mono type project and Color type of project is able to import only color type project.

2.4.1 Select tab

1st Select [Project]-[Import Project] of menu, and 'Import Project' dialog box appears.

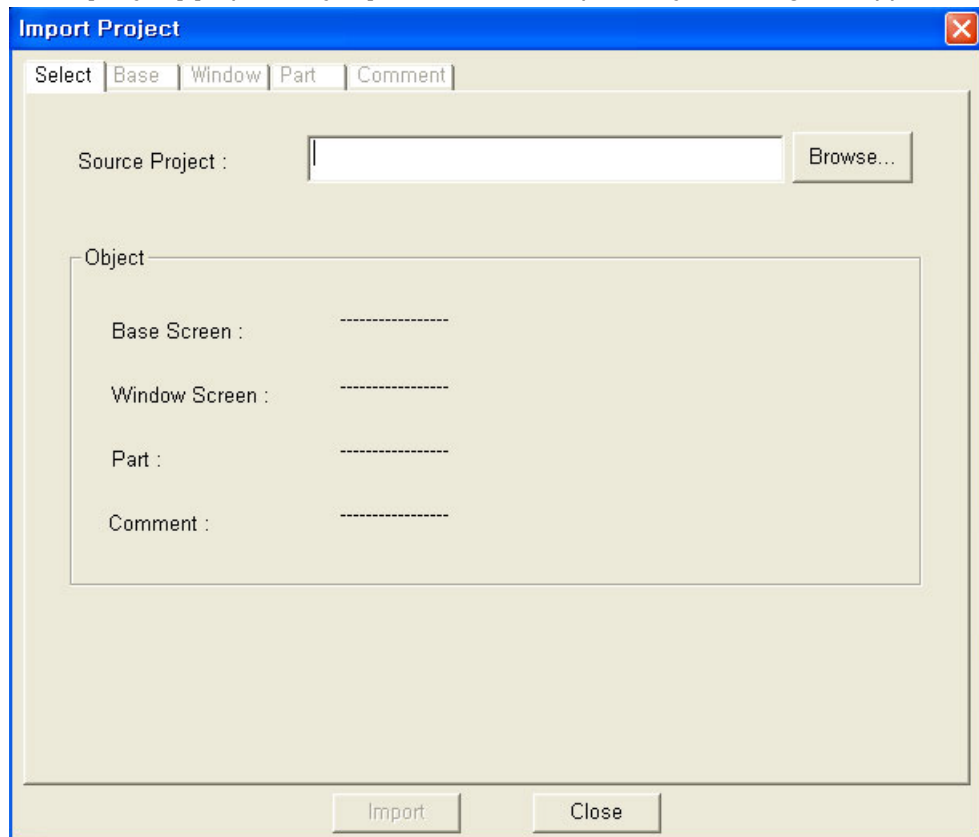

2nd Click 'Browse', and 'GP EDITOR PROJECT OPEN' dialog box appears.

3rd Select the imported project.

2.4.2 Base tab

1st If the imported project is not selected from 'Select' tab, click 'Browse' and select the project.

2nd Move to 'Base' tab.

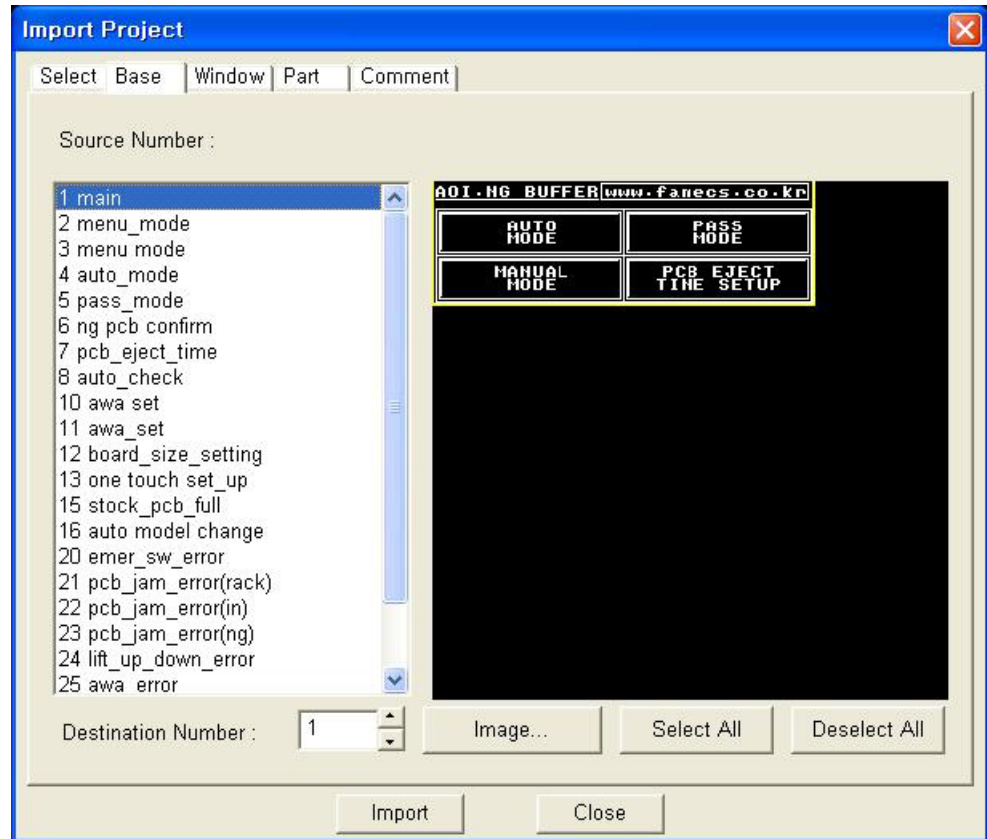

Base screen list of the imported project is specified on 'Source Number' list box.

Select one base from 'Source Number' list box, the base image is displayed on the left.

3rd From 'Source Number' list box, select the base image by clicking, dragging, clicking 'Select All' or clicking 'Deselect All'.

[Selecting the screen from 'Source Number' list box]

- ◆ Click 'Select All' to select all base screens of 'Source Number' list box.
- ◆ Drag mouse to select several base screens within dragged area.
- ◆ Click several base screens with press Ctrl key.
- ◆ Select consecutive base screens with press arrow keys for direction and Shift key.

4th Designate the desired screen number of current project to be entered the imported base screen on 'Destination Number'. Click 'Image' and 'Screen Image' dialog box appears and it shows the current project screens. Designate the screen number on 'Number'.

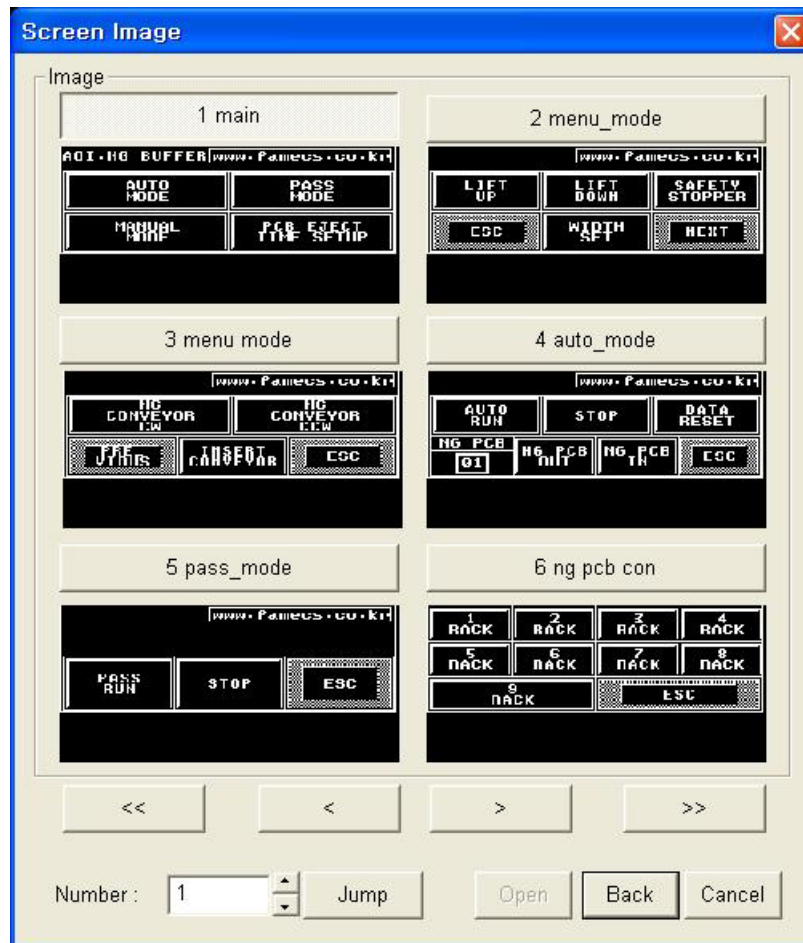

[Operating 'Screen Image' dialog box]

- Click '<<', '<', '>', '>>' and screen image is changed as one page or previous/next number of screen as one.
- Enter 'Number' for the desired screen. Click 'Jump', and screen images of next number are displayed with the number of screen at the head.
- Click the screen image or enter 'Number' for the desired screen.
- Click 'Back', and 'Number' for the desired screen is entered on 'Destination Number' of 'Base' tab.

- 5th Click 'Import', and selected base screens in 'Source Number' list box are copied in order from destination number of current project.
- If the screen of destination number has already written, 'Confirm Screen Overwrite' dialog box appears.

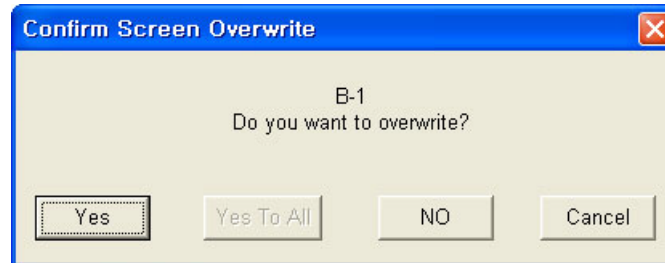

2.4.3 Window tab

It is operated same with base screen.

2.4.4 Part tab

- 1st If the imported project is not selected from 'Select' tab, click 'Browse' and select the project.
- 2nd Move to 'Part' tab.

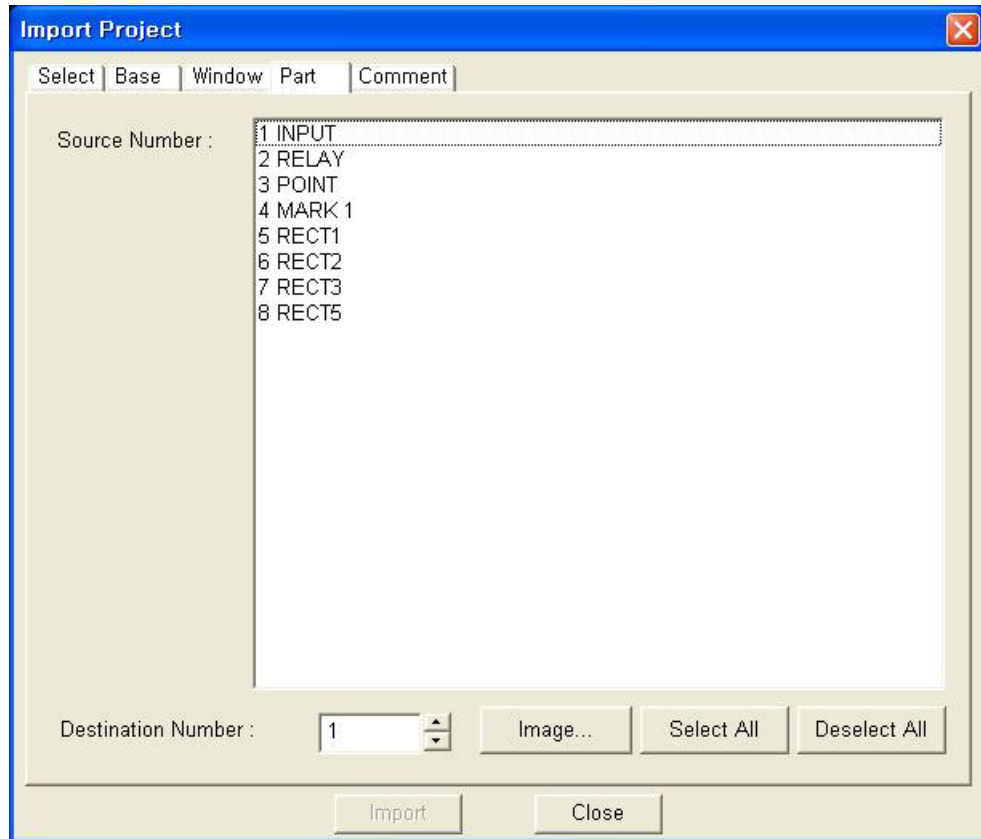

- 3rd From 'Source Number' list box, select the desired part. Selecting and operating the screen from 'Source Number' list box are same as 'Base' tab.
- 4th Designate the desired part number of current project to be entered the imported part on 'Destination Number'. Click 'Image' and 'Image Selection' dialog box appears and it shows the current project parts.

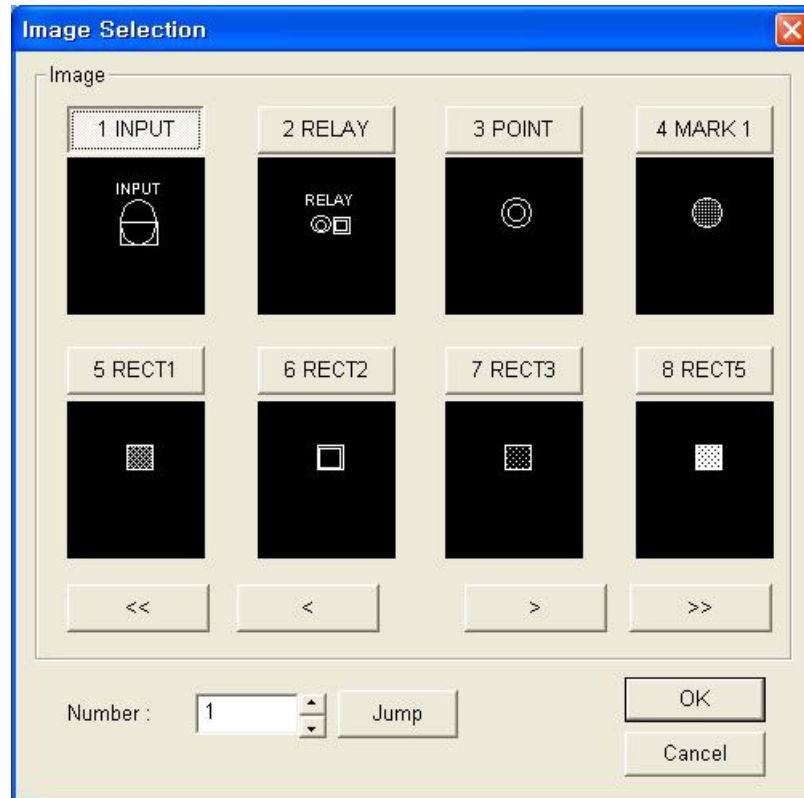

[Operating 'Image Selection' dialog box]

- ◆ Click '<<, <, >, >>', part image is changed as one page or previous/next number of screen as one.
- ◆ Enter 'Number' for the desired part image. Click 'Jump', and the part images of next number are displayed with the number of part image at the head.
- ◆ Click the image or enter 'Number' for the desired image.
- ◆ Click 'OK', and 'Number' for the desired image is entered on 'Destination Number' of 'Part' tab.

5th Click 'Import', and selected images in 'Source Number' list box are copied in order from destination number of current project.

If the destination number has already parts, 'Confirm Parts Overwrite' dialog box appears.

2.4.5 Comment tab

1st If the imported project is not selected from 'Select' tab, click 'Browse' and select the project.

2nd Move to 'Comment' tab.

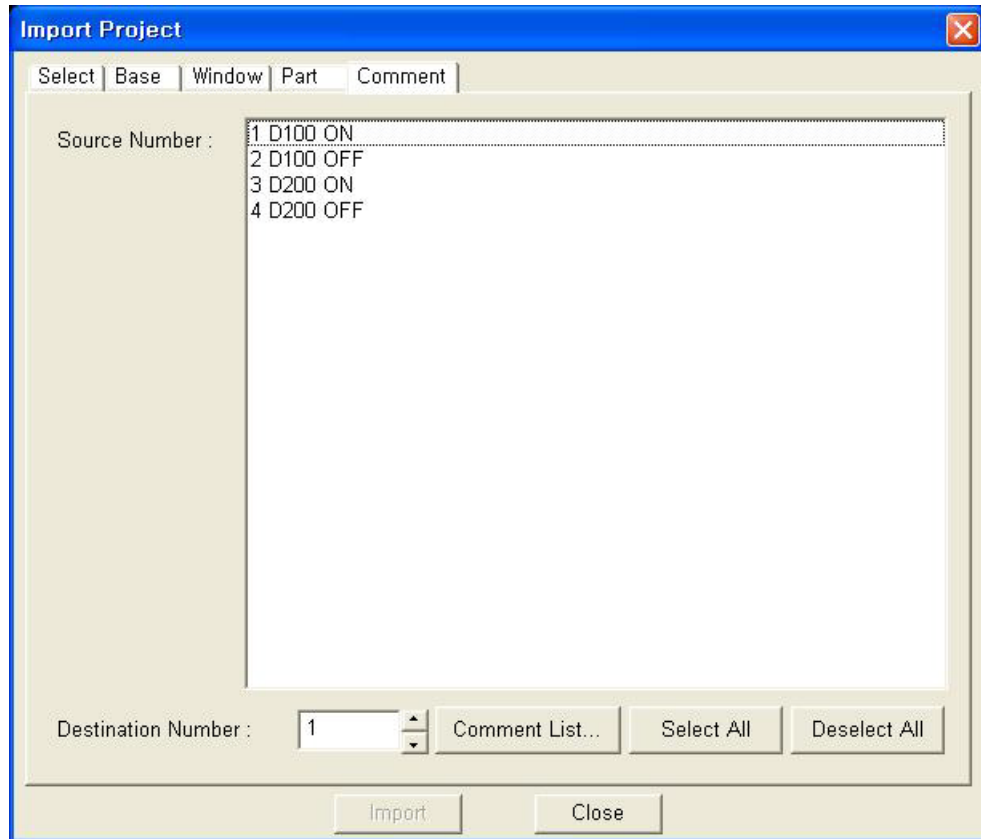

3rd From 'Source Number' list box, select the comment.

Designate the desired comment number of current project to be entered the imported comment on 'Destination Number'. Click 'Comment List' and 'Comment List' dialog box appears and it shows the current project comments.

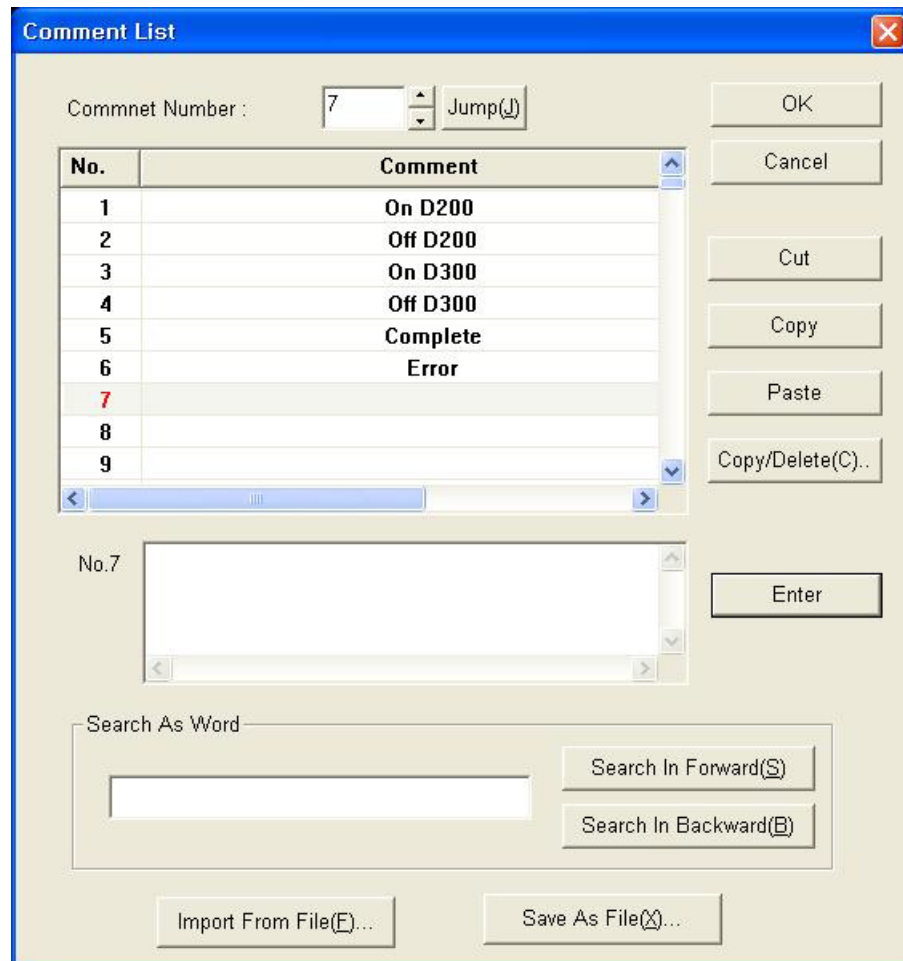

4th Click 'Import', and selected comments in 'Source Number' list box are copied in order from destination number of current project.

If the destination number has already comments, 'Confirm Comment Overwrite' dialog box appears.

2.5 Print

It prints image, tag, configuration of tag and device list of screen as print or file.

2.5.1 Print procedure

1st Select [Project]-[Print] of menu, 'Print Attribute' dialog box appears.

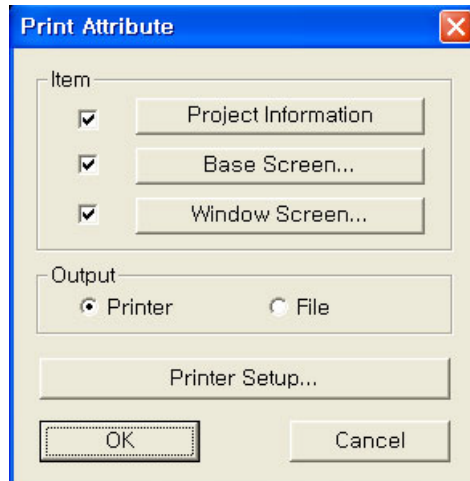

2nd To print with printer, select 'Printer' of 'Output' box. To print with file, select 'File' of 'Output' box. 'Output' box is activated when project is saved and able to print as file.

3rd To print common configuration and device list of project, check 'Project Information' and click this. 'Project Information' dialog box appears. Check the desired items to print 'Common Configuration' and 'Device List'.

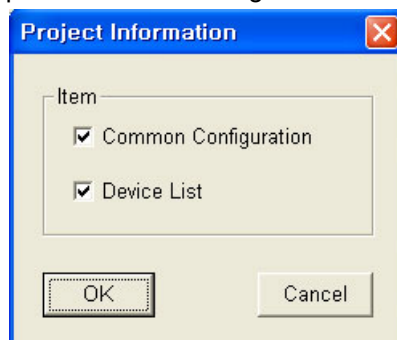

4th To print base screen, check 'Base Screen' and click this. 'Base Screen' dialog box appears.

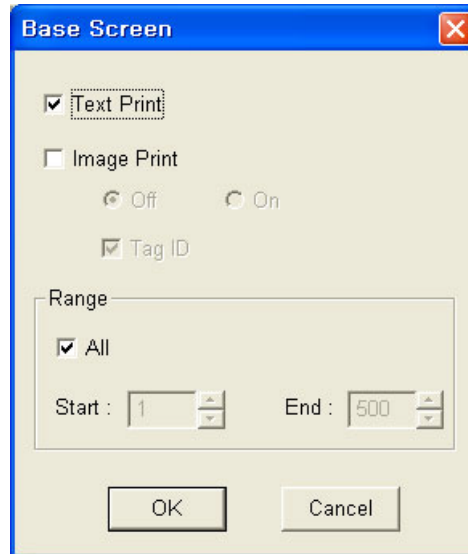

- Text Print: Prints the number of base screen, title, and used tag as text.
- Image Print: Prints images of base screen. It is saved as bitmap file when it is print as file.
- Off/On: Designate ON or OFF image to print. Select one between Off or On.
- Tag ID: Prints tag images with each tag ID.
- Range: Check 'All' to print all screens of the project. Non-check 'All', and designate the screen start number and end number to print part.

5th To print window screen, check 'Window Screen' and click this. 'Window Screen' dialog box appears.

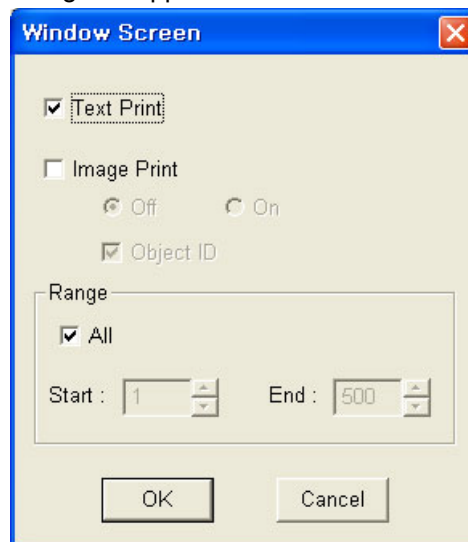

The operation of 'Window Screen' dialog box is same as the that of 'Base Screen' dialog box.

6th If 'Output' box of 'Print Attribute' is selected as 'Printer', click 'Printer Setup' and 'Print Setup' dialog box appears. Select the installed printer, paper, and orientation and click 'OK'.

(It is recommended to select A4 size and portrait direction.)

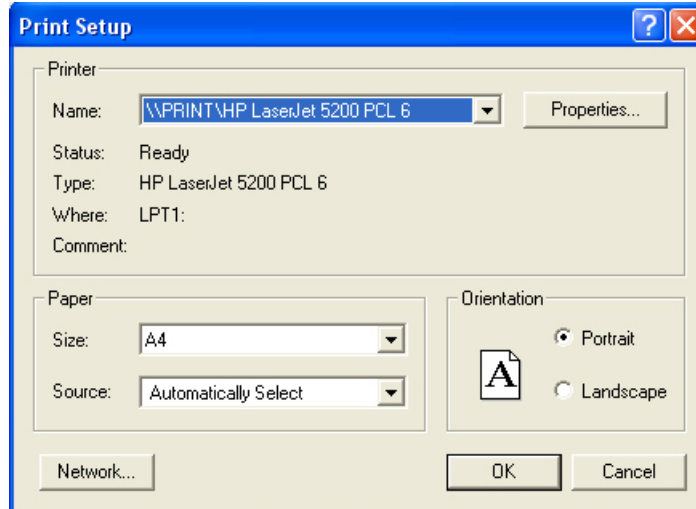

7th Click 'OK' of 'Print Attribute' dialog box and prints these.

2.5.2 Created file when printing as file

Printing as file, 'GPDOC' folder is created in the folder with the current project. Each files and that of description in 'GPDOC' folder is as following.

(For mono type(GP-S044, GP-S057, LP-S044), 'GPDOC' folder is created in the folder with the saved project name folder.)

- project.txt: Creates it when 'Project Information' of 'Print Attribute' dialog box is checked. It maintains common configuration and device list of project.
- BASE1.txt: It is about each base screen in project.
- WINDOW1.txt: It is about each window screen in project.
- Base1.bmp, Base2.bmp, : Image of each base screen
- Window1.bmp, Window2.bmp, : Image of each window screen

2.6 Option

2.6.1 File tab

Check 'Overwriting error message', and it verifies whether to save the project whenever you save the project with 'Project overwrites check' dialog box.

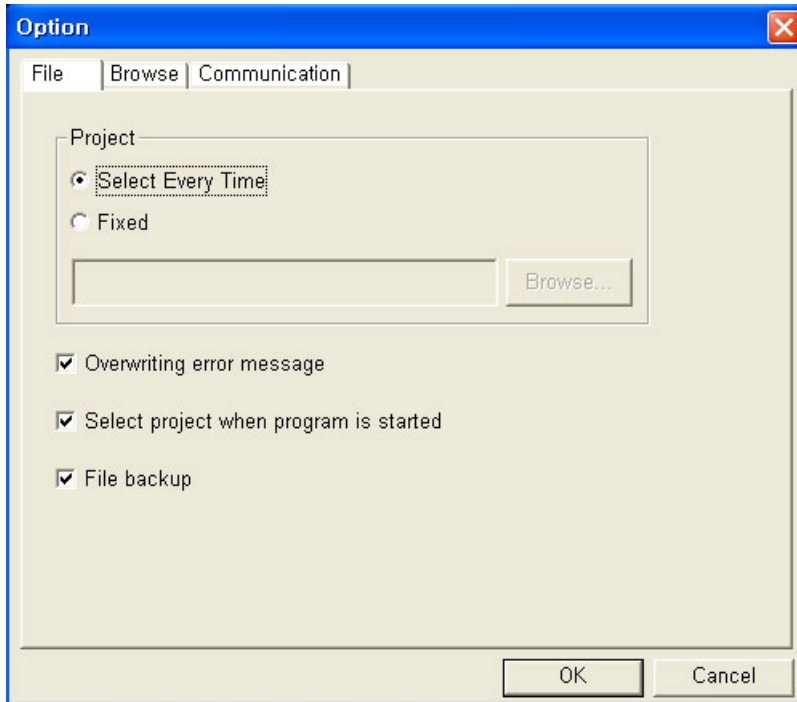

- Mono type(GP-S044, GP-S057, LP-S044)
Check 'File backup', and the backup folder is created under the working folder. Every data of working folder is copied to the backup folder whenever there are save instructions. It is able to protect existing data from saving wrong data.
- Color type(GP-S070, LP-S070)
Project file of color type (GP-S070, LP-S070) is composed of one file as one project. Check 'File backup' and the backup file is created whenever there are save instructions. It is 'Project file name+'_backup'.prj' form.

2.6.2 Browse tab

Grid display, screen magnification, snap, tag ID display and device display are for making screen data efficiently. It is able to configure in 'Browse' tab.

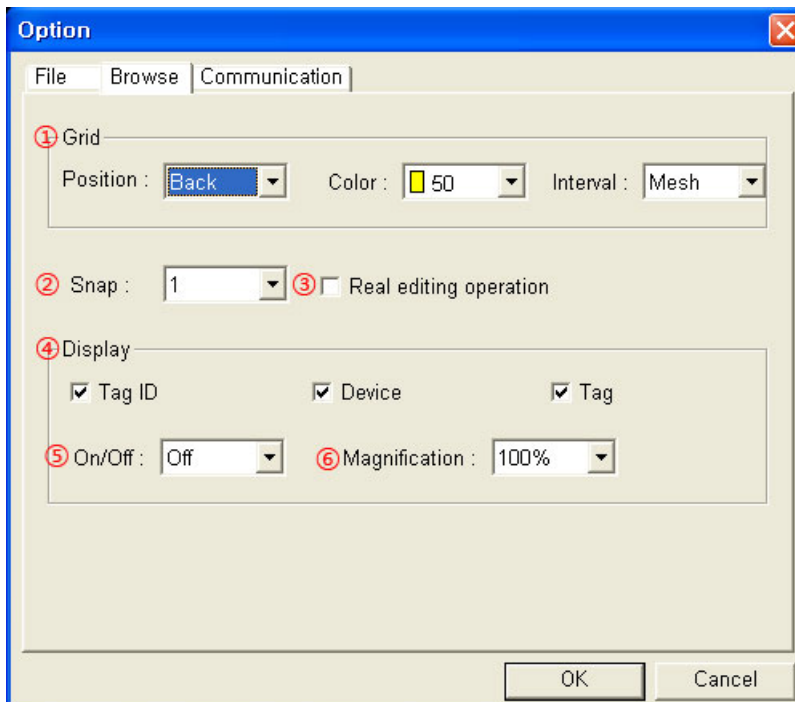

Browse	Description
① Grid	<p>Designate grid for indicating arrangement when editing screen by pull-down menu.</p> <ul style="list-style-type: none"> Position: Front=Displays on the tag, Back=Displays under the tag, None=Does not display Color: White, black, blue, red, pink, light green, light blue and yellow Interval: 2, 4, 5, 8, 10, 16, 20, 40, 80, Mesh
② Snap	<p>Designate snap range of screen by pull-down menu.</p> <ul style="list-style-type: none"> Range: 1, 2, 4, 5, 8, 10, 16, 20, 40, 80, Mesh (A mesh indicates same size of resolution of touch switch.) GP-S057, GP-S070, LP-S070: 20X20 GP-S044, LP-S044: 16X20
③ Real editing operation	<p>Check for displaying object as it is when it is moving, or non-check for displaying only with dotted line.</p>
④ Display	<ul style="list-style-type: none"> Tag ID: Displays tag ID Device: Displays device name related tag. Tag: Displays tag content
⑤ On/Off	<p>Designate ON or OFF image state on edit area by pull-down menu.</p>
⑥ Magnification	<p>Select magnification ration between 100%, 200%, 300%, or 400% based on GP/LP screen size by pull-down menu.</p>

2.6.3 Communication tab

Communication interface and conditions for communication between PC and GP/LP are able to configure in 'Communication' tab.

2.6.3.1 Serial

Communication between PC and GP/LP by serial interface (RS232C, RS422) is available by selecting 'Serial' in 'Communication' tab. You should designate communication conditions such as port and baudrate. Baudrate is designated one of among 9600, 19200, 38400, 57600, 115200 (bps) by pull-down menu.

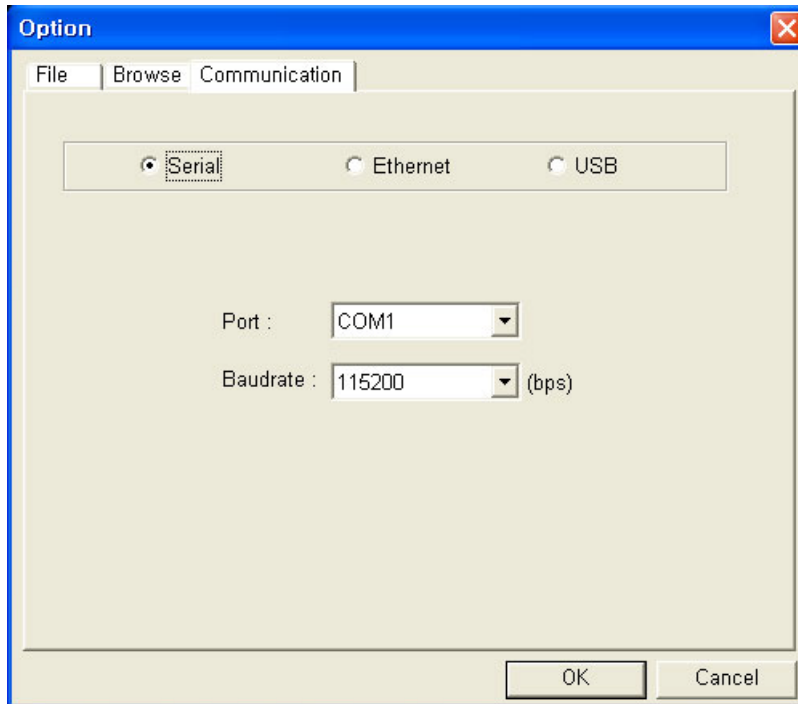

2.6.3.2 Ethernet

Communication between PC and GP/LP by Ethernet interface is available by selecting 'Ethernet' in 'Communication' tab.

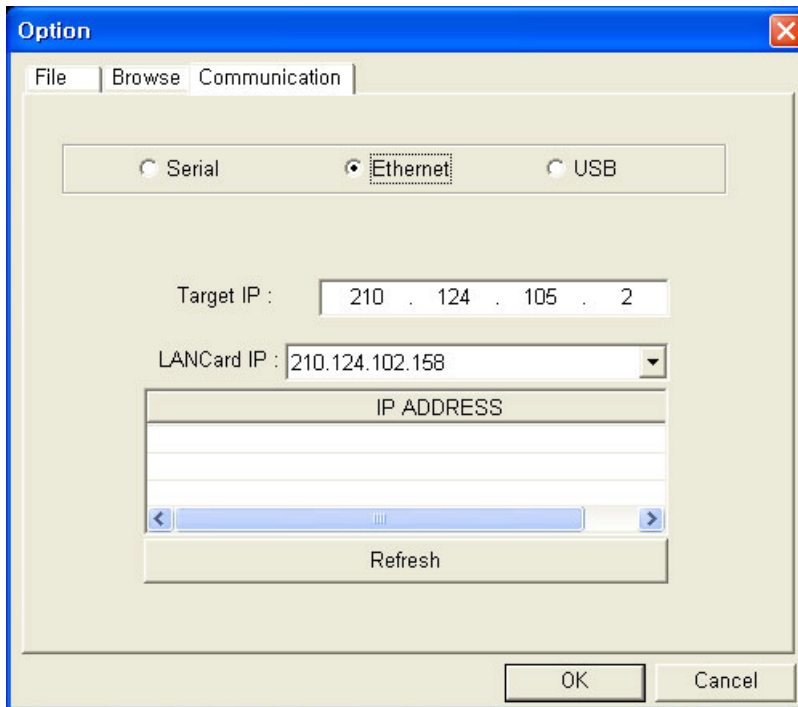

- 1st Select 'Ethernet' and GP/LP list for connected LAN(Local Area Network) is registered automatically on 'IP ADDRESS' list box. If there are not GP/LP list, click 'Refresh' and re-search GP/LP list.
- 2nd Double-click the desired GP/LP from 'IP ADDRESS' list box and the selected IP of GP/LP is set at 'Target IP'.
- 3rd Click 'OK' and it communicates by Ethernet with the set 'Target IP'.

2.6.3.3 USB

Communication between PC and GP/LP by USB interface is available by selecting 'USB' in 'Communication' tab.

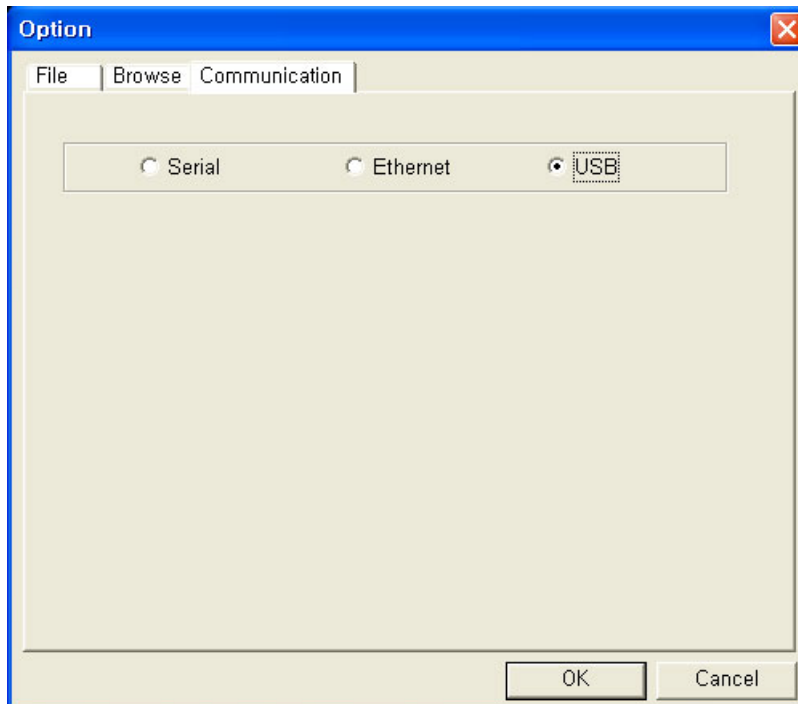

Note

- Communication with USB interface is available only after installing 'GP/LP USB Driver.' Refer to '9.1 USB driver installation' for the details.

2.7 Exit

Select [Project]-[Exit] of menu to edit GP Editor.

If the project is not save before or new screen, it verifies whether to save with the dialog box.

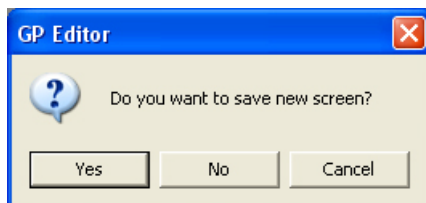

If the project is saved before and there are edited content, the following dialog box appears and verifies whether to save and exits GP Editor.

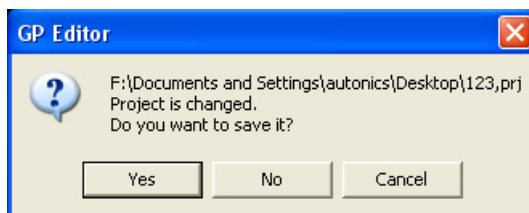

3 Screen

3.1 Screen of GP/LP

It describes the operation of screen specification, creating of screen, load, store and copy. The screen is divided into base screen and window screen. In base screen, it observes arranged graphic objects. The window screen is able to access when touching input object and it is used as key pad.

3.1.1 Base screen

Base screen is for monitoring the connected PLC and available to arrange graphic object. Base screen is downloaded to GP/LP and displays data indication with several method on LCD screen.

The editable base screen depends on the GP/LP model as following.

- GP-S044, LP-S044: 240 X 80
- GP-S057: 320 X 240
- GP-S070, LP-S070: 800 X 480

It is able to design max.500 of base screen with range as 1 to 500.

Each base screen has own screen number. It is controlled by screen number and you can define and adjust the number on GP Editor. When screen switching touch key is designated, it is available to switch screen at GP/LP. User-defined data is downloaded to GP/LP and it displays on the user's screen.

3.1.2 Window screen

Window screen is called when touching numeric or ASCII input tag. The user-defined window is called when inputting decimal, hexadecimal number or ASCII.

The editable window screen depends on the GP/LP model as following.

- GP-S044, LP-S044: 16X20 to 240X80 dots
- GP-S057: 20X20 to 320X240 dots
- GP-S070, LP-S070: 20X20 to 800X480 dots

It is able to design max.500 of window screen in GP editor. (Only three screens are downloaded to GP/LP.)

In accordance with designation in 'Key Window' tab of 'Project Auxiliary Property' dialog box, the window for input type is decided.

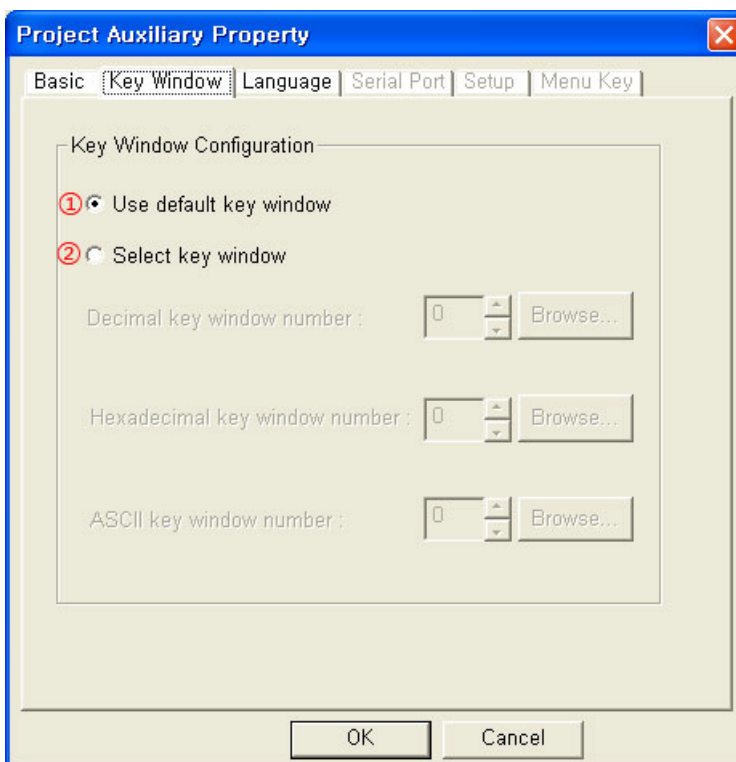

Key Window	Description
① Use default key window	Calls system key window which is supplied from GP/LP
② Select key window	<ul style="list-style-type: none"> ▪ Decimal key window number: Designate window screen number when inputting decimal number ▪ Hexadecimal key window number: Designate window screen number when inputting hexadecimal number ▪ ASCII key window number: Designate window screen number when inputting ASCII <p>If 0 is designated as key window number, the default key window of GP/LP is called.</p>

(1) Key window

Key window is called when touching numeric input or ASCII input object.

Key code input function is for inputting data on input object.

Select [Draw]-[Touch Key] of menu, 'Touchkey property' dialog box appears. At 'Action' tab, check 'Key Code', the spin box is activated. In order to input number or ASCII character, input the appropriate ASCII code. Click 'Browse' and 'Key Code' dialog box appears to select ASCII code. To insert ENT, CLR buttons, select the appropriate ASCII code at 'Function Key Code' tab.

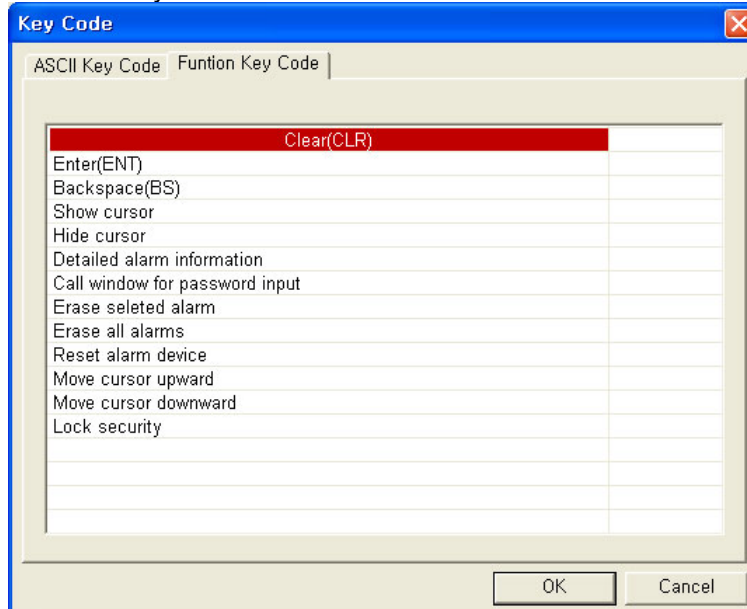

(2) Adjustment of window size

Select [Screen]-[Change Size] of menu, 'Screen Change Size' dialog box appears. It is able to change window size adjusting spin box or slide bar. It is activated only when current editing screen is window.

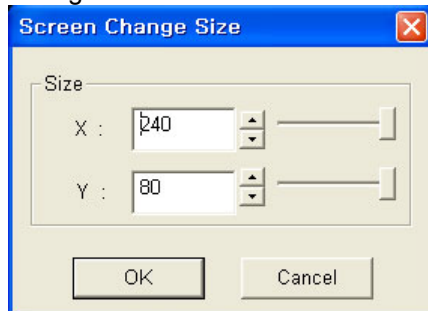

Or drag bottom-left (Indicated with the red circle) of window by mouse, window size is changed.

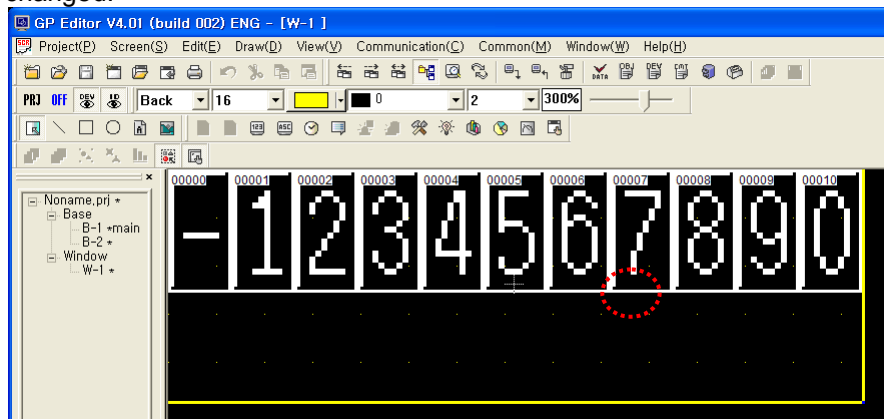

(3) Designate display position of key window

It is able to designate key window position at GP/LP.

At the base screen, select [Draw]-[Key Window Position] of menu, X mark appears with mouse and you can designate key window position. The key window having top-left of X mark appears at GP/LP screen.

If window is exceeded screen range based on this point, it is adjusted inside of GP/LP screen.

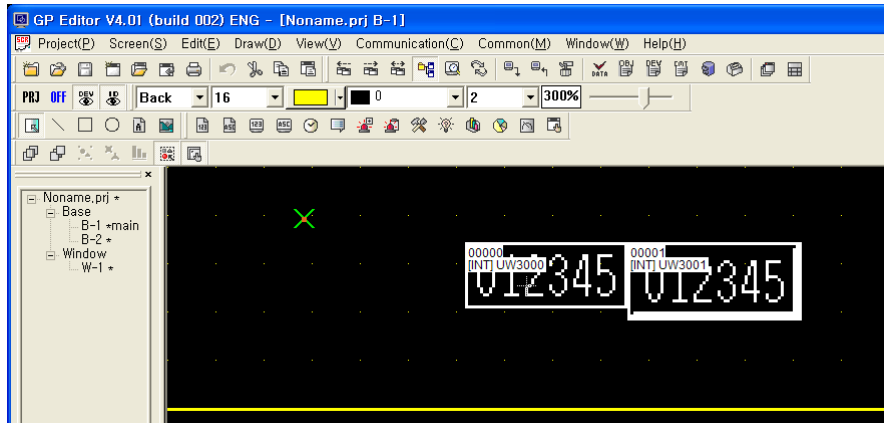

3.2 New Screen

Base screen no.1 is created when project is made.(It does not nessecery to re-make it, except when it is deleted.)

Refer to the following procedure to create new screen.

- 1st Select [Screen]-[New] of menu, 'New' dialog box appears.
- 2nd Select 'BASE' for creating base screen, or 'WINDOW' for creating window screen at 'Screen Type' pull-down menu.
- 3rd Designate screen number at 'Number'.
- 4th Enter screen title at 'Title'.
Title is able to max.32 letters and not necessary to enter. It is information downloaded on the GP/LP memory.
- 5th Enter detail description of screen at 'Detail Description'. It is able to max.512 letters and not necessary to enter.
- 6th Click 'Screen Setting' when screen type is base, 'Screen Auxilairy Configuration' dialog box appears. Designate cursor movement when inputting key window, background color, and security level.
- 7th Click 'Screen Size' when screen type is windos, 'Screen Change Size' dialog box appears. Designate window screen size.
- 8th Click 'OK', new screen is created.

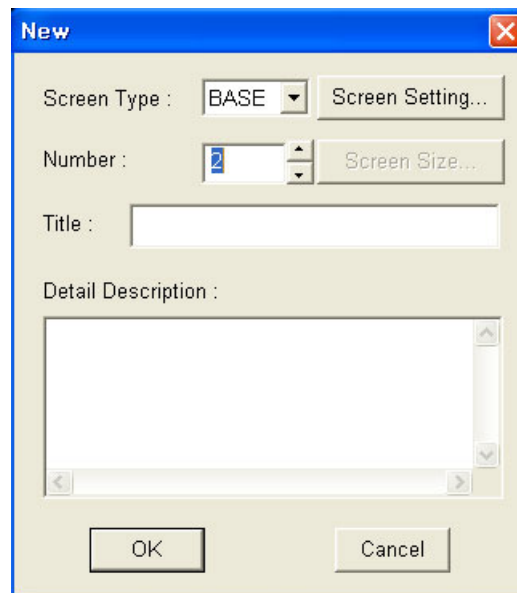

3.3 Load Screen

It load and open the saved screen to edit.

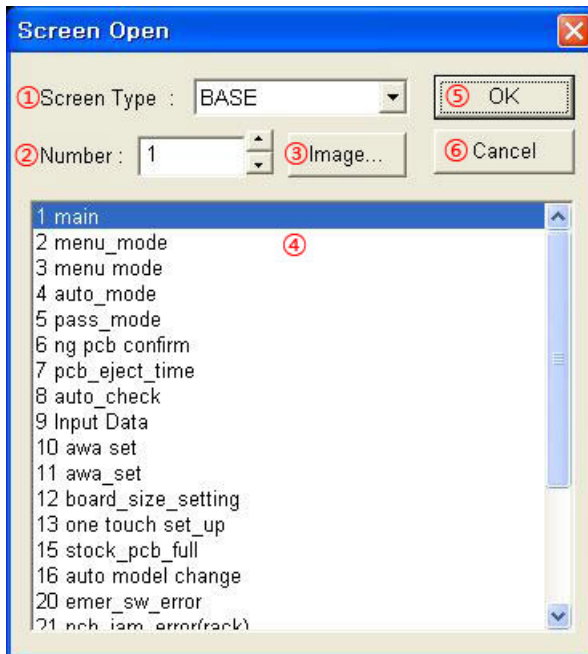

- 1st Select [Screen]-[Load] of menu, 'Screen Open' dialog box appears.
- 2nd Designate screen type at 'Screen Type' pull-down menu. Select 'BASE' for opening base screen, or 'WINDOW' for opening window screen. At the below list box, screen number and titles of project are displayed in order of numbers.
- 3rd Designate screen number to load at 'Number'. Click 'Image', 'SCREEN IMAGE' dialog box appears and you can check all screen images and select screen number.
- 4th Click the desired screen at the below list box. You can select the several screens with dragging or Ctrl key.
- 5th Click 'OK' and the selected screen is loaded.



Screen Open	Description
①Screen Type	Select screen type base screen or window screen to be loaded.
②Number	Designate screen number to import. It is able to designate number inputting by user directly or using spin box. If screen is saved in a project but closed one, it loads again. If screen is not saved in a project but closed one, it creates new screen for input number.
③Image	'SCREEN IMAGE' dialog box appears. It is able to check all screens of project and select screen number.
④List box	The numbers and titles of project are displayed in order of number. Click and select the desired screens with dragging or Ctrl key.
⑤OK	Loads the selected screen.
⑥Cancel	Does not load selected screen and closed 'Screen Open' dialog box.



Note

Click ,  in system tool bar, the lower/higher number of screen than current screen is a editable object. If  is clicked, it opens closed screen and it is a editable object.

3.4 Clear Screen

Click [Screen]-[Clear] of menu, it clears the editing screen. If only one screen is loaded, 'One opened screen cannot be closed' dialog box appears and it cannot be cleared. If editing screen is not a saved state, the save checking dialog box appears and it is able to save.

[Screen]-[Clear] menu executes not only clearing screen, but also closing the opened screens for editing. To delete screen, execute 'Screen Copy/Delete' instructions.

3.5 Load and Clear

Select [Screen]-[Load and Clear] of menu, it closes the current editing screen and 'Screen Open' dialog box appears to load the desired screen.

3.6 Save Screen

Select [Screen]-[Save] of menu, it saves the current editing screen. If there is the saved screen, overwriting check message appears.

The message appears only when from [Project]-[Option] of menu, check 'Overwriting error message' of 'Option' dialog box.

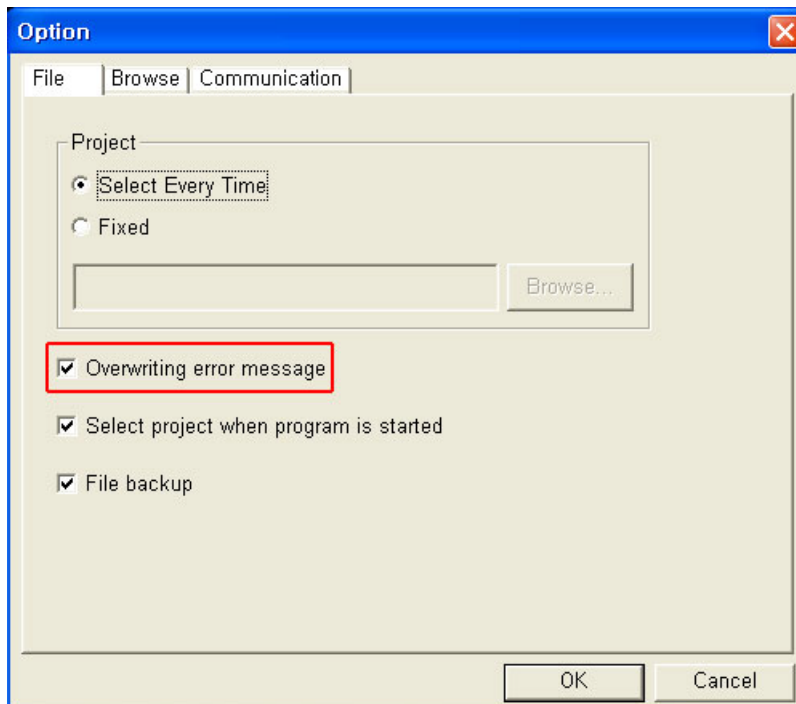

3.7 Save As Screen

It saves the current editing screen as new number of screen.

(1) Operation procedure

- 1st Select [Screen]-[Save As] of menu, 'Save As' dialog box appears.
- 2nd Designate the new number at 'New Number'.
- 3rd To delete existing the current number screen, check 'Delete Previous Screen'.
- 4th Click 'OK', 'Screen Title' dialog box appears.
- 5th Enter or edit title and detail description of screen, click 'OK'. It is saved as a new number screen.

(2) 'Save As' dialog box

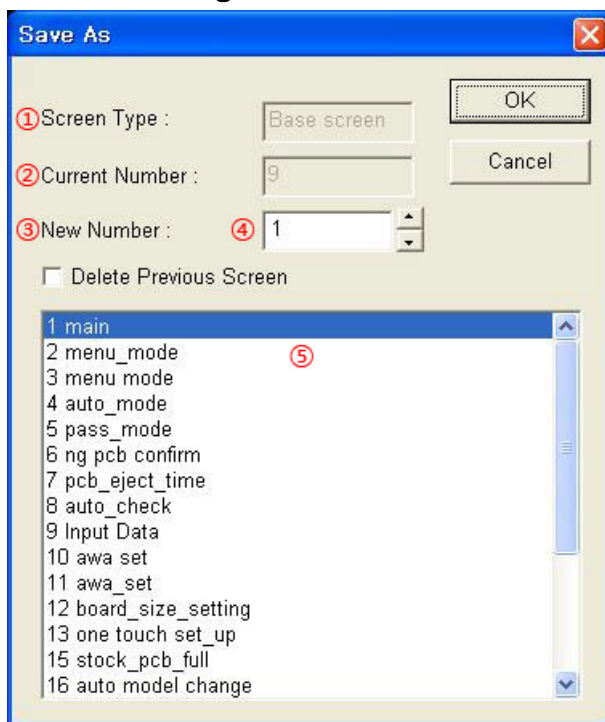

Save As	Description
①Screen Type	Displays screen type (base screen or window screen)
②Current Number	Displays editing screen number.
③New Number	New screen number for storing designated number screen in current number. It is able to designate number inputting in combo box directly, using spin box and selecting in list box.
④Delete Previous Screen	Saves the selected screen as new number screen and deletes previous number screen
⑤List box	Displays screen number and titles of project in order of number. Click the desired number and it is inputted at 'New Number'.

3.8 Screen Copy/Delete

This feature is to delete or copy several screens at once.

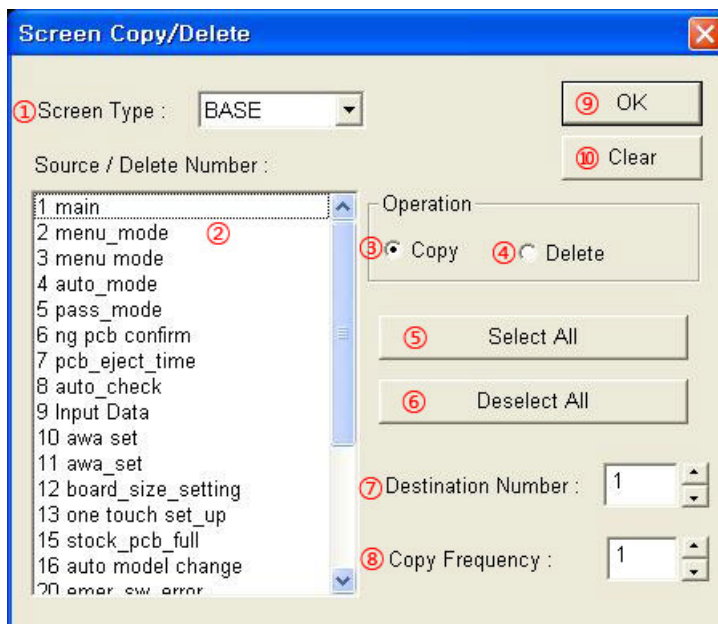

Copy/Delete	Description
① Screen Type	Select screen type(base screen or window screen) to be copied/deleted.
② Source/Delete Number	Displays screens of the project in order of screen number and title. Click the desired screen to copy or to delete. You can select successively screens with pressing Shift key and mouse, or select randomly with pressing Ctrl key and mouse.
③ Copy	Copy selected screen in a list to the number of screen inputted in destination number. Selected screens are copied as many as copy frequencies repeatedly from the destination number. Ex) Selected screen=1,4,5, Destination number=10, Copy frequency=3 Screen#10←Screen#1, Screen#13←Screen#4, Screen#14←Screen#5, Screen#15←Screen#1, Screen#18←Screen#4, Screen#19←Screen#5, Screen#20←Screen#1, Screen#23←Screen#4, Screen#24←Screen#5 If there is a written screen already in the destination screen, it shows a overwrite warning message to cancel copy.
④ Delete	Deletes all selected screens in list. ⑦ Destination number and ⑧ Copy Frequency is not activated.
⑤ Select All	Selects all items in list box.
⑥ Deselect All	Deselects all items in list box.
⑦ Destination Number	Designates screen number to paste selected number of screen in list box. If inputted number of screen is already in the project, overwrite checking message appears. If the screen does not exist, it creates new screen and copies.
⑧ Copy Frequency	Enters repeat frequency for copy inputted number of screen in a destination number.
⑨ OK	Executes screen copy/delete.
⑩ Clear	Closes 'Screen Copy/Delete' dialog box.

3.9 Change Size

Select [Screen]-[Change Size] of menu, 'Screen Change Size' dialog box appears. It is able to change window size adjusting spin box or slide bar. [Change Size] menu is only activated when editing screen is window, not base.

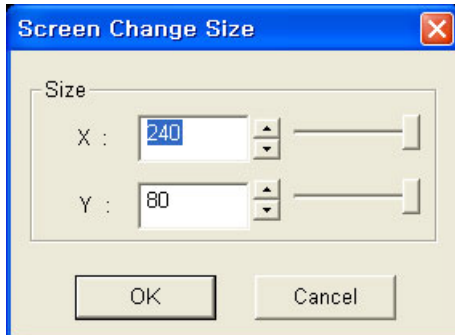

4 Edit

In this chapter, it describes basic editing function of GP Editor.

4.1 Undo

It is able to return to the before operation state undoing the previous operation such as deletes the object on a screen, changes size or position. (It is applied once.)

[Edit]-[Undo] of menu is activated after deleting the object or changing size or position. Click this or press Ctrl+Z to execute.

It is not able to undo in case of adjusting the size of object having character or changing the property through the window.

4.2 Cut

Select [Edit]-[Cut] of menu or press Ctrl+X to delete selected object on a screen. Cut object is copied on a clipboard and paste function is activated after this execution. It is able to arrange cut objects on a screen again with paste command.

4.3 Copy

It copies selected objects to clipboard. Select [Edit]-[Copy] of menu or press Ctrl+C. It is able to create objects with same property arranging on a screen with paste command.

4.4 Paste

It pastes copied objects on a clipboard by cut or copy on a screen. Select [Edit]-[Paste] of menu or press Ctrl+V. It is able to create objects with same property arranging on a screen with paste command.

Copy and paste is only available at the current project. It is not available to copy or paste the other project's tag. To copy or paste the other project's tag, refer to '2.4 Import Project'.



Note

When pasting the object which can exist only one on a screen into the two objects, or the object which cannot exist on a screen into existing together, paste instruction is not worked.

- Object which can exist only one on a screen: Alarm history, alarm list with scroll option, trend graph, line graph and key window position mark
- Object which cannot exist on a screen: Alarm history, alarm list with scroll option, trend graph and line graph

4.5 Successive Copy

It copies selected objects successively and arranges on a screen. Select [Edit]-[Successive Copy] of menu and 'Successive Copy' dialog box appears. Designate number of copy, space(dot), address increment etc., and click 'OK' to execute.

Successive Copy	Description
① Number Of Copy	<ul style="list-style-type: none"> X: Designate the number of objects to copy with horizontal direction. Y: Designate the number of objects to copy with vertical direction
② Space(dot)	<ul style="list-style-type: none"> X: Designate the space between objects of horizontal direction as dot units. Y: Designate the space between objects of vertical direction as dot units.
③ Address Increment	<ul style="list-style-type: none"> Not: It does not increase the object address to be copied. The figure object is fixed as Not. X Priority: Copies to the horizontal direction increasing object address. Y Priority: Copies to the vertical direction increasing object address. Increment (Decimal): Increases the address by designated unit.
④ OK	Executes to copy and closes the dialog box
⑤ Cancel	It does not execute to copy and closes the dialog box



Ex.

If the object configured as D100 is specified at 'successive copy' dialog box as following,

Number of copy (X= 4, Y=3), Space(dot) (X=2, Y=3), Address increment (Increment (Decimal)=1)

The object is copied as following.

Total $X \times Y = 12$ of objects are created and adjacent two objects have 2 dots space for horizontal direction, 3 dots space for vertical direction. In this case for address increment, 'X Priority' is selected, address is increased to the horizontal first (black font). 'Y Priority' is selected, address is increased to the vertical first (italics font).

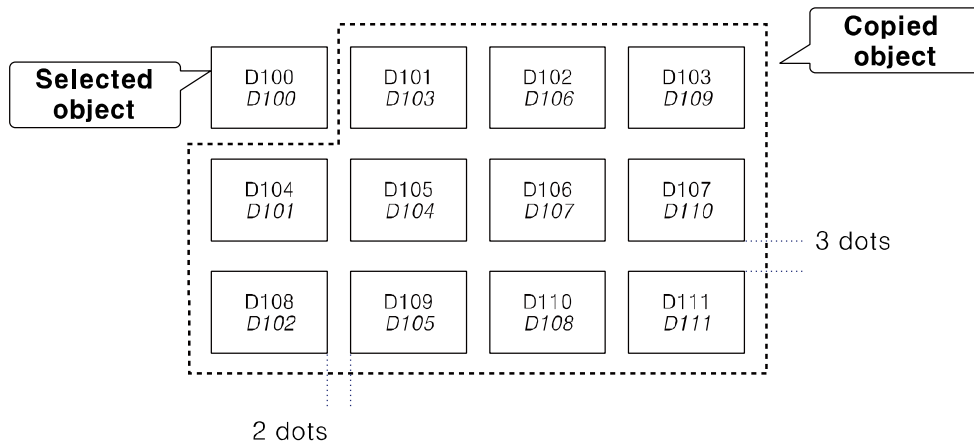

Note

- It is applied same when an object or several objects are selected. It is applied to all figures and tags.
- If the object to be copied exceeds the working area, error message appears and this instruction is not executed.
- When successive coping tag with address, if it exceeds address range error message appears and this instruction is not executed.
- When pasting the object which can exist only one on a screen into the two objects, or the object which cannot exist on a screen into existing together, paste instruction is not worked.



4.6 Delete



It deletes the selected object on a screen. Select [Edit]-[Delete] of menu, or press Delete key. To return to the deleted object, execute undo instruction.

4.7 Select All

Select [Edit]-[Select All] of menu or press Ctrl+A, all object on a screen are selected. In this case, the object to be subjected of selection condition is selected.

4.8 Select Object

Select [Edit]-[Select Object]-[Figure]/[Tag] of menu or click  or  in edit toolbar. It is useful to separate and edit a figure object or tag only when figure and tag are existed closely.

		Selected object
Press	Release	Selects only figures
Release	Press	Selects only tags
Press	Press	Selects all objects
Release	Release	Does not select any objects

- Movement of object

- 1st Click the object with right mouse button and the object is selected. The selected object indicates marks for adjusting size as following figure.

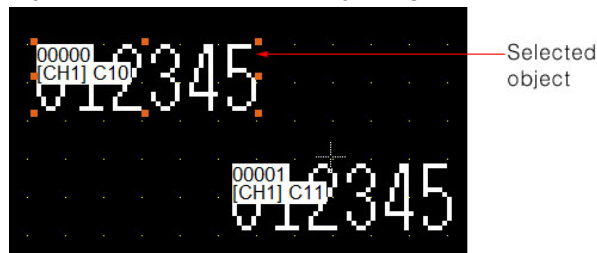

- 2nd Click with left mouse button and drag for the desired area, dotted square is following.

Release the mouse button, inside objects of dotted square are selected.

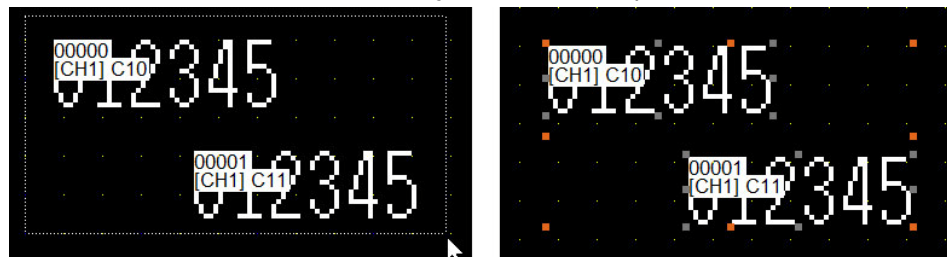

3rd Click the selected object and mouse cursor for movement appears. Drag the cursor, the dotted line of selected object follows. Release mouse button to the desired position, the object is moved to that position.

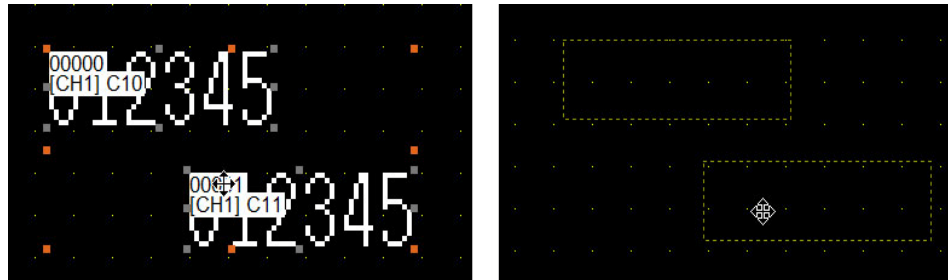

Note

To show the real editing operation state of object, select [Project]-[Option] of menu, 'Option' dialog box appears. At 'Browse' tab, check 'Real editing operation', and when moving the object, it shows the real editing operation status of object.

The selected object displays mark to adjust size as following figure. There is a mark to adjust on each summit and side. When moving a cursor to the mark, other shape of cursor is appeared as second figure.

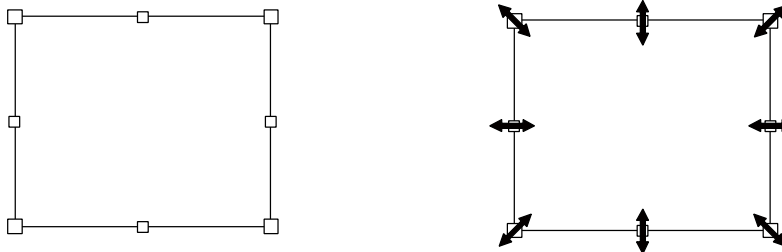

- ↔ Adjusts the width of selected object
- ↕ Adjusts the height of selected object
- ↗ Adjusts both the width and height of selected object
- ↘ Adjusts both the width and height of selected object

4.9 Group

Select [Edit]-[Group] of menu to group more than 2 objects as one. Existing group can be a factor of a new other group.

Grouped object is recognized as an object and all functions such as copy, cut, bring forward, or send backward are applied.

- Inner figure and tag property of grouped object is kept continually.
- Tag ID is given upper ID automatically than currently designed tag and later designed tag is arranged on the upper part in turns.
- The stacking order of objects in a group is preserved when grouping, but the stacking order is changed as group objects put on the upper part than not grouped objects. ID is changed as higher value.

For example, if a tag is grouped with group instruction, the ID of the tag is changed to have higher value than not grouped other tags. It is applied same to figure object.

Tag arrangement before grouping	
After grouping ①, and ②	
After grouping ③ and ④	

- Group objects are registered on panel kit to use.
- The group of figure objects is registered on part library to use.
- When group object registered in panel kit and part library is arranged on a screen, it preserves group information.
- When uploading group object on GP/LP screen, it preserves the group information in download.
- It is able to adjust size of figure object.

4.10 Ungroup

Select group object and select [Edit]-[Ungroup] of menu, it separates each object as previous state.

4.11 Bring Forward/Send Backward

Bring forward instruction changes stacking order for the selected object to bring forward. Send backward instruction changes stacking order for the selected object to send backward.

(1) Figure and tag

Tag has higher priority than figure object, it is always displayed in front of figure.

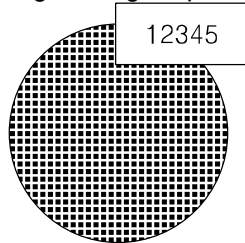

(2) Figure and figure, tag and tag

The stacking order between figure and figure object, tag and tag is decided as the latest created one has high priority. The later one is able to hide the previous one.

(3) Overlap screen

Base screen has a higher order than overlapped screen, it is displayed in front of overlap screen. Figure and tag of base screen are put in front of figure and tag of overlap screen. If there are more than two overlap screens, later overlapped screen object is on the front. When there are two overlap screens, it is displayed as following order.

Tag of base screen → Figure of base screen → Tag of overlap screen2 → Figure of overlap screen2 → Tag of overlap screen1 → Figure of overlap screen1



Note

- It is not able to change the order between figure and tag with bring forward, send to backward instruction.
- The stacking order of figure is changed with bring forward instruction; it is put on the front among figures but it cannot be placed in the front for any tags.
- The stacking order of tag is changed with send backward instruction; it is put on the behind among tags but it is put on the front than any figure.
- When executing bring forward, send to backward instruction after selecting several objects, the stacking order between selected objects is kept and it is put on the front or on the behind than not selected objects.
- If selecting overlap screen and executing send to backward instruction, it is put on the behind among overlap screens.
- The stacking order of group and tag
The order between two is decided by bring forward or send backward instruction. Tag is placed on the upper than figure regardless with single object of tag or object including tag.

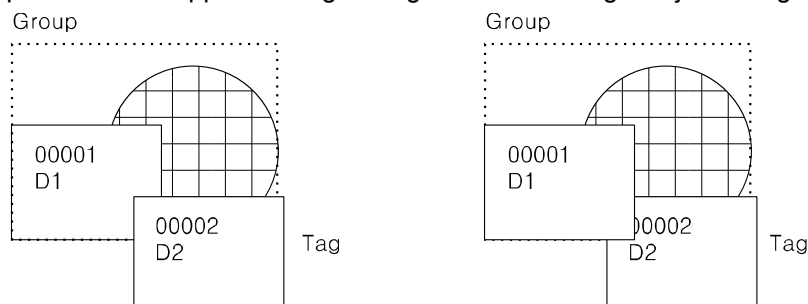

- Figure included in a figure or group

The order between two is decided by bring to forward or send to backward instruction, figure is placed on the lower than tag.

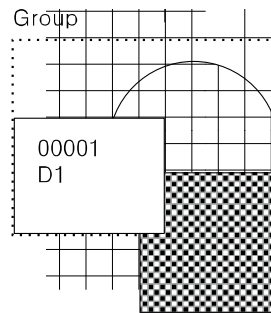
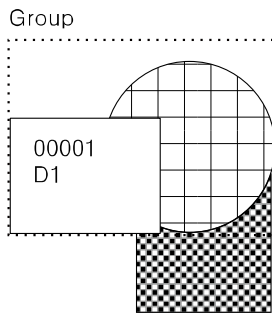

4.12 Replace Device

It is able to replace device using in a project collectively. Select [Edit]-[Replace Device] of menu, 'Replace Device' dialog box appears.

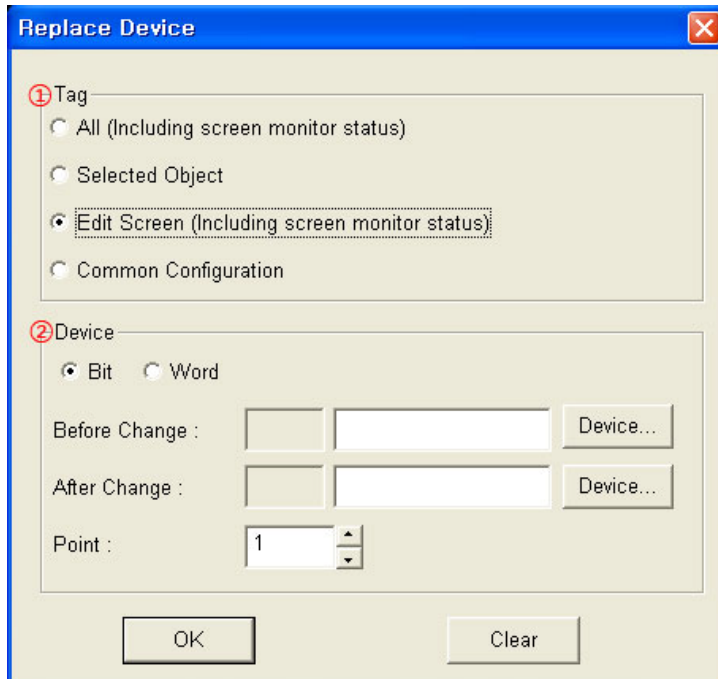

Replace Device	Description
① Tag	<p>Designate tag to replace device according to Tag group box.</p> <ul style="list-style-type: none"> All (Including screen monitor status): Replaces tag devices on all base screens in a project. All devices configured about each base screen designated at 'Screen' tab of 'Monitor Status' dialog box are replaced. Selected Object: Replaces selected tag device of the current editing screen. Edit Screen (Including screen monitor status): Replaces tag device on a editing screen. All devices configured about current editing screen designated at 'Screen' tab of 'Monitor Status' dialog box are replaced. Common Configuration: Replaces tag device of common configuration.
② Device	<ul style="list-style-type: none"> Bit/Word: Select bit or word device Before Change/After Change: Changes device designated in Before Change as device designated in After Change. Point: Designates the number of device to be changed.

 **Note**

Default configuration according to calling 'Replace Device' dialog box

When selecting [Edit]-[Replace Device] of menu,

(a) Edit screen as default when there are not selected tags

(b) Selected objects as default when there are selected tags

When lead device and destination device designated point are out of range, the following message appears and asks change the device within range or not.

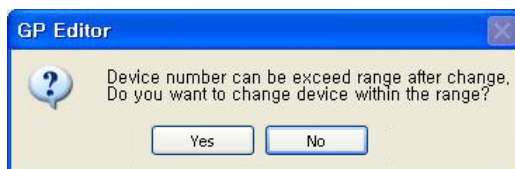

4.13 Replace Overlap Screen

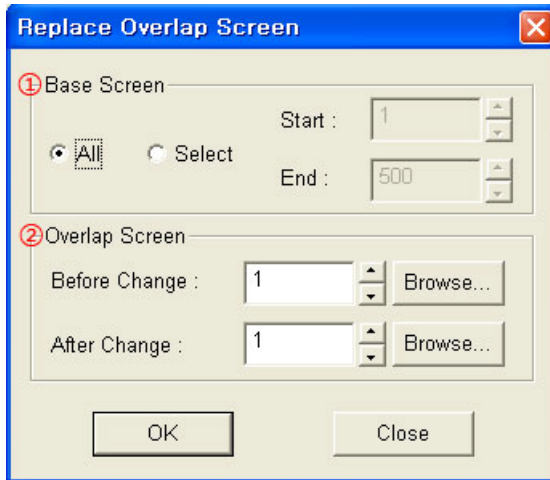

Replace Overlap Screen	Description
① Base Screen	Designates overlap screen range to replace <ul style="list-style-type: none"> All: Replaces overlap screens of all base screens in a project Select: Replaces the overlap screens of the designated base screens which has Start to End range in a project
② Overlap Screen	Designates overlap screen number to replace Replaces from Before Change of overlap screen number to After Change of overlap screen number

4.14 Attribute

Select the object and select [Edit]-[Attribute] of menu, click the object with right mouse button and pop-up menu appears and select [Attribute], double-click the object, or after selecting the object and press Alt+Enter, and the object 'Property' dialog box appears.

If executing attribute instruction when overlap screen is selected, 'Overlap' dialog box appears with the overlap screen selected state.

4.15 Alignment

It is useful to arrange objects as up/down/left/right when several objects are on a screen.

Select [Edit]-[Alignment] of menu, and 'Alignment' dialog box appears. After the desired alignment setting and click 'Apply' and 'OK' to complete alignment.

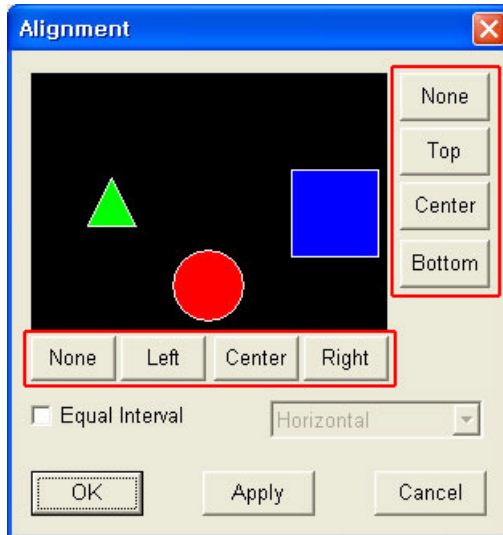

(1) Horizontal alignment

- None
There is no horizontal alignment.
- Left
It moves top-left X coordinate of selected all objects to make same as X coordinate of top-left of leftmost object with horizontal way.

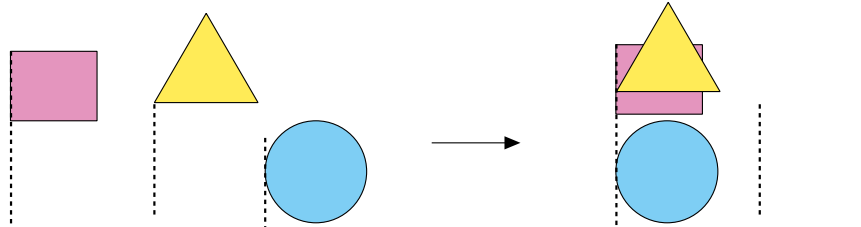

- Center
It moves central point X coordinate of selected all objects to make same as an average of top-left X coordinate of leftmost object and rightmost object with horizontal way.

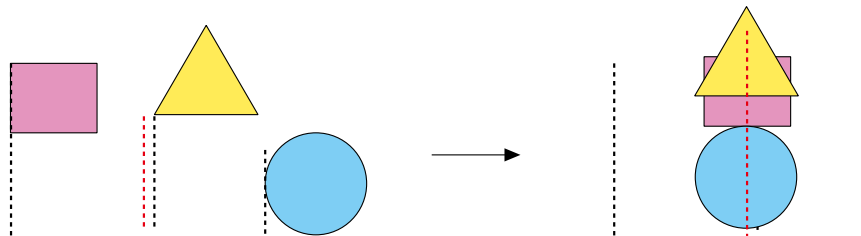

- Right

It moves top-right X coordinate of selected all objects to make same as top-right X coordinate of rightmost object with horizontal way.

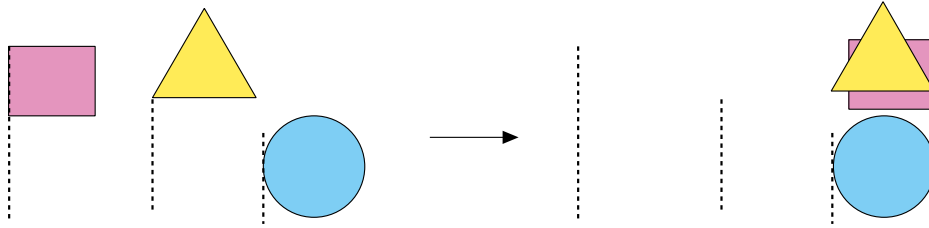

(2) Vertical alignment

- None

There is no vertical alignment.

- Top

It moves top-left Y coordinate of selected all objects to make same as top-left Y coordinate of topmost object with vertical way.

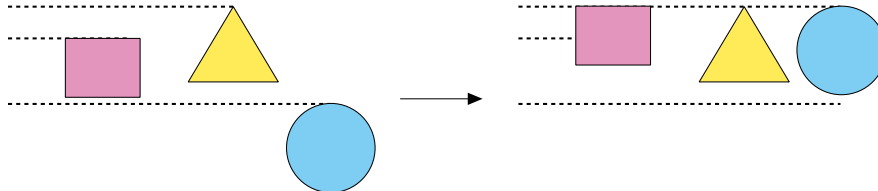

- Center

It moves central point Y coordinate of elected all objects to make same as an average of top-left Y coordinate of topmost object and bottommost object with vertical way.

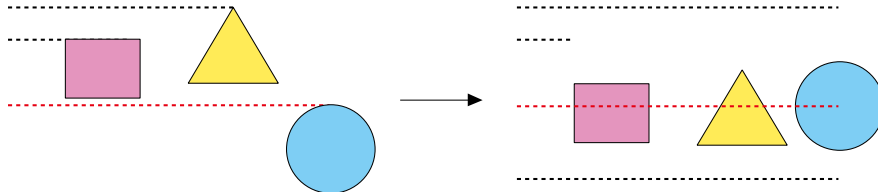

- Bottom

It moves top-left Y coordinate of selected all objects to make same as top-left Y coordinate of bottommost object with vertical way.

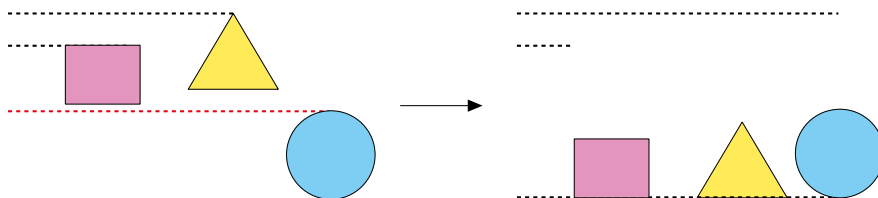

(3) Equal Interval

▪ Horizontal

Leaving objects with left end of X coordinate on leftmost and rightmost among selected objects, move other objects as horizontal way to make left end of X coordinate of other objects to position equally between left end of X coordinate of two objects.

If left end of X coordinate among more than 2 objects is same, front part of object is moved to the right. When right end of X coordinate of moving object is out of the right border, right end of X coordinate is on a border.

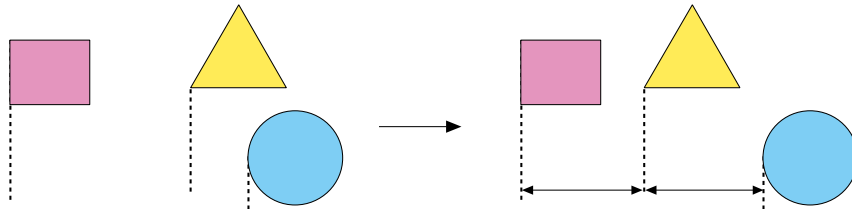

▪ Vertical

Leaving objects with top end of Y coordinate on topmost and bottommost among selected objects, move other objects as vertical way to make top end of Y coordinate of other objects to position equally between top end of Y coordinate of two objects.

If left end of Y coordinate among more than 2 objects is same, front part of object is moved to the bottom. When bottom end of X coordinate of moving object is out of the bottom border, bottom end of Y coordinate is on a border.

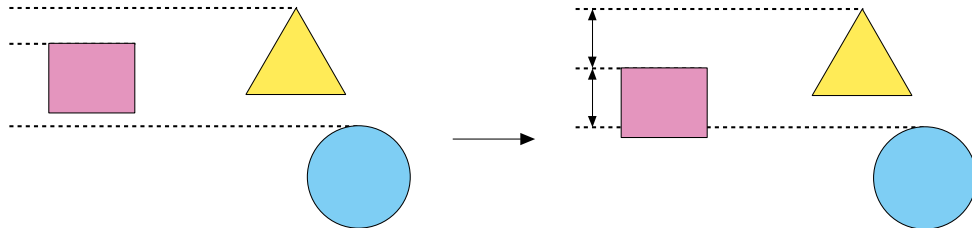

5 Draw

In this chapter, it describes basic operation of tag arrangement on a screen.

5.1 Panel kit/Part

Panel kit/Part library is a library to reuse frequently used figures and tags easily. There are three types of panel kit/part library.

(1) Panel kit library

Panel kit library is user-made library and able to register frequently used figures and tags as library part. It is able to make max.50 libraries and to utilize to other projects after making it. It is able to save as a separate file and loaded saved library to use.

(2) Part library

It is not able to edit because it is a basic library supported by GP Editor. It is not able to user edit or copy any library and library image in part library but user can design in panel kit.

(3) Part

It is able to register several numbers or groups of figure object (line, rectangle, circle, text, BMP) and it is used in part display, lamp, and touch key tag. It is required to register separately for each project and it can be imported from other project. All parts are downloaded to GP/LP.

5.1.1 Panel kit

Panel kit 'Library' dialog box is modeless dialog box which enable to edit continue. It executes all operation about panel kit, part library, and part. Select [Draw]-[Panel Kit]/[Part] of menu, or click  in toolbar, Panelkit/Part 'Library' dialog box appears.

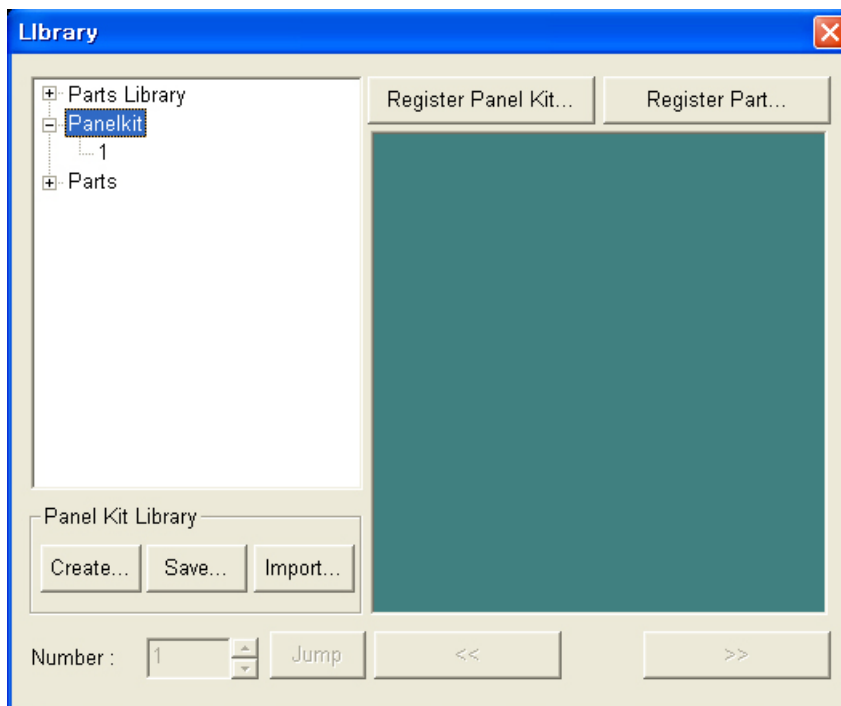

5.1.1.1 Draw

- 1st At tree view of 'Library' dialog box, select parts library, panel kit, or parts and lower folder. The selected folder library's items are displayed at image view.
- 2nd Select the desired item from image view.
- 3rd Place mouse cursor to edit area. Dotted outline follows mouse cursor.

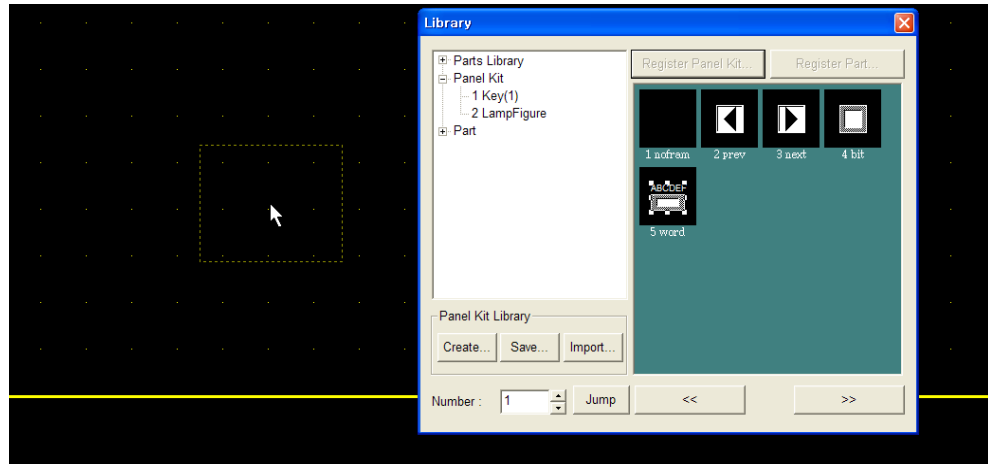

- 4th Click mouse button, and the desired panel kit/part item is placed.

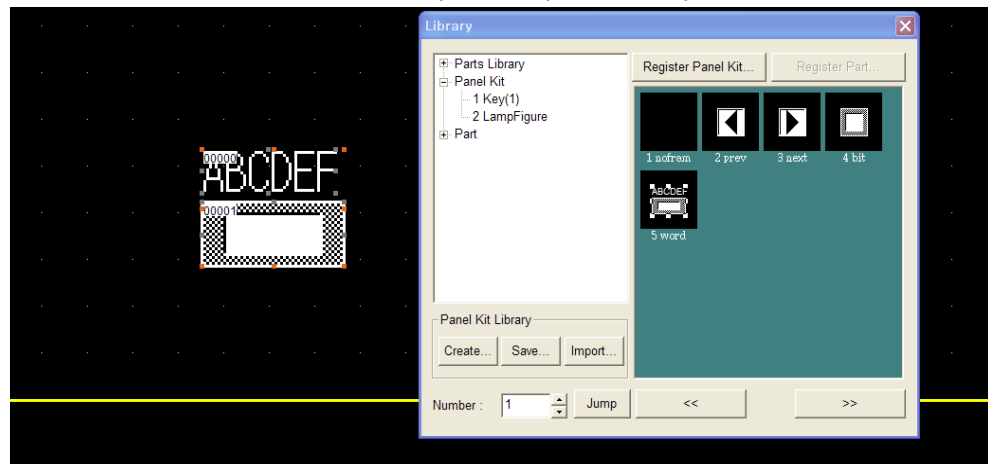

5.1.1.2 Create/Delete

- Create

1st Click 'Create' of 'Library' dialog box, 'Panelkit Library' dialog box appears.

2nd Designate library number to 'Library No.' and library name to 'Library Name' to create the designated library.

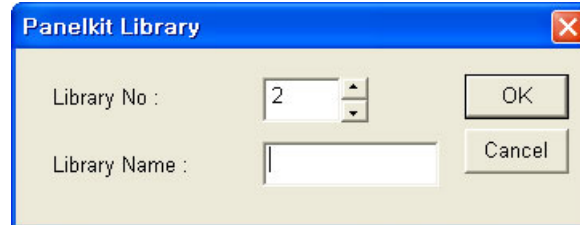

- Delete

1st Select the desired library to delete at image view.

2nd Click right mouse button, pop-up menu appears.

3rd Select 'Delete' and library is deleted.

5.1.1.3 Save/Import

After panel kit library is registered first, every project can import the library. You can save the library as file and manage it.

- Save

1st Click 'Save' at 'Panel Kit Library' box of 'Library' dialog box.

2nd 'Save Panel Kit' dialog box appears. Select the library to save at 'Library Name' list box.



3rd Click 'Browse' and designate the path to save.

4th Click 'Save' and each library is saved as 'PKITxx.xml' file on the designated path. xx of the next PKIT means the selected library number.

- Import

1st Click 'Import' at 'Panel Kit Library' box of 'Library' dialog box.

2nd 'Import Panel Kit' dialog box appears. Click 'Browse' and designate the path to import panel kit library.

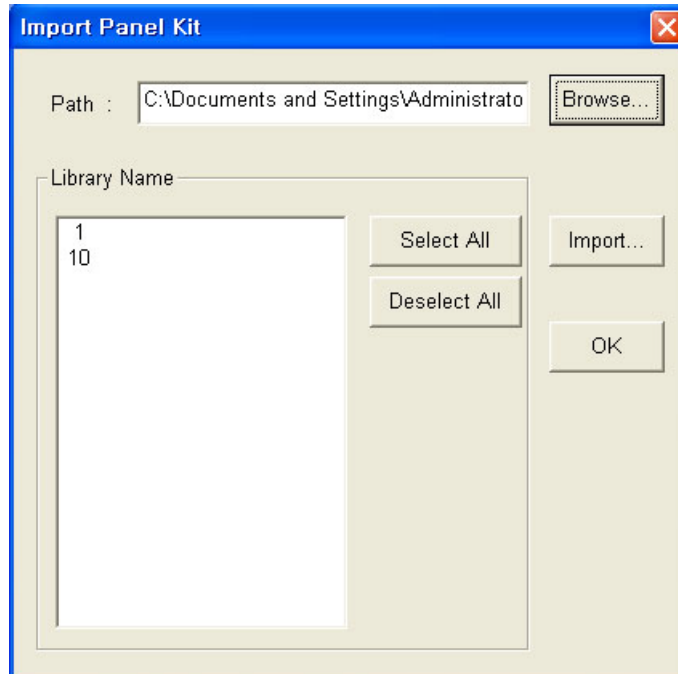

3rd 'Library Name' list box displays the designated panel kit library.

4th Select the library to import at 'Library Name' list box, and click 'Import'.

Every library of selected library file is imported to editing screen. After this, you can use the library.

5.1.1.4 Register panel kit/Delete/Copy

- Register

Panel kit is able to register as part when several numbers or groups of only figure objects (line, rectangle, circle, Text, BMP) are selected.

1st Select the object to register as panel kit on edit screen. 'Register Panel Kit' is activated only when there is selected object.

2nd Click 'Register Panel Kit' and 'Edit Panelkit' dialog box appears.

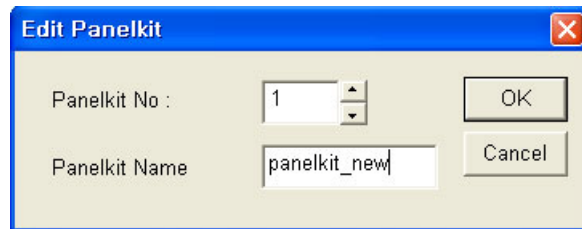

- ♦ Panel Kit Number: Panel kit number at the registered library
- ♦ Panel Kit Name: Panel kit name

3rd Designate panel kit number and name and register it. If there is already the designated panel kit number, overwrite check message appears.

4th Panel kit is registered.

- Delete

1st Select the object at image view.

2nd Click right mouse button, pop-up menu appears and select 'Delete'.

3rd The object is deleted.

- Copy (Register as other name)

1st Select the object at image view.

2nd Click right mouse button, or press Ctrl+C. Pop-up menu appears and select 'Copy'.

3rd 'Panelkit Copy' dialog box appears and select the desired item to copy.

5.1.2 Part

The descriptions of draw, register, copy, or delete part are same with those of panel kit. Please refer to '5.1.1 Panel kit'.

5.2 Line

Draws line with one dot thickness on screen.

5.2.1 Basic usage

1st Select [Draw]-[Line] of menu, or click  in toolbar, mouse cursor for drawing mode appears at edit area.

2nd Place mouse cursor on a start point of straight line and press left mouse button.

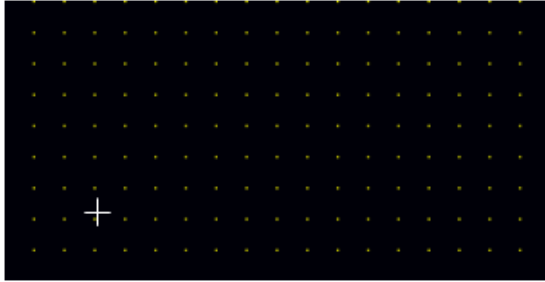

3rd Press left mouse button and drag cursor to the end point of the line. A dotted line appears up to current cursor position.

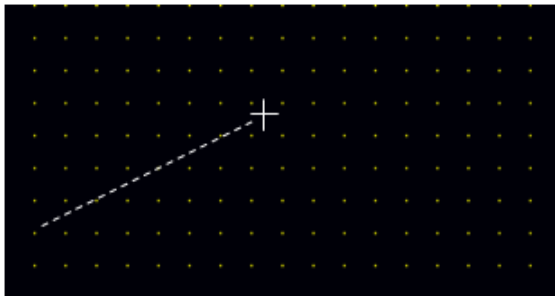

4th Release mouse button and a line is drawn.

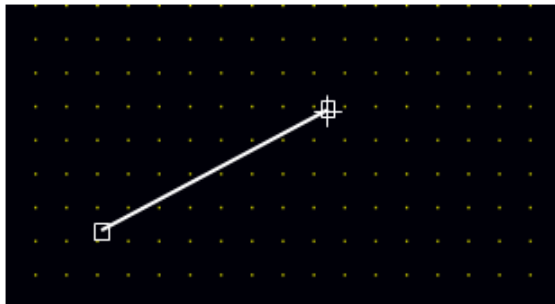

5th For changing color or style of line, double-click the line and 'Line Property' dialog box appears. You can designate the desired color and style.

5.2.2 Property

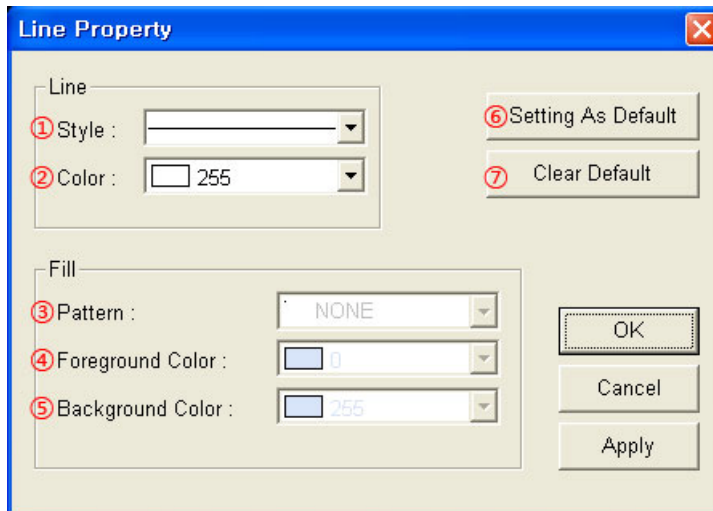

Item	Description
①Style	Designate one line style of solid, dotted, broken, dot chain, two dot chains by pull-down menu.
②Color	Designate line color. <ul style="list-style-type: none"> ▪ Mono type(GP-S044, GP-S057, LP-S044): White/Black ▪ Color type(GP-S070, LP-S070): 24bit True Color
③ to ⑤	Not used
⑥Setting As Default	Draw next line as currently designated style and color.
⑦Clear Default	Draw next line as ①Style: Solid, ②Color: White.

5.3 Rectangle

Draws rectangle with one dot thickness outline on screen. You can change the desired color and style of outline and designate inside pattern, foreground color, and background color.

5.3.1 Basic usage

1st Select [Draw]-[Rectangle] of menu, or click  in toolbar, mouse cursor for drawing mode appears at edit area.

2nd Place mouse cursor on a edge point of rectangle and press left mouse button.

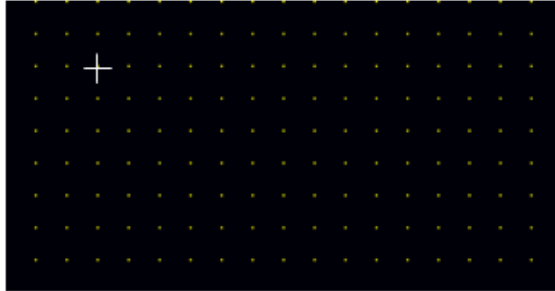

3rd Press left mouse button and drag cursor to the diagonal edge point of rectangle. A dotted rectangle appears.

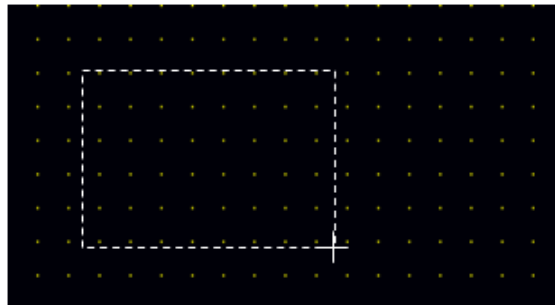

4th Release mouse button and rectangle is drawn.

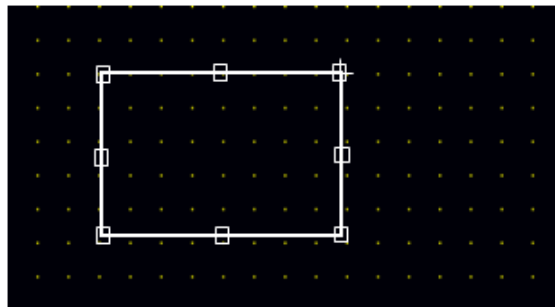

5th For changing color or style of rectangle, double-click 'Rectangle Property' dialog box appears. You can change the desired color and style of outline and designate inside pattern, foreground color, and background color.

5.3.2 Property

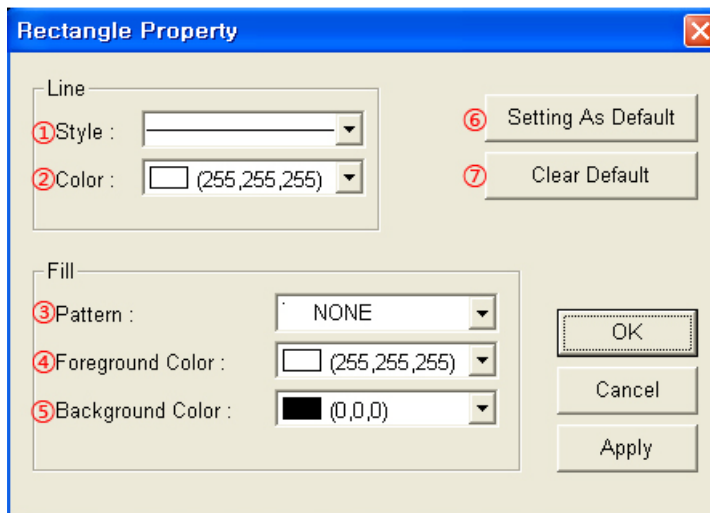

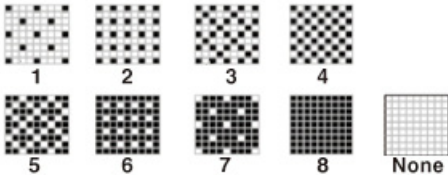
Item	Description
①Style	Designate outline style by pull-down menu. Setting range is same with that of line.
②Color	Designate outline color <ul style="list-style-type: none"> ▪ Mono type(GP-S044, GP-S057, LP-S044): White/Black ▪ Color type(GP-S070, LP-S070): 24bit True Color
③Pattern	Select one pattern of rectangle to fill inside by pull-down menu. 
④Foreground Color	Designate foreground color <ul style="list-style-type: none"> ▪ Mono type(GP-S044, GP-S057, LP-S044): White/Black ▪ Color type(GP-S070, LP-S070): 24bit True Color
⑤Background Color	Designate background color <ul style="list-style-type: none"> ▪ Mono type(GP-S044, GP-S057, LP-S044): White/Black ▪ Color type(GP-S070, LP-S070): 24bit True Color
⑥Setting As Default	Draw next rectangles as currently designated settings
⑦Clear Default	Draw next rectangles as following. ①Style: Solid, ②Color: White, ③Pattern: None, ④Foreground Color: White, ⑤Background Color: Black

5.4 Circle

Draws circle or oval with one dot thickness outline on screen. You can change the desired color and style of outline and designate inside pattern, foreground color, and background color.

5.4.1 Basic usage

1st Select [Draw]-[Circle] of menu, or click  in toolbar, a mouse cursor for drawing mode appears at edit area.

2nd Place mouse cursor to the desired area and press left mouse button.

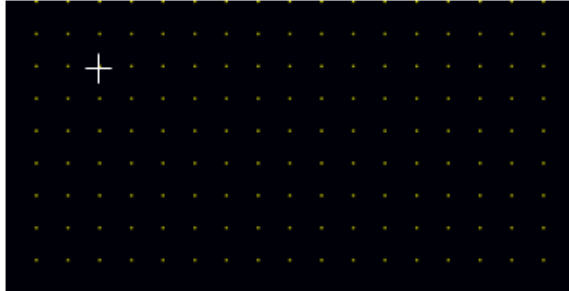

3rd Press left mouse button and drag cursor as the desired size. A dotted circle appears.

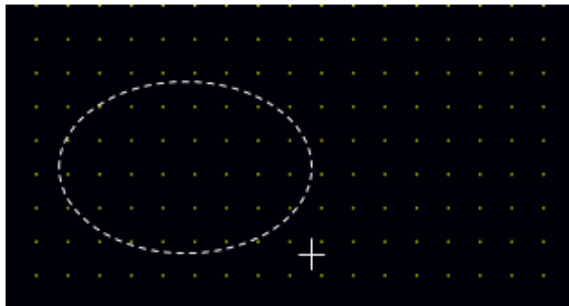

4th Release mouse button and a circle is drawn.

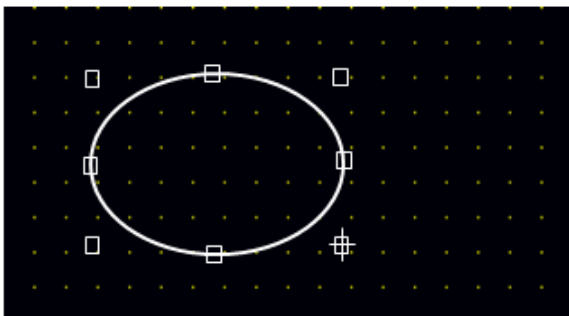

5th For changing color or style of circle, double-click the circle and 'Circle Property' dialog box appears. You can change the desired color and style of outline and designate inside pattern, foreground color, and background color.

5.4.2 Property

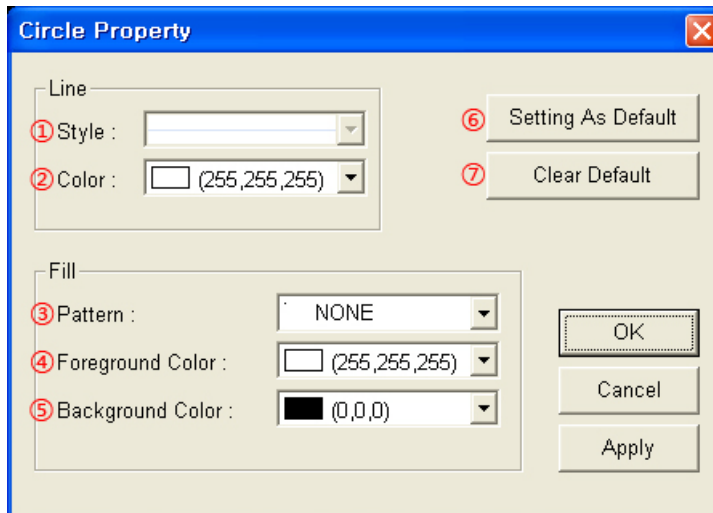

Item	Description
①Style	Not used
②Color	Designate outline color <ul style="list-style-type: none"> ▪ Mono type(GP-S044, GP-S057, LP-S044): White/Black ▪ Color type(GP-S070, LP-S070): 24bit True Color
③Pattern	Select one pattern of circle to fill inside by pull-down menu. Setting range is same with that of rectangle.
④Foreground Color	Designate foreground color <ul style="list-style-type: none"> ▪ Mono type(GP-S044, GP-S057, LP-S044): White/Black ▪ Color type(GP-S070, LP-S070): 24bit True Color
⑤Background Color	Designate background color <ul style="list-style-type: none"> ▪ Mono type(GP-S044, GP-S057, LP-S044): White/Black ▪ Color type(GP-S070, LP-S070): 24bit True Color
⑥Setting As Default	Draw next circle as currently designated settings
⑦Clear Default	Draw next circle as following ②Color: White, ③Pattern: None, ④Foreground Color: White, ⑤Background Color: Black

5.5 Text

Displays and arranges the user-defined text on screen.

5.5.1 Basic usage

1st Select [Draw]-[Text] of menu, or click  and 'Text' dialog box appears.

2nd Register the desired text at 'Text' dialog box, and designate text color, and font size, etc. (Color type supports using vector font.)

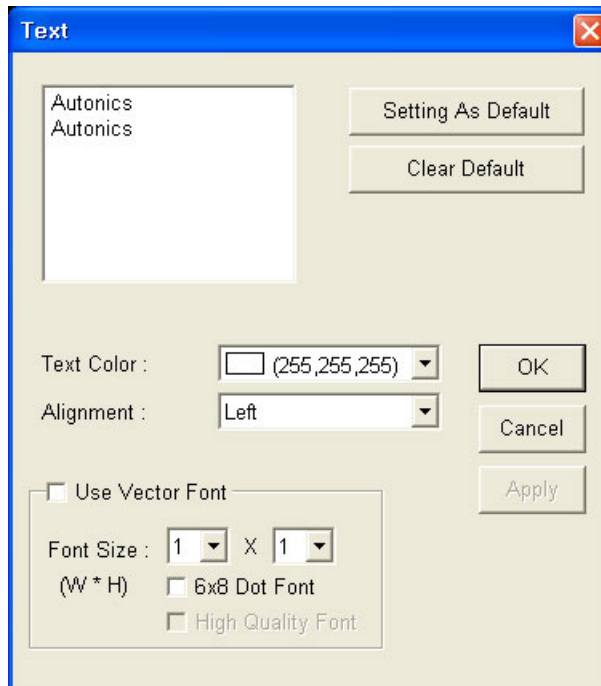

3rd Click 'OK' and 'Text' dialog box is closed. A dotted rectangle follows mouse cursor at edit area.

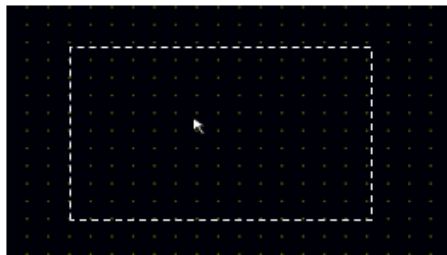

4th Place mouse cursor on the desired area, click left mouse button. Text is placed on the screen.

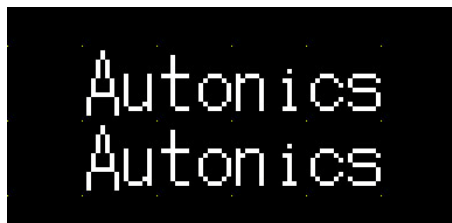

5.5.2 Property

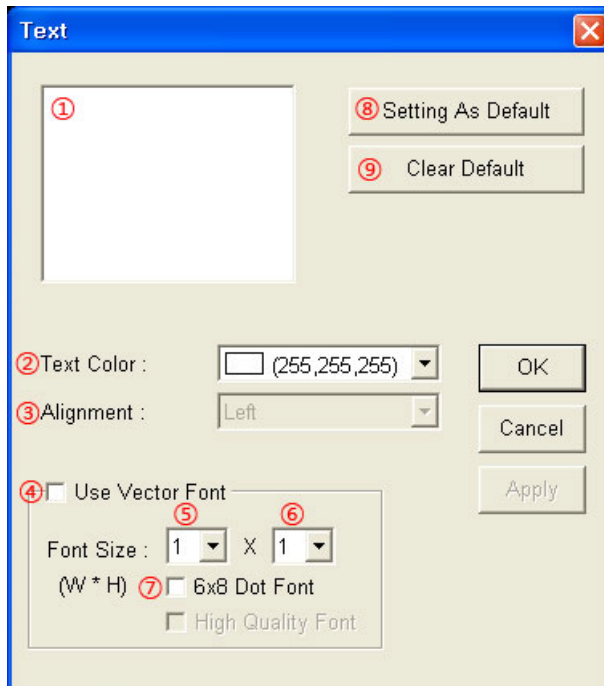

Item	Description
① Text	Edit text to display. If width or height text length are out of screen, or changed width or height font size is out of screen, 'Out Of Panel Size' message appears below this box. Adjust size or text length, and this message disappears.
② Text Color	Designates text color <ul style="list-style-type: none"> • Mono type(GP-S044, GP-S057, LP-S044): White/Black • Color type(GP-S070, LP-S070): 24bit True Color
③ Alignment	Activated only for more than two lines text from ① and designate alignment type by pull-down menu. <ul style="list-style-type: none"> • Left: Displays a letter from the left of tag area • Right: Displays a letter from the right of tag area • Center: Displays a letter in a center of tag area.
④ Use Vector Font	Activated only for color type (GP-S070, LP-S070). Non-checking this, it uses bitmap font. Checking this, it displays as following. <div style="text-align: center;"> </div> <p>① Font size, ② Bold font, ③ Italic font, ④ Underline, ⑤ Strikethrough</p>
⑤ Font Size (Width)	Designate width font size by pull-down menu. <ul style="list-style-type: none"> • Default =1, Range: 1, 2, 3, 4, 5, 6, 7, 8 • Height font size is 0.5, width font size 1 is only available.
⑥ Font Size (Height)	Designate height font size by pull-down menu. <ul style="list-style-type: none"> • Default =1, Range: 0.5, 1, 2, 3, 4, 5,6, 7, 8 • Width font sizes besides 1 are not available for height font size 0.5.

Item	Description
⑦ 6x8 Dot Font	Designate 6x8 dot font. Only ASCII font has 6x8 dot font. If there is not 6x8 dot font, it displays rectangles with the desired size and color.
⑧ Setting As Default	Draw next text as currently designated settings
⑨ Clear Default	Draw next text as following ② Text Color: White, ③ Alignment: Left, ⑤⑥ Font Size: 1x1



Note

Text font size

- 6X8, 8X8 dot ASCII font
- ASCII font and regional character with enlarged 8X16 dot font

8X8	8X16	8X32	8X48	8X64	8X72	8X80
16X8	16X16	16X32	16X48	16X64	16X72	16X80
---	24X16	24X32	24X48	24X64	24X72	24X80
---	32X16	32X32	32X48	32X64	32X72	32X80
---	40X16	40X32	40X48	40X64	40X72	40X80
---	48X16	48X32	48X48	48X64	48X72	48X80
---	56X16	56X32	56X48	56X64	56X72	56X80
---	64X16	64X32	64X48	64X64	64X72	64X80

5.6 Bitmap

Inserts bitmap image on screen. Depends on the number of selected image color and the designated number of image color from 'Project Auxiliary Property' dialog box, it is as following.

You can check the number of image color at [Common]-[Auxiliary Configuration]-[Project].

- Mono type(GP-S044, GP-S057, LP-S044)
If selected image is not mono, it converts the image by mono color and inserts it on screen.
- Color type(GP-S070, LP-S070)
 - If the number of selected image color has more than the designated number of image color, the selected image is converted by the designated number of image color and insert it on project.
 - If the number of selected image color less than or same with the designated number of image color, there are not converting and insert it on project directly.
- For using same images to others, it processes to use the image which is already registered and the basis for same image is image file name, and file size.
- To add the image which is already registered after changing the designated number of image color, regardless the designated number of image color, it uses the image as it is.

5.6.1 Basic usage

1st Select [Draw]-[Bitmap] of menu, or click  in toolbar, 'Graphic Library' dialog box appears.

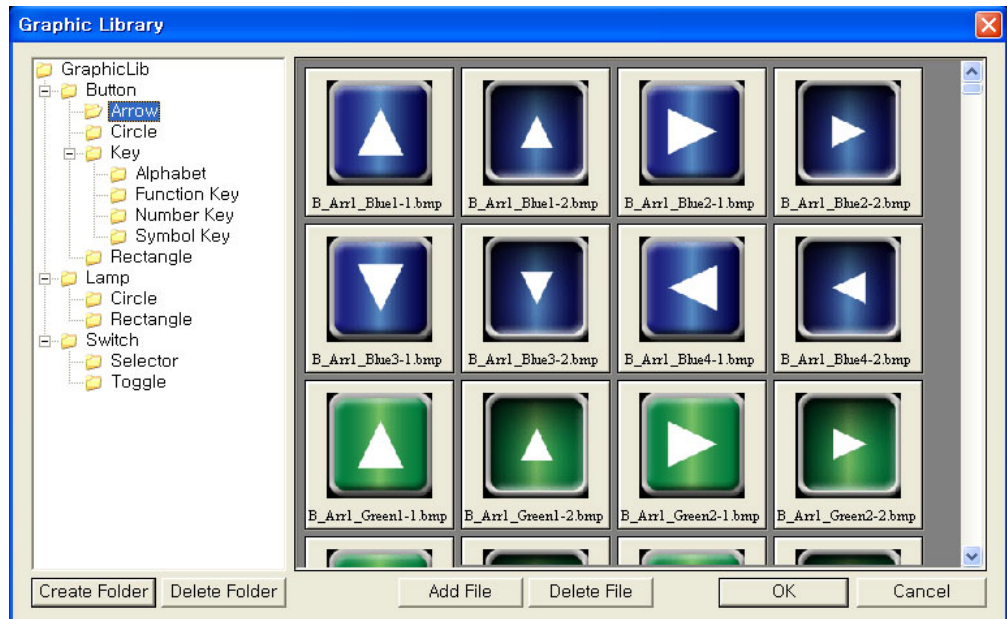

2nd Select the desired image and click 'OK' or double-click the desired image at preview, and 'Graphic Library' dialog box is closed. A dotted rectangle follows mouse cursor at edit area.

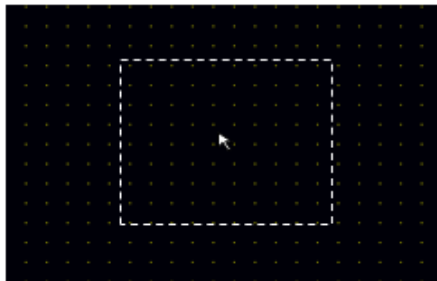

3rd Place mouse cursor on the desired area, click left mouse button. Bitmap image is placed on the screen.



5.6.2 Property



Graphic Library	Description
① Graphic Library	Displays data in GraphicLib folder as a tree
② Preview	Previews image file from selected folder by ①
③ Create Folder	Creates subfolder for selected folder by ①
④ Delete Folder	Deletes selected folder by ① (Deleted all images in this folder.)
⑤ Add File	Adds image file in selected folder by ①
⑥ Delete File	Deletes image file from selected image by ②
⑦ OK	Uses the selected image file by ②
⑧ Cancel	Closes 'Graphic Library' dialog box

5.7 Numeral Input

Numeral input tag is for inputting numeral to specified device by keywindow on screen or by user-defined key code of touch key.

If there is no input, it operates as numeral display. In other words, it displays numeral of specified device as designated form.



Ex.

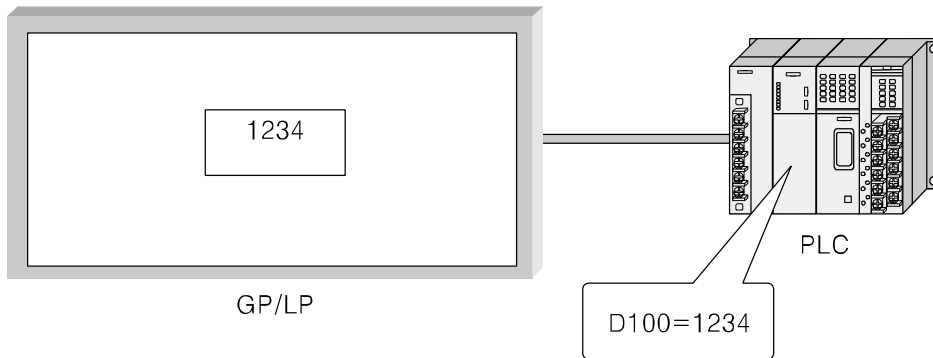

The above example is that numeral input device of PLC is D100, the designated numeral on GP/LP is 1234.

5.7.1 Basic usage

The following process is for registering numeral input tag.

- 1st Select [Draw]-[Numeral Input] of menu, or click  in toolbar, 'Numeral Input Property' dialog box appears.
- 2nd Designate device.
- 3rd Designate device data type.
- 4th Designate display type and digit, etc in 'Form' tab.
- 5th Click 'OK' and 'Numeral Input Property' dialog box is closed. A dotted rectangle follows mouse cursor at edit area.
- 6th Place mouse cursor on the desired area, click left mouse button. Numeral input is created on the screen.

5.7.2 Property

5.7.2.1 Basic tab

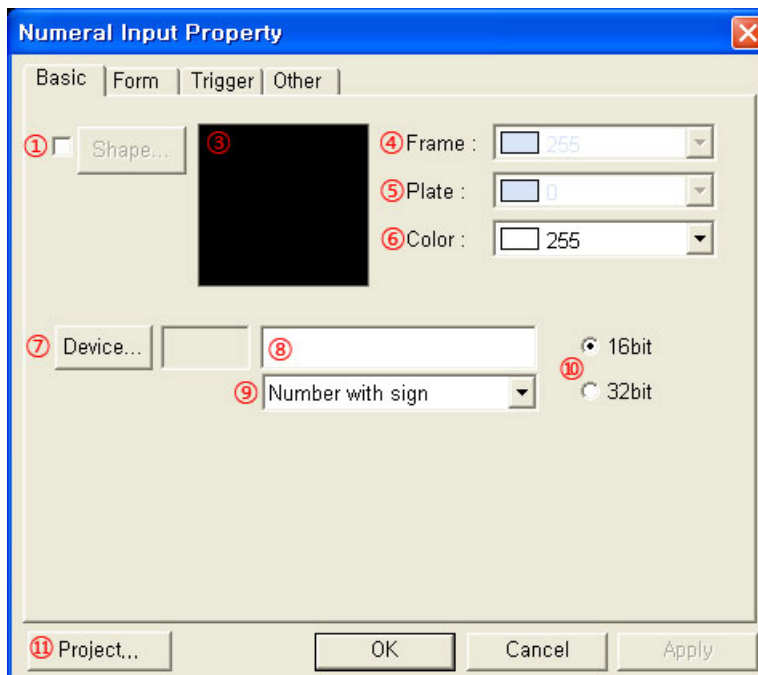

Basic	Description
① Shape	Designate using shape or not. Check this and no. 1 shape is as default.
② Shape	Activated only with checking ①. Click 'Shape' and 'Image Selection' dialog box appears. Select the desired shape.
③ Shape	Displays the selected shape image
④ Frame	Designates frame color. Activated only with checking ①. Mono type(GP-S044, GP-S057, LP-S044): White/Black Color type(GP-S070, LP-S070): 24bit True Color
⑤ Plate	Designates plate color. Activated only with checking ①. Mono type(GP-S044, GP-S057, LP-S044): White/Black Color type(GP-S070, LP-S070): 24bit True Color
⑥ Color	Designates text color. Mono type(GP-S044, GP-S057, LP-S044): White/Black Color type(GP-S070, LP-S070): 24bit True Color
⑦ Device	Calls 'Device Select' dialog box and designate word device.
⑧ Device	Input device directly or displays the designated device by ⑦
⑨ Data Type	Designate device type (Number with sign/Number without sign) by pull-down menu.
⑩ 16/32bit	Designate data size for input device Depending on connected device type, it may use only 32bit. Refer to 'GP,LP user manual for communication'.
⑪ Project	Calls 'Project Auxiliary Property' dialog box and select key window, or designate key window display type.

**Note**

[Input range by device type]

It enters integer with following range by data type.

- 16bit number with sign: -32768 to 32767
- 16bit number without sign: 0 to 65535
- 32bit number with sign: -2147483648 to 2147483647
- 32bit number without sign: 0 to 4294967295

5.7.2.2 Form tab

Form	Description
① Display Type	Designate one from decimal with sign, decimal without sign, hexadecimal, octal, binary or real number by pull-down menu. Real number is only available when data size is designated as 32bit in 'Basic' tab.
② Alignment	Designate alignment type (left, right, center) by pull-down menu. If text digit is less than the designated digit, alignment operates. <ul style="list-style-type: none"> ▪ Left: Displays a letter from the left of tag area ▪ Right: Displays a letter from the right of tag area ▪ Center: Displays a letter in a center of tag area
③ Digit	Designate digit number. Default is 6 and range is from 1 to 32.
④ Display All Digit	Displays all digit with 0 for blank when displayed number digit is less than ③ Digit. Activated only for ② Alignment as Right.
⑤ Decimal Point	Designate decimal point digit. If ① Display Type is decimal with/without sign, it displays decimal point at designated digit. It is not activated when ① Display Type is hexadecimal or octal.

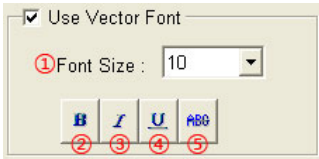
Form	Description
⑥ Use Vector Font	<p>Activated only for color type (GP-S070, LP-S070). Non-checking this, it uses bitmap font. Checking this, it displays as following.</p>  <p>① Font size, ② Bold font, ③ Italic font, ④ Underline, ⑤ Strikethrough</p>
⑦ Font Size (Width)	<p>Designate width font size by pull-down menu.</p> <ul style="list-style-type: none"> ▪ Default =1, Range: 1,2,4,6,8 ▪ Height font size is 0.5, width font size 1 is only available.
⑧ Font Size (Height)	<p>Designate height font size by pull-down menu</p> <ul style="list-style-type: none"> ▪ Default =1, Range: 0.5,1,2,3,4 ▪ Width font sizes besides 1 are not available for height font size 0.5.
⑨ 6x8 Dot Font	Designate 6x8 dot font
⑩ High Quality Font	Displays font with high quality. It is only available when ⑦,⑧ Font Size is 4X2 or more.

5.7.2.3 Trigger tab

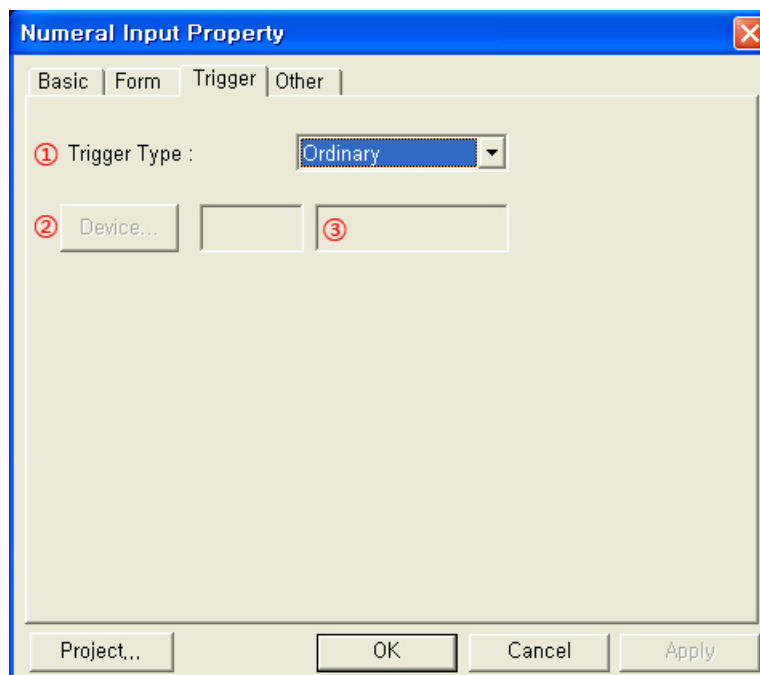

Trigger	Description
① Trigger Type	<p>Enables to input numeral when the designated bit device is trigger state. You can designate trigger function by pull-down menu.</p> <ul style="list-style-type: none"> ▪ Ordinary: Trigger function is not used. ▪ On: Use ON trigger. ▪ Off: Use OFF trigger.
② Device	Calls 'Device Select' dialog box and designate trigger device. It is not activated when ① Trigger Type is ordinary.
③ Device	Input device directly or displays the designated device by ②

 Note

[Project auxiliary property and numeral input trigger]

You can check project auxiliary property by [Common]-[Auxiliary Configuration]-[Project] of menu.

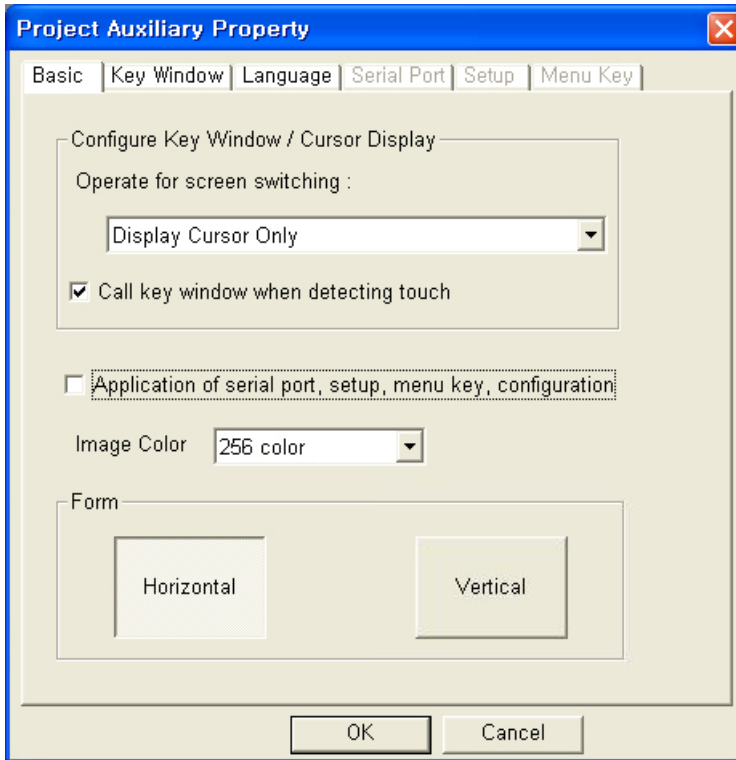

- Checking 'Call key window when detecting touch': It calls key window with touching tag input area and input is available when the trigger condition is satisfied. If the trigger condition is not satisfied when touching tag input area, buzzer sounds and key window is not called.
- Selecting 'Display Cursor And Key Window' at operate for screen switching: If there is not input tag which is satisfied trigger condition, key window is not called and input is not available.

5.7.2.4 Other tab

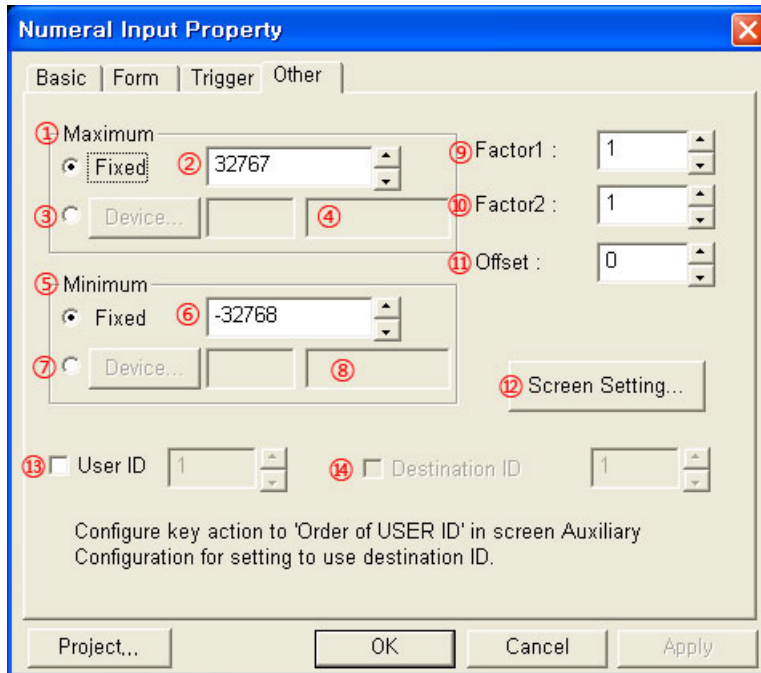

Other	Description
① to ④ Maximum	Designate maximum value to input <ul style="list-style-type: none"> Fixed: Uses the input value in ②.as maximum Device: Click 'Device' and 'Device Select' dialog box appears. Designate device or input it directly in ④. The device is used as maximum.
⑤ to ⑧ Minimum	Designate minimum value to input <ul style="list-style-type: none"> Fixed: Uses the input value in ⑥ as minimum. Device: Click 'Device' and 'Device Select' dialog box appears. Designate device or input it directly in ⑧. The device is used as minimum.
⑨Factor1	Defines applied operation the input value. For further details, refer to '5.7.2.5 Operation in numeral input'.
⑩Factor2	
⑪Offset	

Other	Description
⑫ Screen Setting	<p data-bbox="443 271 1410 360">Calls 'Screen Auxiliary Configuration' dialog box and set about input focus movement. Focus moves differently depending on selected key action by pull-down menu when completing numeral input at GP/LP.</p> <div data-bbox="448 365 932 815" style="border: 1px solid black; padding: 5px;"> <p data-bbox="453 371 927 398">Screen Auxiliary Configuration ✖</p> <p data-bbox="453 434 927 461">Cursor Movement</p> <p data-bbox="453 465 927 492">Key Action : Hide Cursor And Key Window ▼</p> <div data-bbox="603 497 927 539" style="border: 1px solid black; padding: 2px;"> <p data-bbox="603 497 927 524">No Movement</p> <p data-bbox="603 524 927 551">Order Of User ID</p> <p data-bbox="603 551 927 577">Hide Cursor And Key Window</p> </div> <p data-bbox="453 524 927 551">Other Configur</p> <p data-bbox="453 568 927 595"><input checked="" type="checkbox"/> Allow Floating Alarm</p> <p data-bbox="453 636 927 663">Background Color : (0,0,0) ▼</p> <p data-bbox="453 694 927 721">Security Level : 0 ▲▼</p> <p data-bbox="523 757 863 792" style="text-align: center;">OK Cancel</p> </div> <ul data-bbox="443 824 1410 958" style="list-style-type: none"> ▪ No Movement: Input focus does not move. ▪ Order of User ID: Input focus moves to input tag with using the designated ID on ⑭ as user ID. ▪ Hide Cursor And Key Window: Cursor and key window are disappeared.
⑬ User ID	Characteristic ID for divide numeral inputs on one screen. After inputting tag having this value as destination ID, input focus returns to this tag.
⑭ Destination ID	After inputting current tag, input focus moves to tag having this value as user ID.

5.7.2.5 Operation in numeral input

The following operation is when input value in key window is V_{in} , and input value at device is V_{dev} .

- Input value at device $V_{dev} = (V_{in} - \text{Offset}) \times \text{Factor2} / \text{Factor1}$
- Display value to numeral input tag = $(V_{dev} \times \text{Factor1}) / \text{Factor2} + \text{Offset}$

Division operation has quotient.



Ex.

- Factor1=10, Factor2=1, Offset=0, enter 12 in key window,
 - Input value at device = $(1 \times (12 - 0)) / 10 = 12 / 10 = 1$
 - Display value to tag = $(10 \times 1) / 1 + 0 = 10$
- Factor1=1, Factor2=10, Offset=0, enter 12 in key window,
 - Input value at device = $(10 \times (12 - 0)) / 1 = 120$
 - Display value to tag = $(1 \times 120) / 10 + 0 = 12$
- Factor1=1, Factor2=1, Offset=10, enter 12 in key window,
 - Input value at device = $(1 \times (12 - 10)) / 1 = 2$
 - Display value to tag = $(1 \times 2) / 1 + 10 = 12$
- Factor1=10, Factor2=1, Offset=5, enter 12 in key window,
 - Input value at device = $(1 \times (12 - 5)) / 10 = 7 / 10 = 0$
 - Display value to tag = $(10 \times 0) / 1 + 5 = 5$

5.7.3 Change numeral

Changing numeral is only available at GP/ LP.

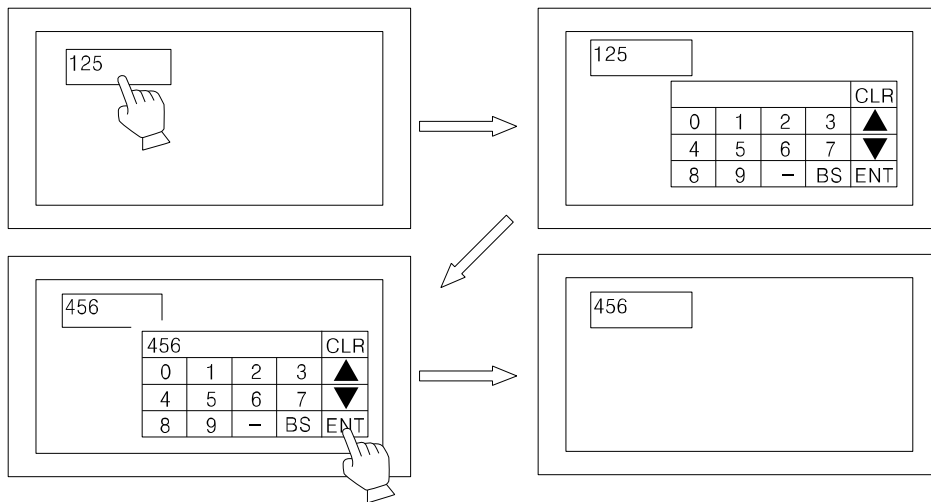

1st Touch screen area which has numeral input tag.

2nd Key window for numeral input appears.

3rd Enter numeral with key window and touch ENT.

4th Key window disappears and input numeral is displayed at numeral input tag.



Note

Calling condition for cursor and key window is designated by configure key window/cursor display group box of 'Basic' tab from 'Project Auxiliary Property' dialog box. Movement of input focus is designated by cursor movement box of 'Screen Auxiliary Configuration' dialog box.

5.8 ASCII Input

ASCII input tag is for inputting character strings to PLC device by key window on screen.

If there is no input, it operates as ASCII display. In other words, it displays character strings of PLC device as relevant form.



Ex.

Device value is as below table when ASCII input tag device is D100, ASCII input tag displays 'ABCD'.

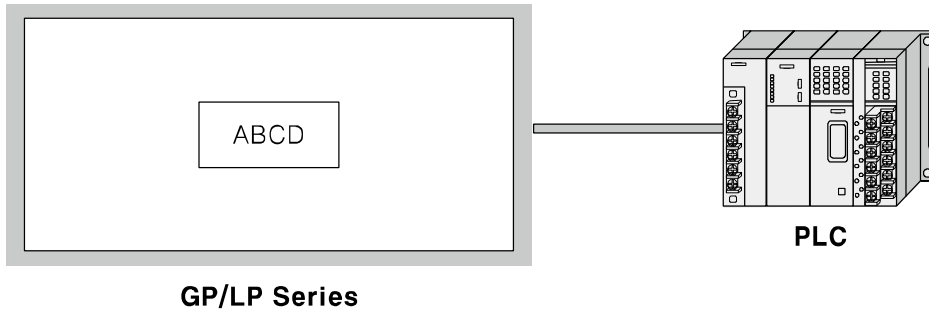

Device	D100 (Lower)	D100 (Upper)	D101 (Lower)	D101 (Upper)	D102 (Upper)
ASCII	41H	42H	43H	44H	0H
Character	'A'	'B'	'C'	'D'	Completes character

D102(Upper)=0H is for completing character when inputting ABCD with key window at ASCII input tag, and touching ENT.

5.8.1 Basic usage

- 1st Select [Draw]-[ASCII Input] of menu, or click  in toolbar, 'ASCII Input Property' dialog box appears.
- 2nd Designate device.
- 3rd Designate digit in 'Form' tab.
- 4th Click 'OK' and 'ASCII Input Property' dialog box is closed. A dotted rectangle follows mouse cursor at edit area.
- 5th Place mouse cursor on the desired area, click left mouse button. ASCII input tag is created on the screen.

5.8.2 Property

5.8.2.1 Basic tab

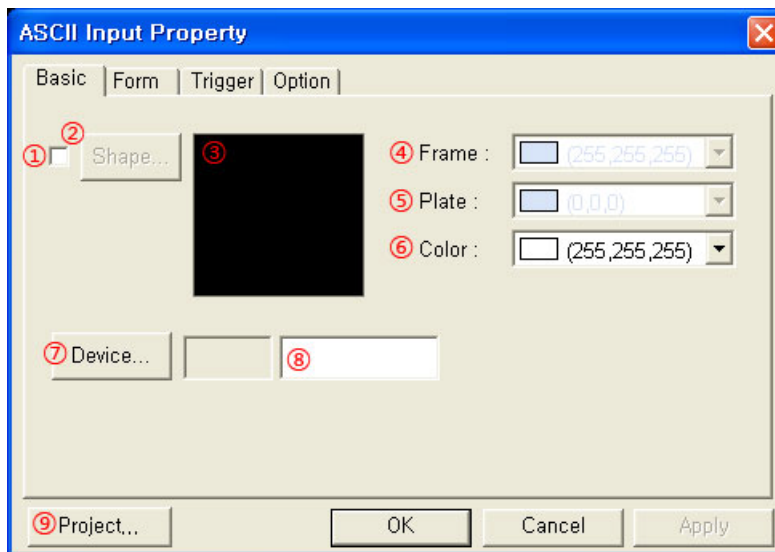

Basic	Description
①Shape	Designate using shape or not. Check this and no. 1 shape is as default.
②Shape	Activated only with checking ①. Click 'Shape' and 'Image Selection' dialog box appears. Select the desired shape.
③Shape	Displays the selected shape image.
④Frame	Designates frame color. Activated only with checking ①. <ul style="list-style-type: none"> • Mono type(GP-S044, GP-S057, LP-S044): White/Black • Color type(GP-S070, LP-S070): 24bit True Color
⑤Plate	Designates plate color. Activated only with checking ①. <ul style="list-style-type: none"> • Mono type(GP-S044, GP-S057, LP-S044): White/Black • Color type(GP-S070, LP-S070): 24bit True Color
⑥Text	Designates text color. <ul style="list-style-type: none"> • Mono type(GP-S044, GP-S057, LP-S044): White/Black • Color type(GP-S070, LP-S070): 24bit True Color
⑦Device	Calls 'Device Select' dialog box and designate monitor device.
⑧Device	Input device directly or displays the designated device by ⑦.
⑨Project	Calls 'Project Auxiliary Property' dialog box and designate about key window.

5.8.2.2 Form tab

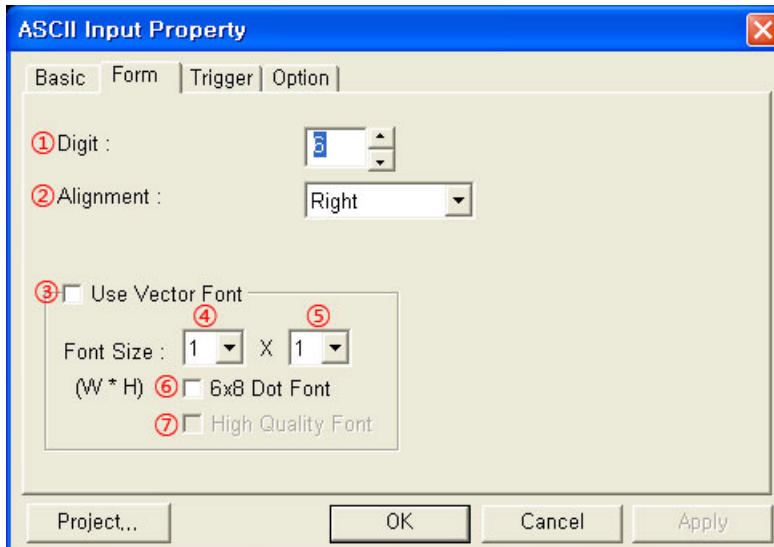

Form	Description
①Digit	Designate character digit number to display. Default is 6 and range is from 2 to 40 by even number.
②Alignment	Designate alignment type (left, right, center) by pull-down menu. If text digit is less than the designated digit, alignment operates. <ul style="list-style-type: none"> Left: Displays a letter from the left of tag area. Right: Displays a letter from the right of tag area. Center: Displays a letter in a center of tag area.
③Use Vector Font	Activated only for color type (GP-S070, LP-S070). Non-checking this, it uses bitmap font. Checking this, it displays as following. <div style="text-align: center;"> </div> <p>①Font size, ②Bold font, ③Italic font, ④Underline, ⑤Strikethrough</p>
④Font Size(Width)	Designate width font size by pull-down menu. <ul style="list-style-type: none"> Default =1, Range: 1,2,4,6,8 Height font size is 0.5, width font size 1 is only available.
⑤Font Size(Height)	Designate height font size by pull-down menu <ul style="list-style-type: none"> Default =1, Range: 0.5,1,2,3,4 Width font sizes besides 1 are not available for height font size 0.5.
⑥6x8 Dot Font	Designate 6x8 dot font. Only ASCII font has 6x8 dot font. If there is not 6x8 dot font, it displays rectangles with the desired size and color.
⑦High Quality Font	Not used

5.8.2.3 Trigger tab

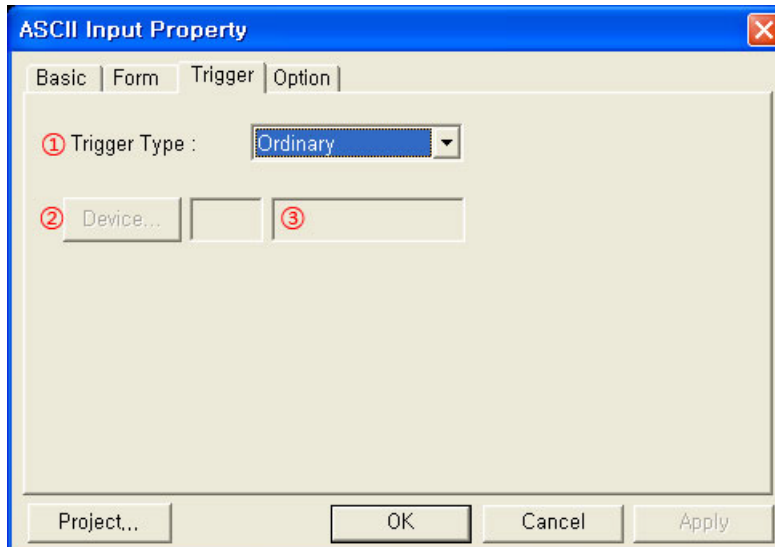

Trigger	Description
① Trigger Type	Enables to input numeral when the designated bit device is trigger state. You can designate trigger function by pull-down menu. <ul style="list-style-type: none"> • Ordinary: Trigger function is not used. • On: Use ON trigger. • Off: Use OFF trigger.
② Device	Calls 'Device Select' dialog box and designate trigger device. It is not activated when ① Trigger Type is ordinary.
③ Device	Input device directly or displays the designated device by ②

 Note

[Project auxiliary property and ASCII input trigger]

You can check project auxiliary property by [Common]-[Auxiliary Configuration]-[Project] of menu.

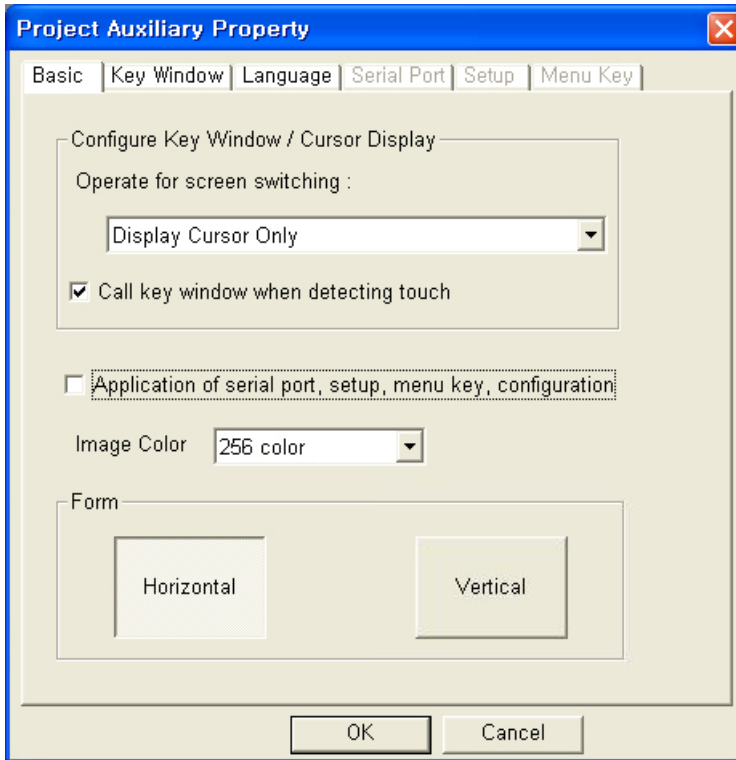

- Checking 'Call key window when detecting touch': It calls key window with touching tag input area and input is available when the trigger condition is satisfied. If the trigger condition is not satisfied when touching tag input area, buzzer sounds and key window is not called.
- Selecting 'Display Cursor And Key Window' at operate for screen switching: If there are not input tag which is satisfied trigger condition, key window is not called and input is not available.

5.8.2.4 Option tab

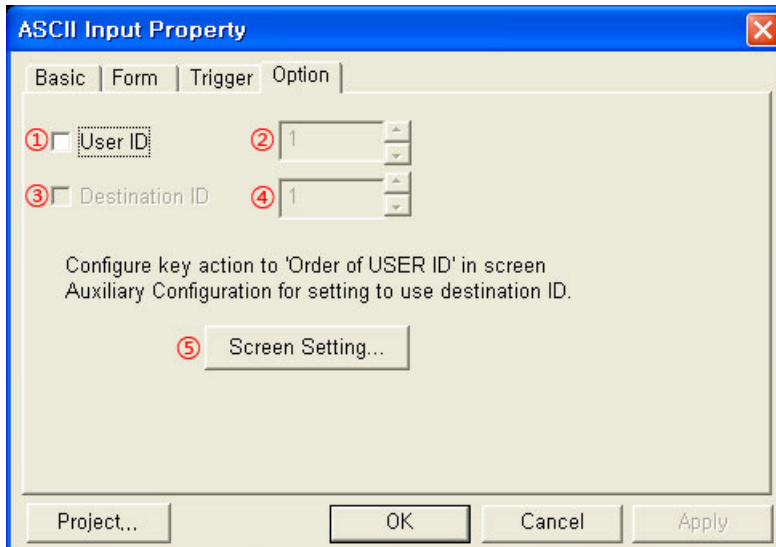

Option	Description
①User ID	Designate to use user ID or not.
②User ID	Designate user ID. Range is from 1 to 50.
③Destination ID	Designate to use destination ID or not. It is activated only when key action is as order of user ID of 'Screen Auxiliary Configuration' dialog box.
④Destination ID	Designate destination ID.
⑤Screen Setting	<p>Calls 'Screen Auxiliary Configuration' dialog box and set about input focus movement. Focus moves differently depending on selected key action by pull-down menu when completing numeral input at GP/LP.</p> <ul style="list-style-type: none"> • No Movement: Input focus does not move. • Order of User ID: Input focus moves to input tag with using the designated ID on ④ as user ID. • Hide Cursor And Key Window: Cursor and key window are disappeared.

5.8.3 Change ASCII

Changing ASCII is only available at GP/ LP.

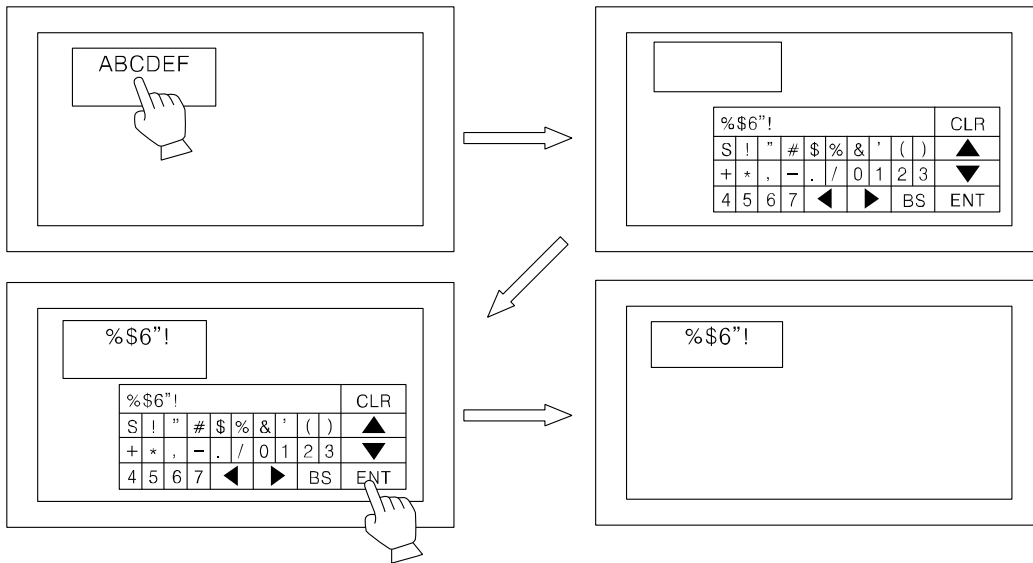

1st Touch screen area which has ASCII input tag.

2nd Key window for ASCII input appears.

3rd Enter character with key window and touch ENT.

4th Key window disappears and input character is displayed at ASCII input tag.



Note

- Calling condition for cursor and key window is designated by configure key window/cursor display group box of 'Basic' tab from 'Project Auxiliary Property' dialog box. Movement of input focus is designated by cursor movement box of 'Screen Auxiliary Configuration' dialog box.
- Displayed character on screen has code for value on specified device.
- From specified device, two digits of word device are displayed.
- At the same word devices, if lower/upper bytes are each of half-width character (1byte) code, lower byte is displayed at first.



Ex.

If device is D100, digit is 6, the related character which is the order of D100(Lower), D100(Upper), D101(Lower), D101(Upper), D102(Lower), D102(Upper) are displayed. If there is 0 in the middle, the following character is not displayed.



Ex.

D100(Lower)=41H='A', D100(Upper)=42H='B', D101(Lower)=43H='C', D101(Upper)=00H='\0', D102(Lower)=44H='E', D102(Upper)=45H='F', it displays ABC.

- With designated 6X8 dot font, 2 byte character is displayed as rectangle with designated font color.
- If there are not related character on device or it is not able to display (control character), it displays as rectangle.

- At GP/LP inputting, first input character code is saved in order of lower to upper at lead address.
- At GP/LP inputting, if input character digit is not proper the designated digit and inputting ENT, the following saved space is filled with 0.



Ex.

Device =D100, Digit =6, with inputting A, B, C, and ENT;
D100 = 4241H, D101=0043H, D102=0000H

5.9 Numeral Display

Numeral display is for displaying value on specified device as designated numeral type.

It displays user-defined PLC device value as designated numeral type.



Ex.

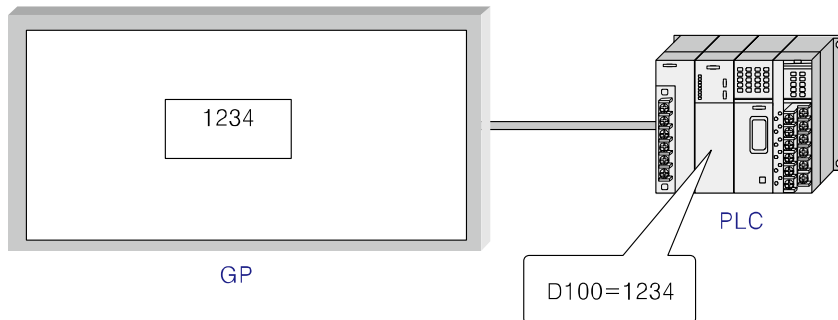

The above example is that device is D100, display form is decimal, saved value is 1234.

5.9.1 Basic usage

- 1st Select [Draw]-[Numeral Display] of menu, or click  in toolbar, 'Numeral Display Property' dialog box appears.
- 2nd Designate device.
- 3rd Designate device data type. (number with sign/number without sign, 16/32bit)
- 4th Designate display type and digit, etc in 'Form' tab.
- 5th Designate operation in 'Operation' tab.
- 6th Click 'OK' and 'Numeral Display Property' dialog box is closed. A dotted rectangle follows mouse cursor at edit area.
- 7th Place mouse cursor on the desired area, click left mouse button. Numeral display is created on the screen.

5.9.2 Property

5.9.2.1 Basic tab

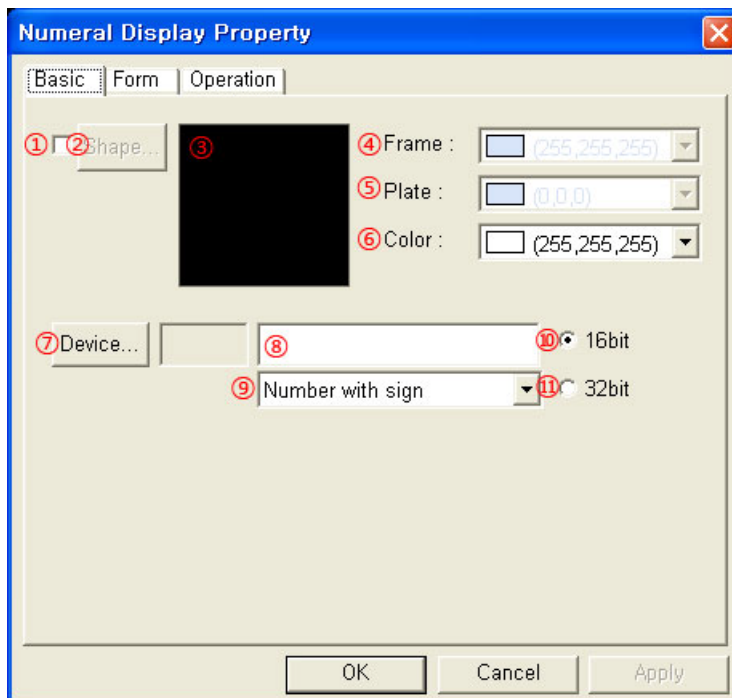

Basic	Description
① Shape	Designate using shape or not. Check this and no. 1 shape is as default.
② Shape	Activated only with checking ①. Click 'Shape' and 'Image Selection' dialog box appears. Select the desired shape.
③ Shape	Displays the selected shape image
④ Frame	Designates frame color. Activated only with checking ①. <ul style="list-style-type: none"> • Mono type(GP-S044, GP-S057, LP-S044): White/Black • Color type(GP-S070, LP-S070): 24bit True Color
⑤ Plate	Designates plate color. Activated only with checking ①. <ul style="list-style-type: none"> • Mono type(GP-S044, GP-S057, LP-S044): White/Black • Color type(GP-S070, LP-S070): 24bit True Color
⑥ Color	Designates text color. <ul style="list-style-type: none"> • Mono type(GP-S044, GP-S057, LP-S044): White/Black • Color type(GP-S070, LP-S070): 24bit True Color
⑦ Device	Calls 'Device Select' dialog box and designate monitor device.
⑧ Device	Input device directly or displays the designated device by ⑦
⑨ Data Type	Designate device type by pull-down menu. <ul style="list-style-type: none"> • Number with sign: Processes number with sign reading data • Number without sign: Processes number without sign reading data
⑩ 16 bit	Select this when monitor device is 16 bit word device

Basic	Description
① 32bit	Select this when monitor device is 32bit word device. Depending on connected device type, it may use only 32bit. Refer to 'GP,LP user manual for communication'.
Shape	Designates for frame and plate color is available only with checking ① <ul style="list-style-type: none">▪ Default: Frame=White, Background color=Black, Font color=White▪ Not using shape with non-checking ① displays tag as transparently and behind object is also displayed. Using shape with checking ① fills plate inside with designated color and the tag is opaque.

5.9.2.2 Form tab

Form	Description
① Display Type	<p>Designate numeral display form by pull-down menu.</p> <ul style="list-style-type: none"> Decimal with sign: Displays number with sign as decimal Decimal without sign: Displays number without sign as decimal Hexadecimal: Displays as hexadecimal Octal: Displays as octal Binary: Displays as binary Real number: Displays as real number processing IEEE floating decimal point number. Real number is only available when data size is designated as 32bit in 'basic' tab. <p>For further details, refer to '5.9.3 Display type and operation'.</p>
② Alignment	<p>Designate alignment type (left, right, center) by pull-down menu. If text digit is less than the designated digit, alignment operates.</p> <ul style="list-style-type: none"> Left: Displays a letter from the left of tag area. Right: Displays a letter from the right of tag area. Center: Displays a letter in a center of tag area.
③ Digit	<p>Designate digit number. When the number (including - . E) is not displayed as designated type, it is displayed as HHHH... or LLLL....</p>
④ Display All Digit	<p>Displays all digit with 0 for blank when displayed number digit is less than ③ Digit. Activated only for ② Alignment as Right.</p>
⑤ Decimal Point	<p>Designate decimal point digit. If ① Display Type is decimal with/without sign, it displays decimal point at designated digit. It is not activated when ① Display Type is hexadecimal or octal. For further details of real number, refer to '5.9.3.4 Real number display of GP/LP'.</p>

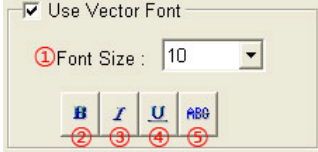
Form	Description
⑥ Use Vector Font	<p>Activated only for color type (GP-S070, LP-S070). Non-checking this, it uses bitmap font. Checking this, it displays as following.</p>  <p>① Font size, ② Bold font, ③ Italic font, ④ Underline, ⑤ Strikethrough</p>
⑦ Font Size (Width)	<p>Designate width font size by pull-down menu.</p> <ul style="list-style-type: none"> ▪ Default =1, Range: 1,2,4,6,8 ▪ Height font size is 0.5, width font size 1 is only available.
⑧ Font Size (Height)	<p>Designate height font size by pull-down menu</p> <ul style="list-style-type: none"> ▪ Range: 0.5, 1, 2, 3, 4 ▪ Width font sizes besides 1 are not available for height font size 0.5.
⑨ 6x8 Dot Font	Designate 6x8 dot font
⑩ High Quality Font	Displays font with high quality. It is only available when ⑦,⑧ Font Size is 4X2 or more.

5.9.2.3 Operation tab

Operation tab is not activated when display type is real number. Operation executes in order multiplication, division, and addition.

Device value= V, Display value = (Factor1 x V) /Factor2 + Offset

The range is depending on the designated device type in 'Basic' tab and the designated display type in 'Form' tab.

Operation	Description
①Factor 1	Multiplies device value by factor 1.
②Factor 2	Divides device value by factor 2.
③Offset	Adds device value to offset.

5.9.3 Display type and operation

5.9.3.1 Numeral display range by data type (Unapplied operation)

Data Type	Minimum	Maximum
Decimal with sign 16bit	-32,768	32,767
Decimal without sign 16bit	0	65,535
Decimal with sign 32bit	-2,147,483,648	2,147,483,647
Decimal without sign 32bit	0	4,294,967,295

5.9.3.2 Numeral display process

As following process is for when display type is real number.

- 1st Saves the processed value as the designated data type reading by serial communication at 32bit memory. Even though the designated device is 16bit in 'Basic' device, it saves at 32bit memory of GP/LP.
- 2nd Executes operation by the designated factor1, factor2, and offset in 'Operation' tab.
- 3rd Displays the designated type on screen.



Note

- At 1st process, if the device of controller (PLC) is 32bit with sign/without sign, the value which is saved at device is saved as it is at 32bit memory of GP/LP.

If the device of controller (PLC) is 16bit with sign/without sign and positive number, the value which is saved device is saved as it is at lower word for 32bit memory of GP/LP.

Be note that when it is 16bit with sign and negative number. For example, if the saved value which is processed as number with sign on 16 bit memory of controller is same as negative number -1, the saved value of controller is two's complement of -1 as $2^{16}-1=65535$. When this value is saved at 32bit GP/LP memory, this is two's complement for -1 about 32bit as $2^{32}-1=4,294,967,295$.

- Display value is different depending on display type as decimal with sign or decimal without sign. The operated value which is decimal with sign, it processes 32bit number with sign, or the operated value which is decimal without sign, it processes 32bit number without sign.

The following figure is that saved value -1 in 16bit memory of controller is saved 32bit GP/LP memory in accordance with designation of 16bit with/without sign and displayed screen in accordance with designation of display type as with/without sign.

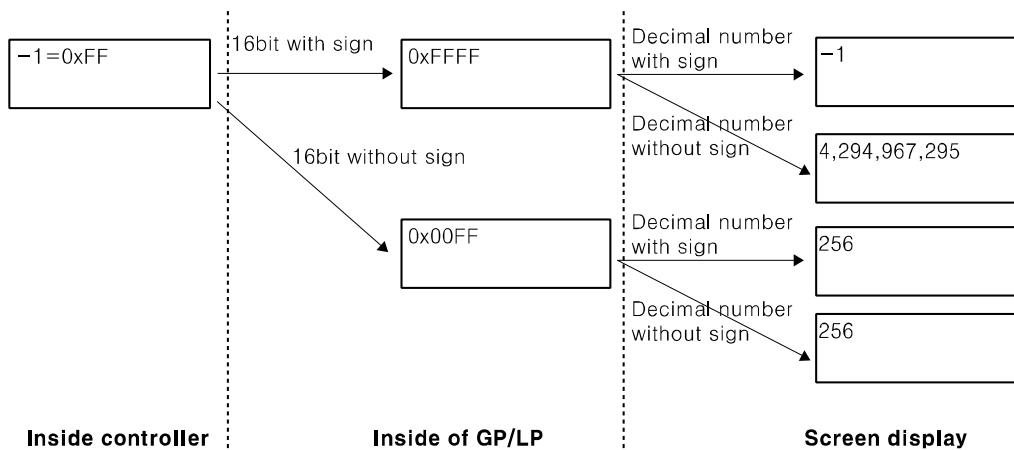

5.9.3.3 32bit floating decimal point type(IEEE Standard 754)

Upper 16bits																Lower 16bits																				
S	E7	E6	E5	E4	E3	E2	E1	E0	A22	A21	A20	A19	A18	A17	A16	A15	A14	A13	A12	A11	A10	A9	A8	A7	A6	A5	A4	A3	A2	A1	A0					
B31	B30	B29	B28	B27	B26	B25	B24	B23	B22	B21	B20	B19	B18	B17	B16	B15	B14	B13	B12	B11	B10	B9	B8	B7	B6	B5	B4	B3	B2	B1	B0					
sign bit	Exponent								Mantissa																											

- Sign bit: B31; '1' is negative number, '0' is 0 or positive number.
- 8bit exponent: B23 to B30 or E0 to E7
- 23bit mantissa: B0 to B22 or A0 to A22
- Displayed number

$$x = (-1)^{A_{31}} \times (2^0 + A_{22}2^{-1} + A_{21}2^{-2} + A_{20}2^{-3} + \dots + A_02^{-23}) \times 2^{(E_72^7 + E_62^6 + E_52^5 + \dots + E_02^0 - 127)}$$
- Display range
 - Maximum display absolute number: $2^{127}(2 - 2^{-23}) \approx 3.40282346 \times 10^{+38}$
 - Minimum display absolute number: $2^{-126} \approx 1.175494351 \times 10^{-38}$
 - Displayed number range: $-3.402823466 \times 10^{+38} \sim +3.402823466 \times 10^{+38}$
- If exponent is 0 or 255, it is reserved for an exceptional condition and the above formula is not applied to this case.

5.9.3.4 Real number display of GP/LP

Real number display has complex processes but also has flexible mark.

The general rules are as below.

- ① Positive number does not display '+' sign.
- ② Exponent part does not display '+' sign.
- ③ Round off the next of last displayed digit.

The follow examples is that if display number is real number with exponent (e), depending on the designated display digit, and decimal point digit.



Ex.

- **Case 1.** Absolute value of display number is bigger than 1. (e>=0)
It displays with fixed decimal point if the designated digit displays with fixed decimal point type.
If not, it displays with floating decimal point.
 - Ex 1) Real number=1234.567
 - (a) Digit= 10, Decimal point digit= 2 ; Displayed number= 1234.56
 - (b) Digit= 10, Decimal point digit= 6 ; Displayed number= 1234.56700
 - Ex 2) Real number=12.34567
It displays with fixed decimal point type if the designated digit displays all positive numbers without respecting accuracy.
 - (a) Digit= 6, Decimal point digit= 4 ; Displayed number= 12.345
 - (b) Digit= 4, Decimal point digit= 2 ; Displayed number= 12.3

- Ex 3) It displays with floating decimal point if the designated digit does not display some of positive numbers.

Real number = 1234567.0 = 1.234567e+6

(a) Digit= 6, Decimal point digit= 2 ; Displayed number= 1.23E6

(b) Digit= 5, Decimal point digit= 2 ; Displayed number= 1.2E6

- Ex 4) Real number= 1234567.0 = 1.234567e + 6

(a) Digit= 6, Decimal point digit= 2 ; Displayed number= 1.23E6

(b) Digit= 5, Decimal point digit= 2 ; Displayed number= 1.2E6

- Ex 5) Real number= 1.234567X10⁺¹⁵

Digit= 3, Decimal point digit= 1 ; Displayed number= E15 ; Skips '+' sign

- Ex 6) Real number= -1.234567 X 10⁺¹⁵

(a) Digit= 4, Decimal point digit= 2 ; Displayed number= -E15 ; Displays '-' sign

- Ex 7) Real number=1.234567e+15; If sign or exponent is not displayed, positive number displays 'H' as many as that digit.

Digit=2, Decimal point digit=0 ; Displayed= HH

- Ex 8) Real number=-1.234567e+15 ; ; If sign or exponent is not displayed, negative number displays 'L' as many as that digit.

Digit=3, Decimal point digit=2 ; Displayed= LLL

- **Case 2.** Absolute value of display number is smaller than 1. ($e < 0$)

It displays with fixed decimal point if absolute value is bigger than 1/1000. ($e \geq -2$)

- Ex 9) Real number= 0.1234567

(a) Digit= 10, Decimal point digit= 8 ; Displayed number= 0.12345670

(b) Digit= 10, Decimal point digit= 5 ; Displayed number= 0.12345

- Ex 10) Real number= 0.01234567

(a) Digit= 10, Decimal point digit= 8 ; Displayed number= 0.01234567

(b) Digit= 10, Decimal point digit= 5 ; Displayed number= 0.01234

It displays with floating decimal point if absolute value is smaller than 1/1000. ($e < -2$)

(Digit $\leq e + 1$)

- Ex 11) Real number= 0.001234567

(a) Digit= 10 ; Displayed number= 1.23456E-3

(b) Digit= 6 ; Displayed number= 1.2E-3

(c) Digit= 3 ; Displayed number= E-3

- Ex 12) Real number= -1.234567X10⁻¹⁵

(a) Digit= 8 ; Displayed number= -1.2E - 15

(b) Digit= 5 ; Displayed number= -E - 15

If sign or exponent is not displayed with floating decimal point type, it displays '0' as many as that digit.

- Ex 13) Real number= 0.001234567
Digit=2 ; Displayed number= 00
- Ex 14) Real number= $-1.234567 \times 10^{-15}$
Digit= 4 ; Displayed number= 000

5.10 ASCII Display

ASCII display is for displaying the value of word device as specified character. It is same with ASCII input tag without input feature.

It displays character strings of PLC device as relevant form.



Ex.

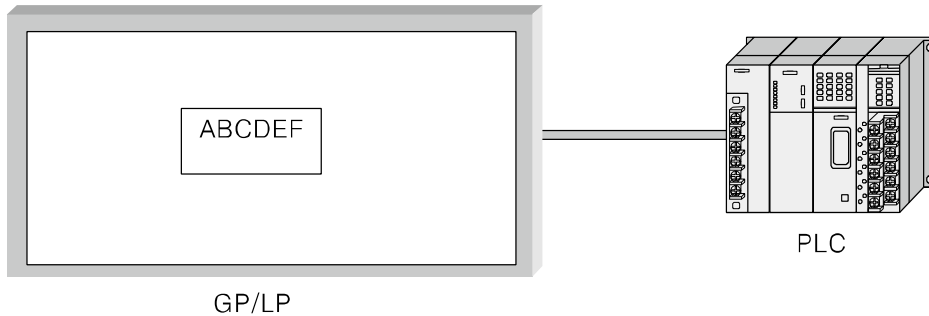

The below table is for PLC device value when ASCII display tag device is D100, and ASCII input tag is 'ABCDEF'.

Device	D100 (Lower)	D100 (Upper)	D101 (Lower)	D101 (Upper)	D102 (Lower)	D102 (Upper)
Value	41H	42H	43H	44H	45H	46H
Character	'A'	'B'	'C'	'D'	'E'	'F'

5.10.1 Basic usage

- 1st Select [Draw]-[ASCII Display] of menu, or click  in toolbar, 'ASCII Display Property' dialog box appears.
- 2nd Designate device.
- 3rd Designate digit in 'Form' tab.
- 4th Click 'OK' and 'ASCII Display Property' dialog box is closed. A dotted rectangle follows mouse cursor at edit area.
- 5th Place mouse cursor on the desired area, click left mouse button. ASCII display tag is created on the screen.

5.10.2 Property

5.10.2.1 Basic tab

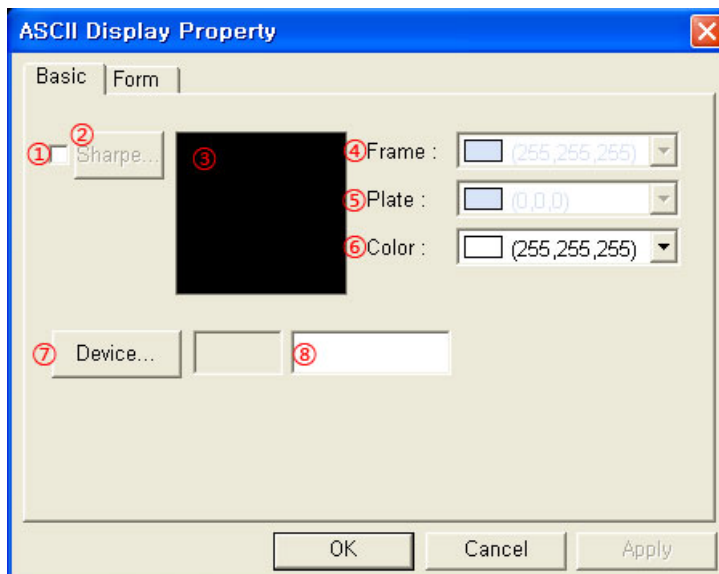

Basic	Description
①Shape	Designate using shape or not. Check this and no. 1 shape is as default.
②Shape	Activated only with checking ①. Click 'Shape' and 'Image Selection' dialog box appears. Select the desired shape.
③Shape	Displays the selected shape image
④Frame	Designates frame color. Activated only with checking ①. <ul style="list-style-type: none"> • Mono type(GP-S044, GP-S057, LP-S044): White/Black • Color type(GP-S070, LP-S070): 24bit True Color
⑤Plate	Designates plate color. Activated only with checking ①. <ul style="list-style-type: none"> • Mono type(GP-S044, GP-S057, LP-S044): White/Black • Color type(GP-S070, LP-S070): 24bit True Color
⑥Text	Designates text color. <ul style="list-style-type: none"> • Mono type(GP-S044, GP-S057, LP-S044): White/Black • Color type(GP-S070, LP-S070): 24bit True Color
⑦Device	Calls 'Device Select' dialog box and designate monitor device.
⑧Device	Input device directly or displays the designated device by ⑦

5.10.2.2 Form tab

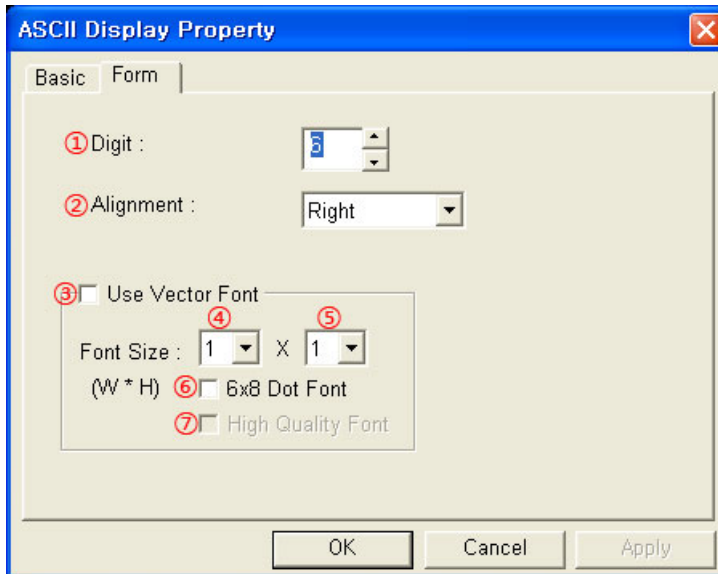

Form	Description
①Digit	Designate character digit number to display. Range is from 2 to 40 by even number.
②Alignment	Designate alignment type (left, right, center) by pull-down menu. If text digit is less than the designated digit, alignment operates. <ul style="list-style-type: none"> Left: Displays a letter from the left of tag area. Right: Displays a letter from the right of tag area. Center: Displays a letter in a center of tag area.
③Use Vector Font	Activated only for color type (GP-S070, LP-S070). Non-checking this, it uses bitmap font. Checking this, it displays as following. <div style="text-align: center;"> </div> ①Font size, ②Bold font, ③Italic font, ④Underline, ⑤Strikethrough
④Font Size (Width)	Designate width font size by pull-down menu. Range: 1, 2, 4, 6, 8 <ul style="list-style-type: none"> Height font size is 0.5, width font size 1 is only available.
⑤Font Size (Height)	Designate height font size by pull-down menu <ul style="list-style-type: none"> Range: 0.5, 1, 2, 3, 4 Width font sizes besides 1 are not available for height font size 0.5.
⑥6x8 Dot Font	Designate 6x8 dot font. Only ASCII font has 6x8 dot font. If there is not 6x8 dot font, it displays rectangles with the desired size and color.
⑦High Quality Font	Not used

**Note**

- Displayed character on screen has code for value on specified device.
- From specified device, two digits of word device are displayed.
- String which has low address device is displayed at first (at left direction).
- At the same word devices, if lower/upper bytes are each of half-width character (1byte) code, lower byte is displayed at first.

**Ex.**

If device is D100, digit is 6, the related character which is the order of D100(Lower), D100(Upper), D101(Lower), D101(Upper), D102(Lower), D102(Upper) are displayed. If there is 0 in the middle, the following character is not displayed.

**Ex.**

D100(Lower)=41H='A', D100(Upper) =42H='B', D101(Lower) =43H='C',

D101(Upper) =00H='\0', D102(Lower) =44H='E', D102(Upper) =45H='F', it displays ABC.

With designated 6X8 dot font, 2 byte character is displayed as rectangle with designated font color.

If there are not related character on device or it is not able to display (control character), it displays as rectangle.

5.11 Clock

Displays time or date by clock of inner GP/LP regardless of controller (PLC) connected GP/LP.

5.11.1 Basic usage

- 1st Select [Draw]-[Clock] of menu, or click  in toolbar, 'Clock Property' dialog box appears.
- 2nd Select display type(date or time) in 'Basic' tab.
- 3rd Click 'OK' and 'Clock Property' dialog box is closed. A dotted rectangle follows mouse cursor at edit area.
- 4th Place mouse cursor on the desired area, click left mouse button. Clock is placed on the screen.

5.11.2 Property

5.11.2.1 Basic tab

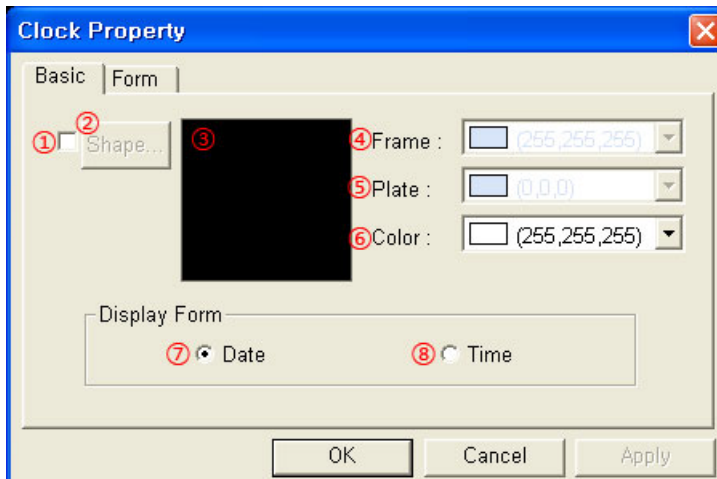

Basic	Description
① Shape	Designate using shape or not. Check this and no. 1 shape is as default.
② Shape	Activated only with checking ①. Click 'Shape' and 'Image Selection' dialog box appears. Select the desired shape.
③ Shape	Displays the selected shape image
④ Frame	Designate frame color. Activated only with checking ①. <ul style="list-style-type: none"> ▪ Mono type(GP-S044, GP-S057, LP-S044): White/Black ▪ Color type(GP-S070, LP-S070): 24bit True Color
⑤ Plate	Designate plate color. Activated only with checking ①. <ul style="list-style-type: none"> ▪ Mono type(GP-S044, GP-S057, LP-S044): White/Black ▪ Color type(GP-S070, LP-S070): 24bit True Color
⑥ Text	Designate text color. <ul style="list-style-type: none"> ▪ Mono type(GP-S044, GP-S057, LP-S044): White/Black ▪ Color type(GP-S070, LP-S070): 24bit True Color

Basic	Description
⑦ Date	Designate to display current date
⑧ Time	Designated to display current time

5.11.2.2 Form tab

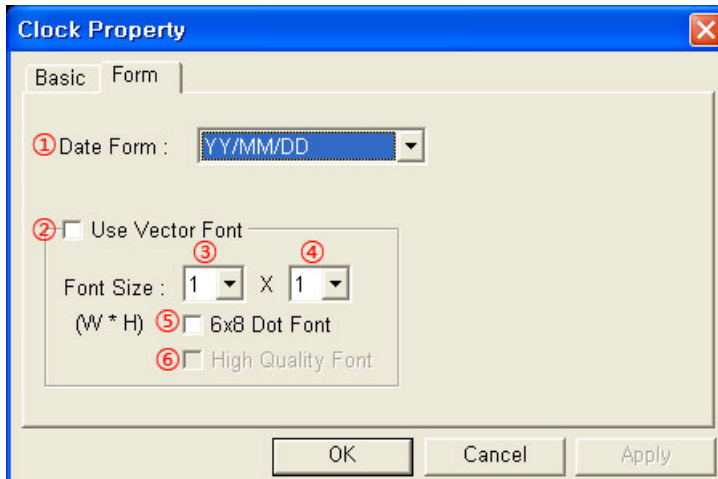

Form	Description	
① Display Type	Display Type: Date	Example of display
	YY/MM/DD: year/month/day	11/1/13
	DD/MM/YY: day/month/year	13/1/11
	MM/DD/YY: month/day/year	1/13/11
	DD/MM/YYYY(DAY): day/month/year(a day of week)	13/JAN/2011(MON)
	DD/MM/YYYY: day/month/year	13/JAN/2011
	YYYY/MM/DD: year/month/day* ¹	2011/JAN/13
	YYYY/MM/DD(DAY): year/month/day(a day of week)* ¹	2011/JAN/13(MON)
	Display Type: Time	Example of display
	24H(HH:MM): hour:minute	22:55
	24H(HH:MM:SS): hour:minute:second	22:55:36
	12H(HH:MM): hour:minute AM/PM	10:55 PM
	12H(HH:MM:SS): hour:minute:second AM/PM	10:55:36 PM
	② Use Vector Font	<p>Activated only for color type (GP-S070, LP-S070). Non-checking this, it uses bitmap font. Checking this, it displays as following.</p> <p>① Font size, ② Bold font, ③ Italic font, ④ Underline, ⑤ Strikethrough</p>

Form	Description
③ Font Size(Width)	Designate width font size by pull-down menu. <ul style="list-style-type: none"> ▪ Default =1, Range: 1,2,4,6,8 ▪ Height font size is 0.5, width font size 1 is only available. ▪ It is not activated with checking ⑤6x8 Dot Font.
④ Font Size(Height)	Designate height font size by pull-down menu <ul style="list-style-type: none"> ▪ Default =1, Range: 0.5,1,2,3,4 ▪ Width font sizes besides 1 are not available for height font size 0.5. ▪ It is not activated with checking ⑤6x8 Dot Font.
⑤6x8 Dot Font	Designate 6x8 dot font.
⑤High Quality Font	Not used

※1. YYYY/MM/DD and YYYY/MM/DD(DAY) types are supplied by only Color type(GP-S070, LP-S070) of GP/LP.

5.12 Comment Display

Comment display feature is for displaying comment depending on ON/OFF state of the designated bit device or the word device value.



Ex.

Bit action: Displays comment depending ON/OFF state of the designated bit device.

The following features are the example for the action when monitor device is set as M100,

Comment for ON state: M100 is ON.

Comment of OFF state: M100 is OFF.

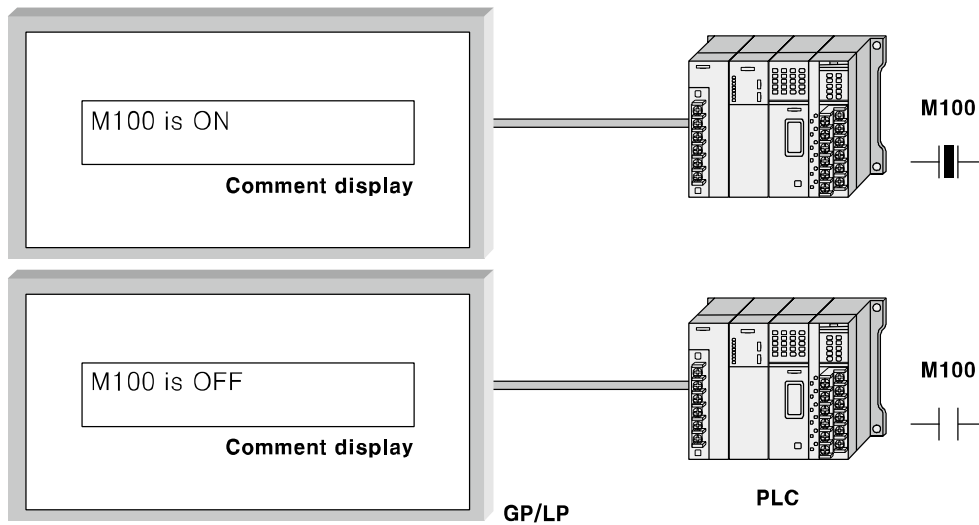

Word action: Displays comment registered in comment list depending on the designated word device value.

The following features are the example for the action when monitor device is D100,

Comment No.1 : The value of D100 is 1.

Comment No.100 : The value of D100 is 100.

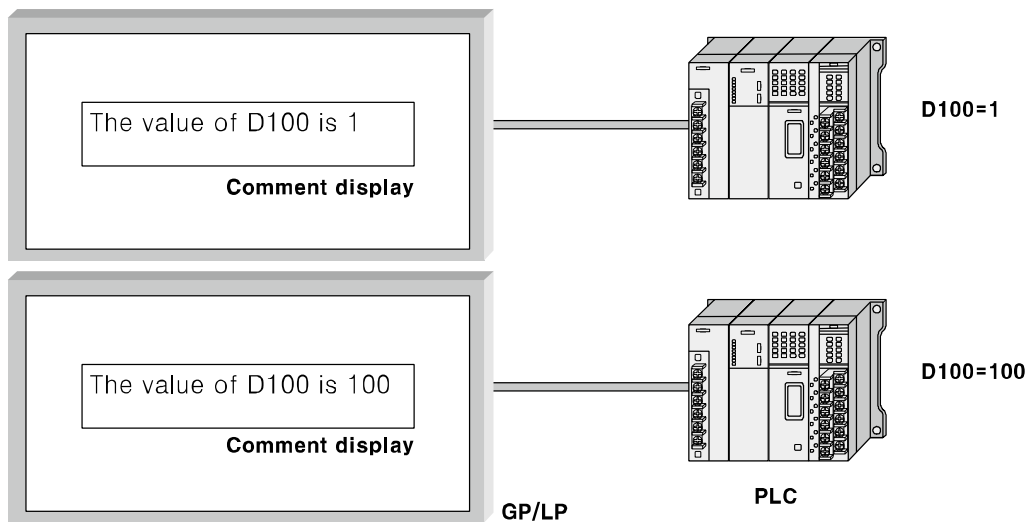

5.12.1 Basic usage

- 1st Select [Draw]-[Comment Display] or click  in tool bar, 'Comment Display Property' dialog box appears.
- 2nd Select monitor device and bit or word action in 'Basic' tab.
- 3rd Designate comment font size, or etc.
- 4th In case of bit action, 'Bit' tab is activated. Designate comment number or enter comment directly by ON/OFF.
- 5th In case of word action, 'Word' tab is activated. Designate comment number which related device value.
- 6th Click 'OK' and 'Comment Display Property' dialog box is closed. A dotted rectangle follows mouse cursor at edit area.
- 7th Place mouse cursor on the desired area, click left mouse button. Comment is placed on the screen.



Note

Size adjustment: Tag size is decided based on specified comment comparing default font size and length of comment character.
All characters including 6x8 font, 1x0.5 are reduced/enlarged as a size of configured ASCII character.

5.12.2 Property

5.12.2.1 Basic tab

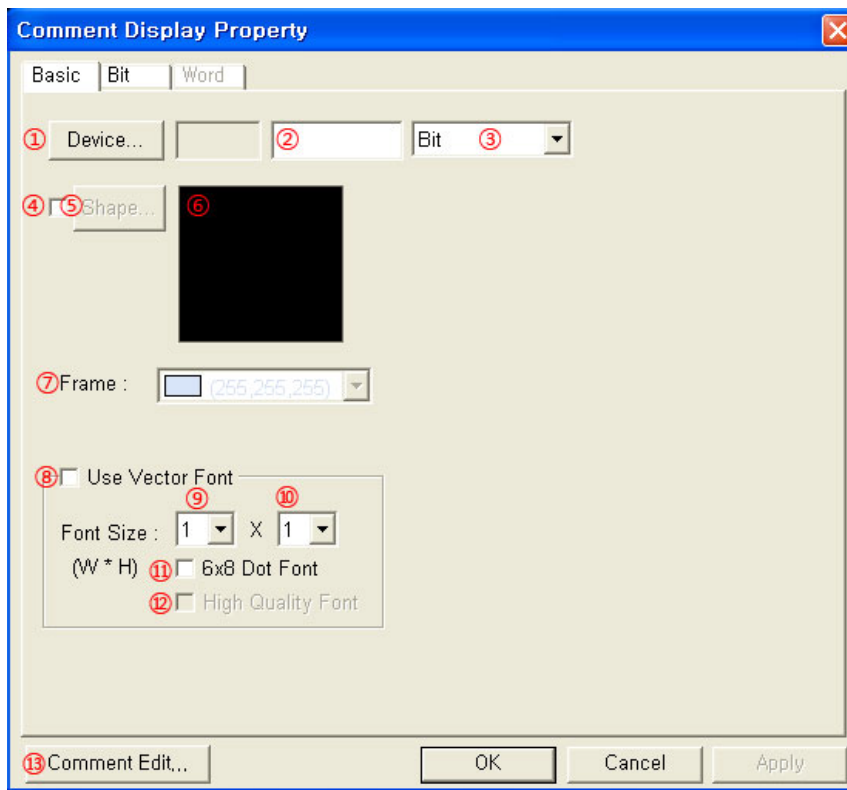

Basic	Description
① Device	Designate monitor device. Depending on ③ designation (bit or word), designate bit or word device.
② Device	Input device directly or displays the designated device by ①.
③ Type	Select device type (bit or word) by pull-down menu.
④ Shape	Designate using shape or not. Check this and no. 1 shape is as default.
⑤ Shape	Activated only with checking ④. Click 'Shape' and 'Image Selection' dialog box appears. Select the desired shape.
⑥ Shape	Displays the selected shape image.
⑦ Frame	Designate frame color. Activated only with checking ④. <ul style="list-style-type: none"> • Mono type(GP-S044, GP-S057, LP-S044): White/Black • Color type(GP-S070, LP-S070): 24bit True Color
⑧ Use Vector Font	Activated only for color type (GP-S070, LP-S070). Non-checking this, it uses bitmap font. Checking this, it displays as following. <div style="border: 1px solid black; padding: 5px; margin: 5px 0;"> <input checked="" type="checkbox"/> Use Vector Font ① Font Size : 10 ② B ③ <i>I</i> ④ <u>U</u> ⑤ ABC </div> ① Font size, ② Bold font, ③ Italic font, ④ Underline, ⑤ Strikethrough

Basic	Description
⑨ Font Size (Width)	Designate width font size by pull-down menu. <ul style="list-style-type: none">▪ Range: 1,2,4,6,8▪ Height font size is 0.5, width font size 1 is only available.
⑩ Font Size (Height)	Designate height font size by pull-down menu <ul style="list-style-type: none">▪ Default =1, Range: 0.5,1,2,3,4▪ Width font sizes besides 1 are not available for height font size 0.5.
⑪ 6x8 Dot Font	Designate 6x8 dot font
⑫ High Quality Font	Not used
⑬ Comment Edit	Calls 'Comment List' dialog box. Check or edit comment. For further details, refer to '8.7 Comment'.

5.12.2.2 Bit tab

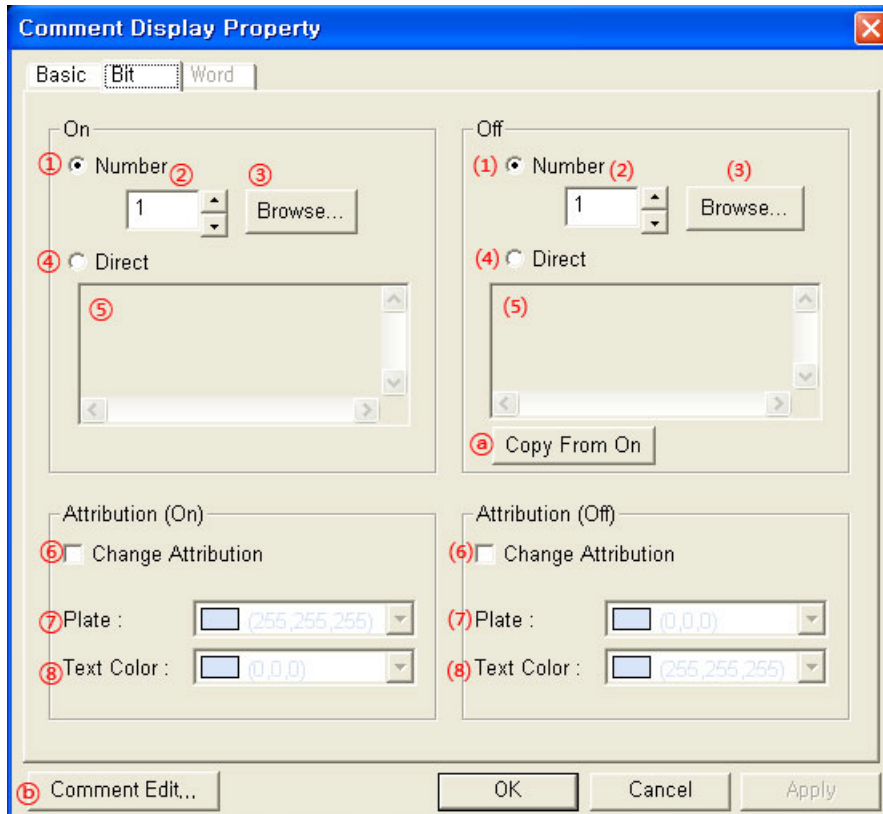

Bit	Description
①Number	Designate to use registered comment in ② for ON state.
②Number select	Designate comment number to display for ON state. Depending on monitor device state, the designated number comment is displayed.
③Browse	Designate comment number to display with arranging comment list.
④Direct	Designate to use directly input comment for ON state.
⑤Enter comment	Activated only with checking ④. Input comment directly for display.
⑥Change Attribution	Check to change plate, text color from default setting for ON state.
⑦Plate	Designate frame color for ON state. Activated only with checking 'Shape' in 'Basic' tab. <ul style="list-style-type: none"> ▪ Mono type(GP-S044, GP-S057, LP-S044): White/Black ▪ Color type(GP-S070, LP-S070): 24bit True Color
⑧Text Color	Designate text color for ON state. Activated only with checking ⑥. <ul style="list-style-type: none"> ▪ Mono type(GP-S044, GP-S057, LP-S044): White/Black ▪ Color type(GP-S070, LP-S070): 24bit True Color
(1) to (8)	Designate same setting with ① to ⑧ for OFF state.
ⒶCopy From ON	Copy the designated number or text for ON state to OFF state.
ⒷComment Edit	Calls 'Comment List' dialog box. Check or edit comment.

5.12.2.3 Word tab

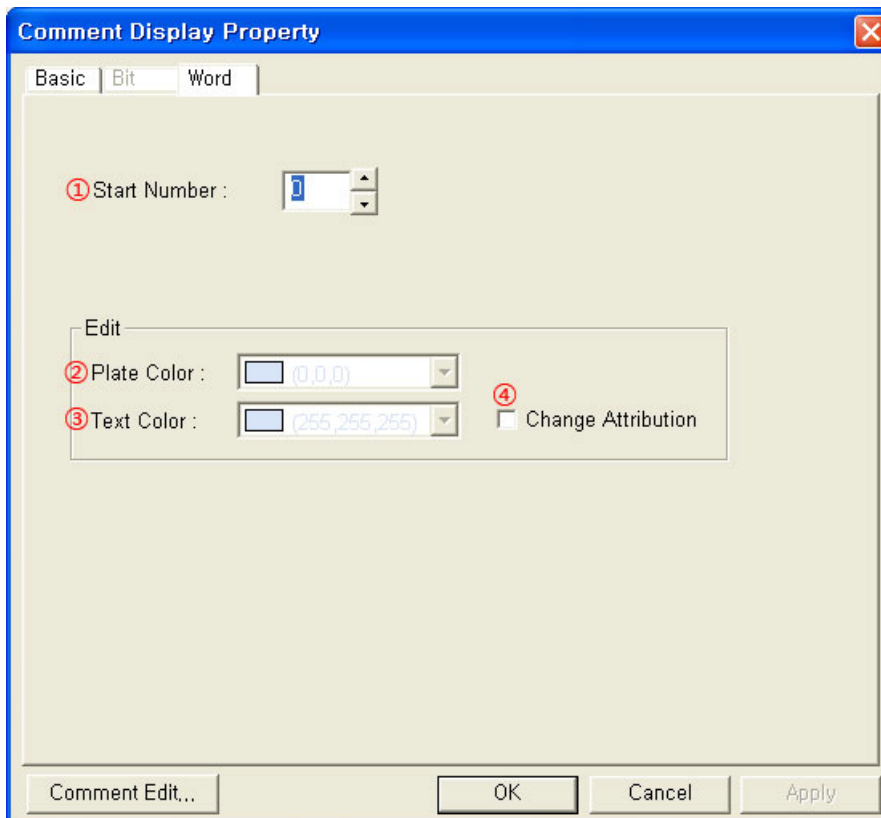

Word	Description
① Start Number	Displays the comment with word device value + start number
② Plate Color	Designates plate color. Activated only with checking 'Shape' in 'Basic' tab. <ul style="list-style-type: none"> ▪ Mono type(GP-S044, GP-S057, LP-S044): White/Black ▪ Color type(GP-S070, LP-S070): 24bit True Color
③ Text Color	Designate text color for ON state. Activated only with checking ④. <ul style="list-style-type: none"> ▪ Mono type(GP-S044, GP-S057, LP-S044): White/Black ▪ Color type(GP-S070, LP-S070): 24bit True Color
④ Change Attribution	Check to change plate, text color from default setting.

5.13 Alarm History

Alarm history is feature for recording alarm history.

It is able to record occurred time, restored time, the number of frequency by designating. You can print alarm list by connecting serial printer, check it by uploading to PC. Alarm history is the object which can exist only one on a screen.

5.13.1 Basic operation

- Records history for ON/OFF of monitor device state with time information.
- Designate observation period, action mode in 'Alarm History Property' dialog box from common configuration, designate alarm history display type in 'Alarm History Property' dialog box.
- Additional features such as detail screen display, cursor movement for specified history item selection, item deleting, etc is operated with the touch key which has the specified key code by each.
- Monitor device is 256 of successive bit device, it is able to save up to 1024 of alarms and up to 32767 of the number of occurred frequency.

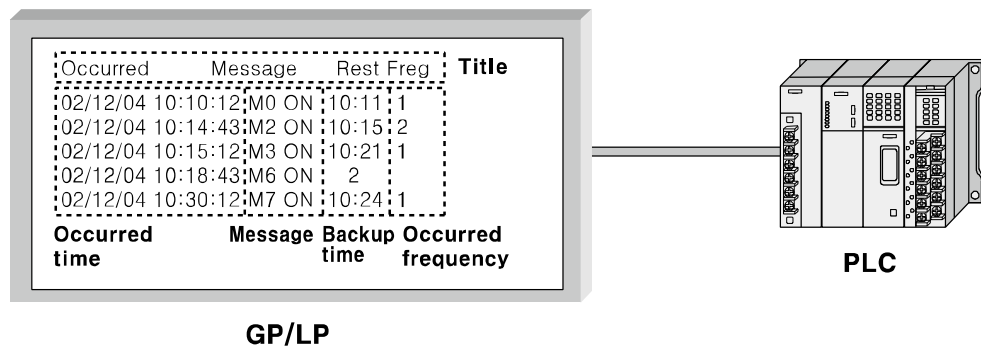

5.13.2 Basic usage

- 1st Select [Draw]-[Alarm History] of menu or click  in toolbar. 'Alarm History Property' dialog box appears.
- 2nd Click 'Common Configuration' in 'Basic' tab and 'Alarm History Property' dialog box appears.
- 3rd Designate monitor device, observation period, and mode in 'Alarm History Property' dialog box.
- 4th Designate display type in 'Alarm History Property' dialog box.
- 5th Click 'OK' and 'Alarm History Property' dialog box is closed. A dotted rectangle follows mouse cursor at edit area.
- 6th Place mouse cursor on the desired area, click left mouse button. Alarm history tag is created on the screen.

5.13.3 Property

5.13.3.1 Basic tab

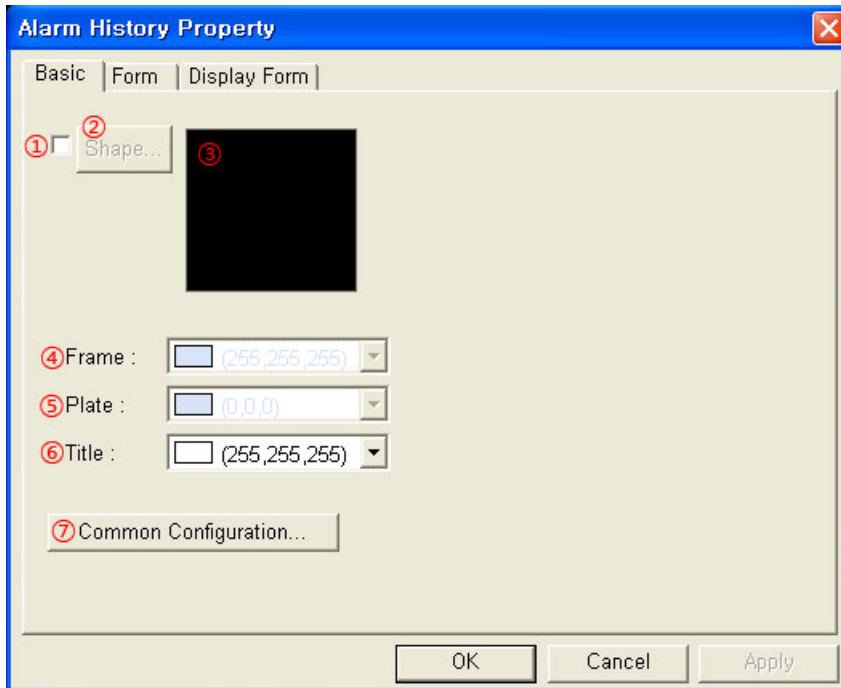

Basic	Description
① Shape	Designate using shape or not. Check this and no. 1 shape is as default.
② Shape	Activated only with checking ①. Click 'Shape' and 'Image Selection' dialog box appears. Select the desired shape.
③ Shape	Displays the selected shape image
④ Frame	Designates frame color. Activated only with checking ①. <ul style="list-style-type: none"> ▪ Mono type(GP-S044, GP-S057, LP-S044): White/Black ▪ Color type(GP-S070, LP-S070): 24bit True Color
⑤ Plate	Designates plate color. Activated only with checking ①. <ul style="list-style-type: none"> ▪ Mono type(GP-S044, GP-S057, LP-S044): White/Black ▪ Color type(GP-S070, LP-S070): 24bit True Color
⑥ Title	Designates title color. <ul style="list-style-type: none"> ▪ Mono type(GP-S044, GP-S057, LP-S044): White/Black ▪ Color type(GP-S070, LP-S070): 24bit True Color
⑦ Common Configuration	Calls 'Alarm History Property' dialog box. Designate the settings about alarm observation. For further details, refer to '8.8 Alarm History'.

5.13.3.2 Form tab

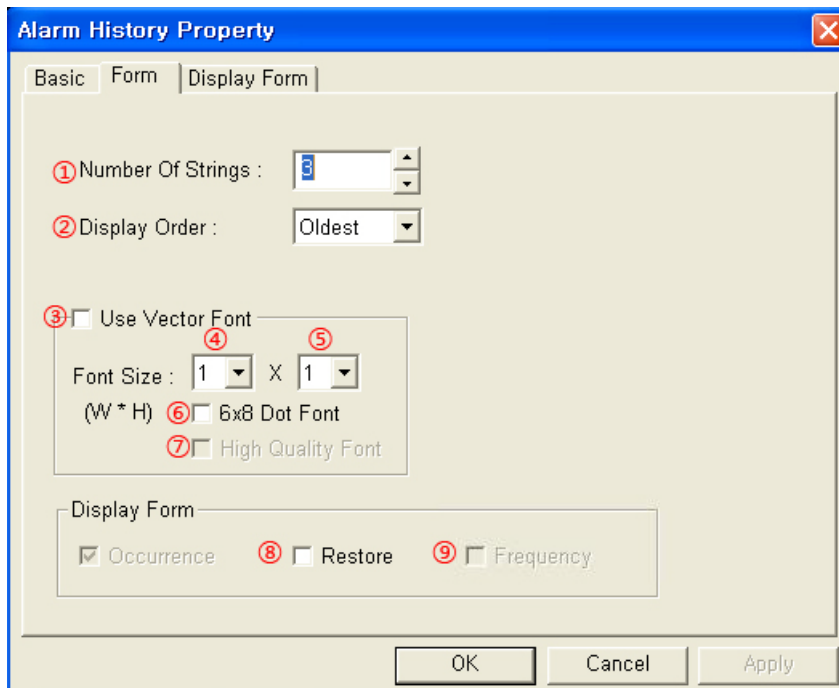

Form	Description
①Number of Strings	Designate the number of alarm item to display. Depending on height font size, there is limitation the number of item to display.
②Display Order	Designate an order to display alarm history by pull-down menu. <ul style="list-style-type: none"> ▪ Oldest: Displays older one first. ▪ Latest: Displays recent one first.
③Use Vector Font	Activated only for color type (GP-S070, LP-S070). Non-checking this, it uses bitmap font. Checking this, it displays as following. <div style="border: 1px solid black; padding: 5px; margin: 5px 0;"> <input checked="" type="checkbox"/> Use Vector Font ①Font Size : 10 ② B ③ <i>I</i> ④ <u>U</u> ⑤ AB0 </div> ①Font size, ②Bold font, ③Italic font, ④Underline, ⑤Strikethrough
④Font Size(Width)	Designate width font size by pull-down menu. <ul style="list-style-type: none"> ▪ Range: 1,2,3,4,
⑤Font Size(Height)	Designate height font size by pull-down menu <ul style="list-style-type: none"> ▪ Range: 1,2,3,4
⑥6x8 Dot Font	Designate 6x8 dot font
⑦High Quality Font	Not used
⑧Restore	Designate using display restored alarm time or not.
⑨Frequency	Designate using the number of frequency or not. Activated only with 'Cumulation' mode.

5.13.3.3 Display type tab

Alarm History Property

Basic | Form | **Display Form**

① Occurrence : ② Message : ③ Restore : ④ Frequency :

Title : OCCURRED | MESSAGE | REST. | COUNT

Width : 17⑤ (Digit) | 10⑥ (Digit) | 5⑦ (Digit)

⑧ Color : ⑨ (255,255,255) | (255,255,255)

Contents⑩ Date,Time | ⑨ Time

⑪ YY/MM/DD | ⑩ YY/MM/DD

HH:MM:SS | ⑪ HH:MM

⑫ Text : | ⑫

OK Cancel Apply

Display Form	Description
① Occurrence	Designate the row title displaying occurred time.
② Message	Designate the row title displaying message.
③ Restore	Designate the row title displaying restored time. Activated only with checking 'Restore' in display type box of 'Form' tab.
④ Frequency	Designate the row title displaying the number of frequency. Activated only with checking 'Frequency' in display type box of 'Form' tab.
⑤ Width	Displays the number of character displaying occurred time. It is designated by the setting of ⑨.
⑥ Width	Designate the number of character displaying message.
⑦ Width	Displays the number of character displaying restored time. It is designated It is designated by the setting of ⑨.
⑧ Color	Designate text color for occurred time. <ul style="list-style-type: none"> • Mono type(GP-S044, GP-S057, LP-S044): White/Black • Color type(GP-S070, LP-S070): 24bit True Color
⑨ Contents	Designate display type for occurred time by pull-down menu. <ul style="list-style-type: none"> • Date, Time: Displays data and time. Width value is fixed as digit of date display + digit of current configured time display + 1(space). • Date: Displays data. • Time: Displays time. • String: Displays user-defined text string.
⑩ Date	Designate date type for displaying by pull-down menu. <ul style="list-style-type: none"> • Select one of YY(year)/MM(month)/DD(day), MM/DD/YY, DD/MM/YY, or MM/DD.
⑪ Time	Designate time type for displaying by pull-down menu. <ul style="list-style-type: none"> • Select one of HH(hour):MM(minute):SS(second), HH:MM.

Display Form	Description
⑫ Text	Input text for the part displaying occurred time.
(9) to (12)	Activated only with checking 'Restore' in display type box of 'Form' tab. Designate same setting with ⑨ to ⑫ about restored time.

5.14 Alarm List

It displays the specified comment and ON time when the designated monitor bit device is ON.

It has similar features to alarm history but alarm list disappears when the specified device is OFF. Alarm history displays history list even though the specified device is OFF.



Ex.

Example of alarm list action when monitor device is M0, M1, and M2.

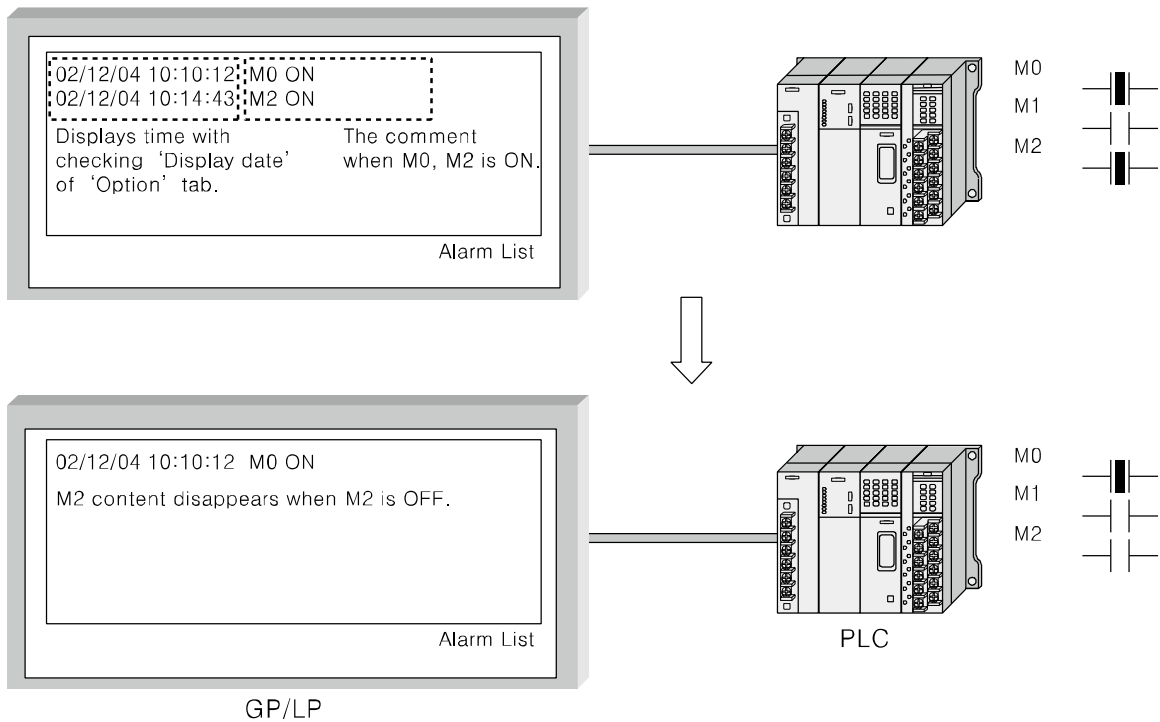

5.14.1 Basic usage

- 1st Select [Draw]-[Alarm List] of menu, or click  in toolbar. 'Alarm List Property' dialog box appears.
- 2nd Designate shape in 'Basic' tab.
- 3rd Designate the number of device, comment number, etc in 'Form' tab.
- 4th Designate the desired features to display in 'Option' tab.
- 5th Click 'OK' and 'Alarm List Property' dialog box is closed. A dotted rectangle follows mouse cursor at edit area.
- 6th Place mouse cursor on the desired area, click left mouse button. Alarm list tag is created.

5.14.2 Property

5.14.2.1 Basic tab

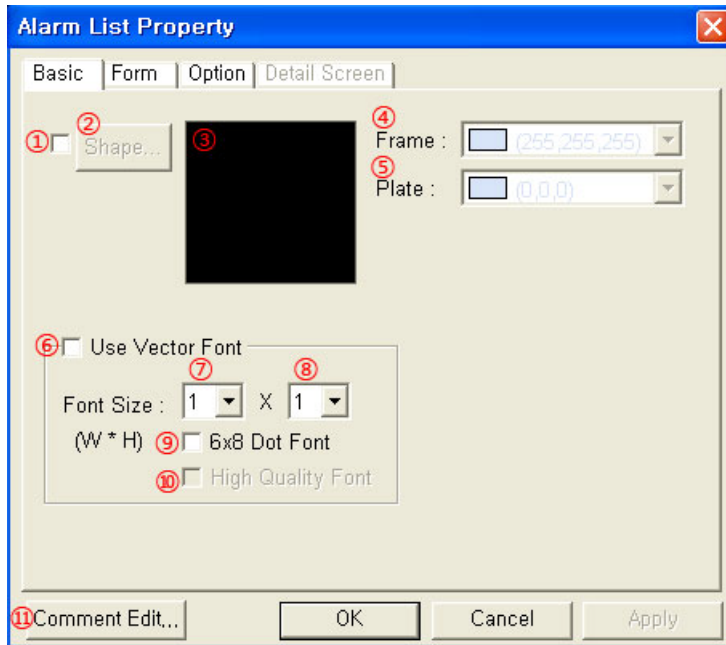

Basic	Description
①Shape	Designate using shape or not. Check this and no. 1 shape is as default.
②Shape	Activated only with checking ①. Click 'Shape' and 'Image Selection' dialog box appears. Select the desired shape.
③Shape	Displays the selected shape image.
④Frame	Designates frame color. Activated only with checking ①. <ul style="list-style-type: none"> ▪ Mono type(GP-S044, GP-S057, LP-S044): White/Black ▪ Color type(GP-S070, LP-S070): 24bit True Color
⑤Plate	Designates plate color. Activated only with checking ①. <ul style="list-style-type: none"> ▪ Mono type(GP-S044, GP-S057, LP-S044): White/Black ▪ Color type(GP-S070, LP-S070): 24bit True Color
⑥Use Vector Font	Activated only for color type (GP-S070, LP-S070). Non-checking this, it uses bitmap font. Checking this, it displays as following. <div style="border: 1px solid gray; padding: 5px; margin: 5px 0;"> <input checked="" type="checkbox"/> Use Vector Font ①Font Size : 10 ②B ③I ④U ⑤ABO </div> ①Font size, ②Bold font, ③Italic font, ④Underline, ⑤Strikethrough
⑦Font Size(Width)	Designate width font size by pull-down menu. <ul style="list-style-type: none"> ▪ Range: 1,2,3,4,5,6,7,8 ▪ Height font size is 0.5, width font size 1 is only available.

Basic	Description
⑧ Font Size(Height)	Designate height font size by pull-down menu <ul style="list-style-type: none"> Range: 0.5, 1, 2, 3, 4, 5, 6, 7, 8 Width font sizes besides 1 are not available for height font size 0.5.
⑨ 6x8 Dot Font	Designate 6x8 dot font.
⑩ High Quality Font	Not used
⑪ Comment Edit	Calls 'Comment List' dialog box. Check or edit comment.

5.14.2.2 Form tab

Form	Description
① Number of Device	Designate the number of monitor device related with alarm list. <ul style="list-style-type: none"> Range: 1 to 256
② Device	Calls 'Device Select' dialog box, and designate device. From this device, successive bit devices of ① the number are monitor device of alarm list.
③ Device	Input device directly or displays the designated device.
④ Save	Check to save the number of monitor device which is ON state (the number of occurred alarm) at the specified word device.
⑤ Device	Calls 'Device Select' dialog box and designate word device to save the number of occurred alarm.
⑥ Device	Input device directly or displays the designated word device by ①.
⑦ Comment Number	Designate comment number to be displayed when the lead device is ON. Next device from the lead device corresponds successively with high number of comment than designated number.
⑧ Browse	Calls 'Comment List' dialog box. Check the desired comment.

Form	Description
⑨ Number Of Display	Designate using one comment display or more on screen by pull-down menu. <ul style="list-style-type: none"> Plural: Displays two or more comments (error message) on screen display area. Single: Displays one of the latest alarms.
⑩ Alignment	Designate alarm alignment type by pull-down menu. <ul style="list-style-type: none"> Ascending: Displays from high number according to bit device number. Descending: Displays from low number according to bit device number. Oldest: Displays older one first. Latest: Displays recent one first.

5.14.2.3 Option tab

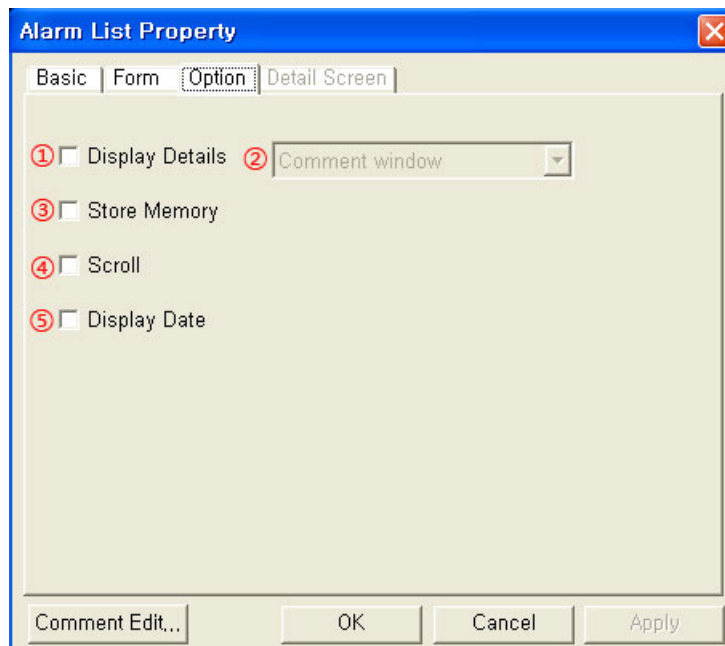

Option	Description
① Detail Display	Designate displaying detail display by function key (touch key) or not. Place cursor on the specified area on alarm list, touch the function key for detail screen display. Depending on the designation of ②, the related alarm detail is displayed with window or base screen type.
② Detail Display	Designate screen type of detail display by pull-down menu. <ul style="list-style-type: none"> Comment window: Displays details with comment window type. Base screen: Displays details with base screen type.
③ Store Memory	Saves ON date and time of current monitor device in real time.* ¹
④ Scroll	Designate using scroll to check all alarms when there are several alarms and these are not displayed at one tag area or not. Shows cursor by show cursor touch key (key code is FFA4h), and scroll it with move cursor upward (FFABh), move cursor downward (FFACh) touch keys. Scroll option cannot be placed with alarm history in one screen.
⑤ Display Date	Designate displaying both date and time with comment all the time or not. With non-checking this, displays only the comment of the specified bit device.

※1. The below alarm list content table is for when to be monitored devices are M0, M1, and M2 and alarm list tag is placed at base screen 1. And for when actual ON time of monitor device is M0:02/08/08 12:01, M1 : 02/08/08 12:10, M2:02/08/08 12:20 and switching time from base screen 2 to screen1 is 12:18.

Checking store memory		Non-checking store memory	
M0	02/08/08 12:01 M0 error	M0	02/08/08 12:18 M0 error
M1	02/08/08 12:10 M1 error	M1	02/08/08 12:18 M1 error
M2	02/08/08 12:20 M2 error	M2	02/08/08 12:18 M2 error

5.14.2.4 Detail screen tab

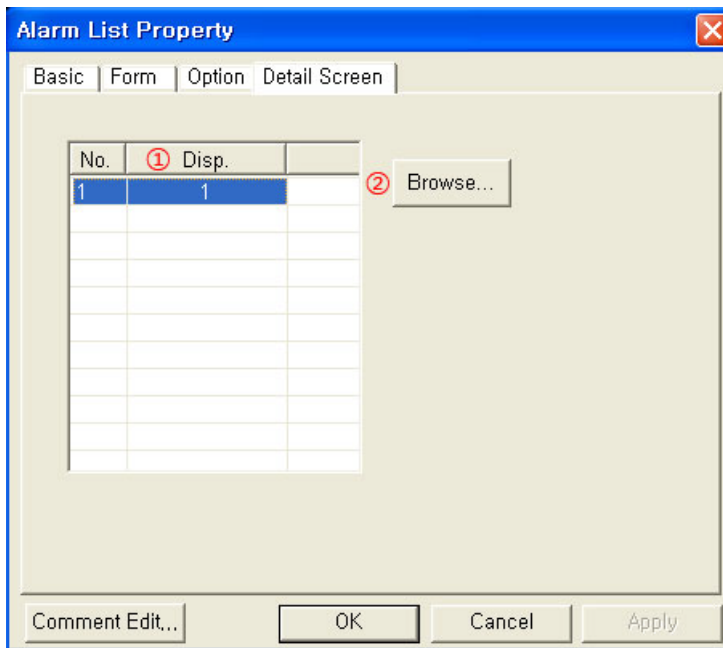

Detail Screen	Description
① Display Number	After checking 'Display Details' and selecting screen type in 'Option' tab, displays detail comment number or base screen number depending on screen type.
② Browse	After checking 'Display Details' and selecting screen type in 'Option' tab, click this. In case of 'Comment window' screen type, 'Comment List' dialog box appears. Designate comment number. In case of 'Base screen' screen type, 'Screen Image' dialog box appears. Designate the base screen to display details.

5.14.2.5 Alarm detail information

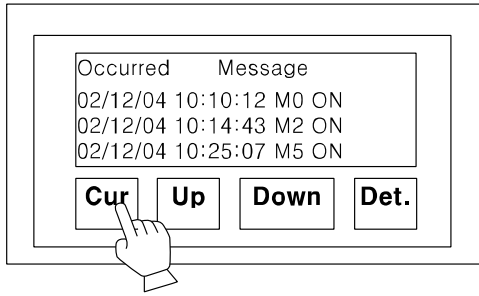

Display cursor with cursor display key.

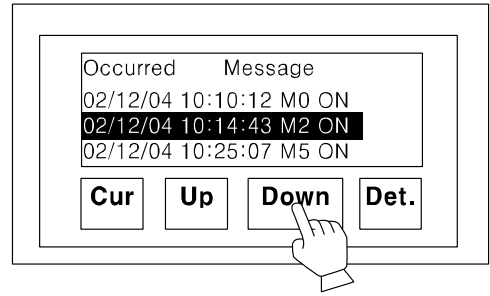
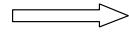

Select item to read detail information with Up/Down key.

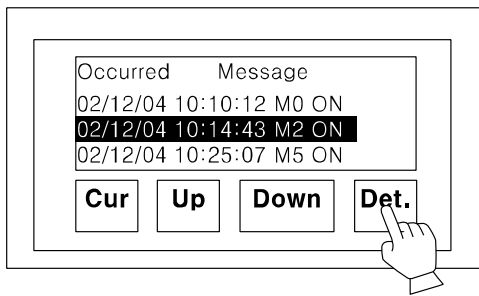

Press detail key (FFA6h).

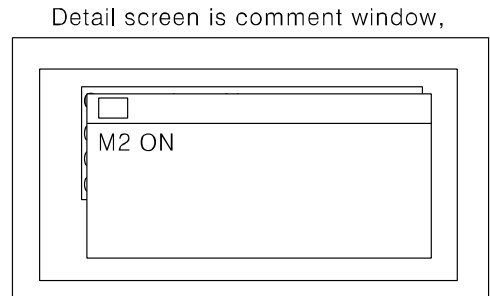
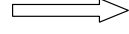

Detail screen is comment window,

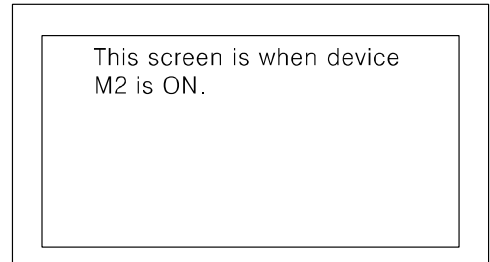

Detail screen is base window,

5.15 Part Display

Displays part depending on the designated bit device state, or on the word device value on screen.



Ex.

(1) Bit action

It displays the designated part depending on ON/OFF state of bit device.

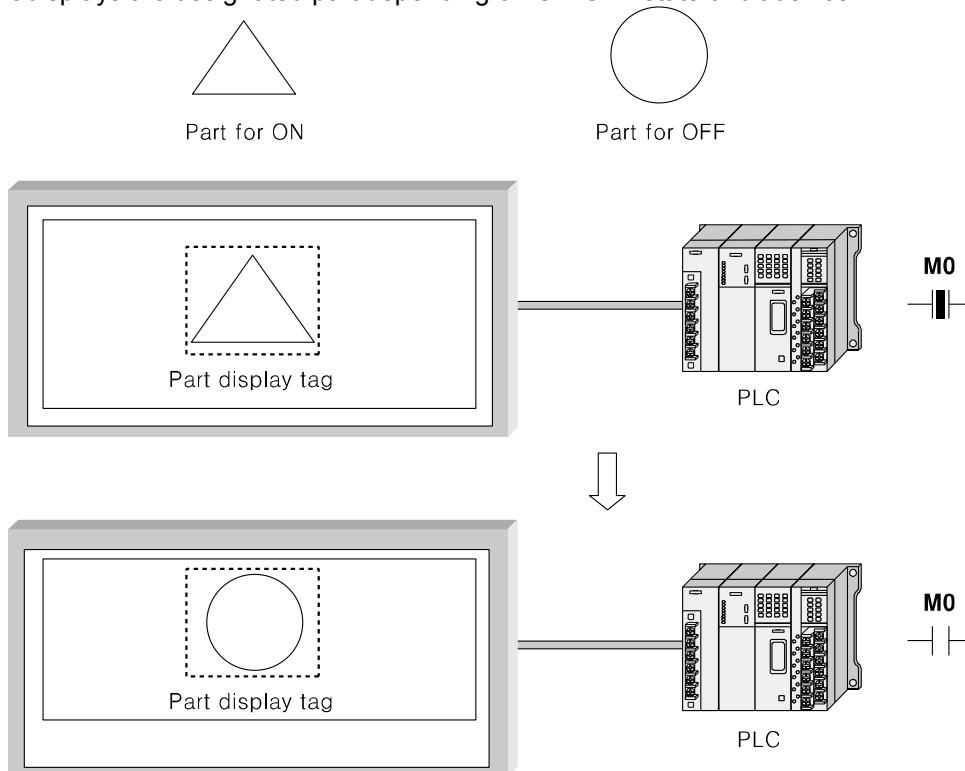

When using mark option, it shows the specified part with changing from white to the designated color of foreground and background color according to device state, not switching part.

(2) Word action

It displays the part with switching depending on word device value.

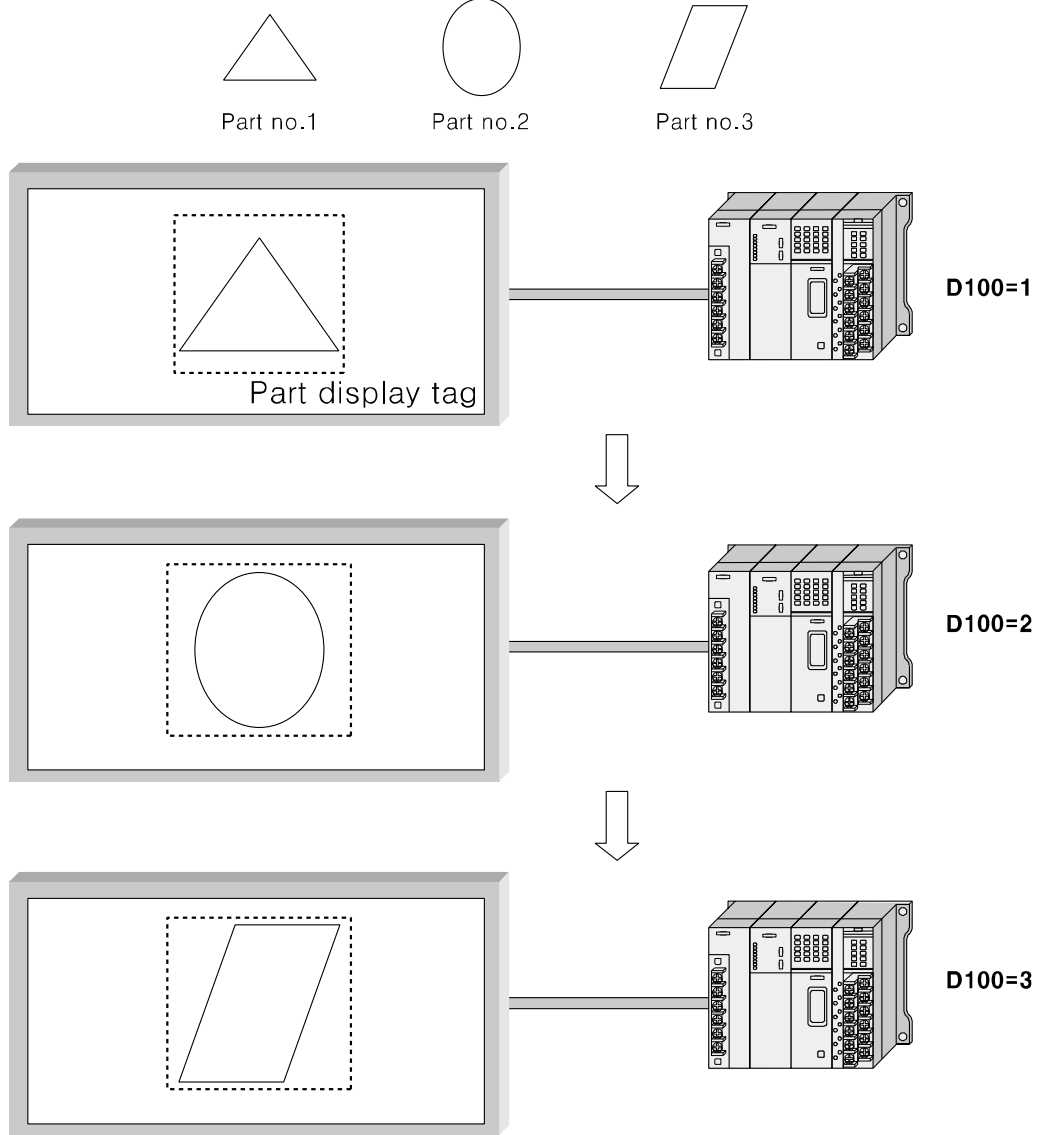

5.15.1 Basic usage

- 1st Select [Draw]-[Part Display] of menu, click  in toolbar. 'Part Display Property' dialog box appears.
- 2nd Designate part switching in 'Basic' tab.
- 3rd In case of device part switching, select 'Device'. In case of fixed part switching, select 'Fixed' and designate part number.
- 4th In case of bit device, designate part for ON/OFF, color in 'Bit' tab.
- 5th In case of word device, designate start number in 'Word' tab.
- 6th Click 'OK' and 'Part Display Property' dialog box is closed. A dotted rectangle follows mouse cursor at edit area.
- 7th Place mouse cursor on the desired area, click left mouse button. Part tag is created on the screen.

5.15.2 Property

5.15.2.1 Basic tab

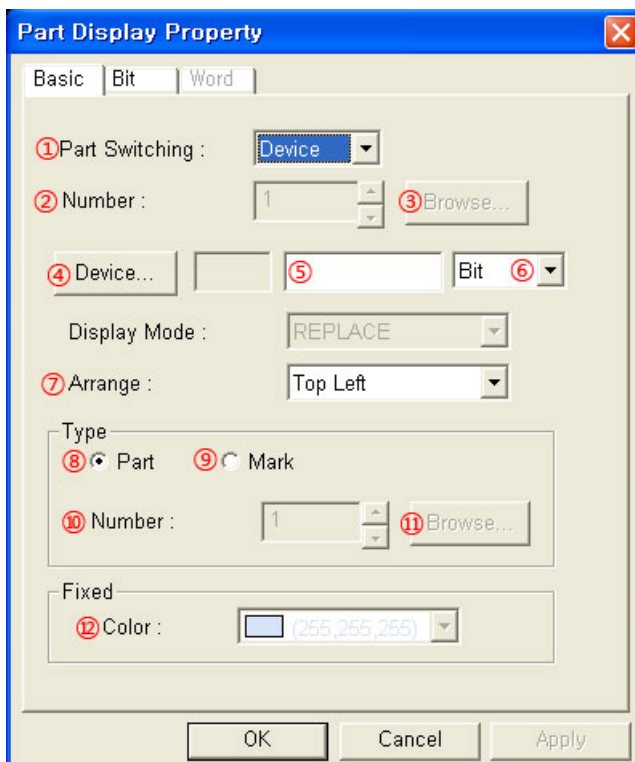

Basic	Description
① Part Switching	Select device or fixed by pull-down menu. <ul style="list-style-type: none"> ▪ Device: Switching part depending on the specified bit device state or the word device value. ▪ Fixed: Displays one specified part.
② Number	Activated with only when ① is set as 'Fixed'. Designate part number to display.
③ Browse	Calls 'Image Selection' dialog box and select the part registered at part library. The selected part number is input at ②.

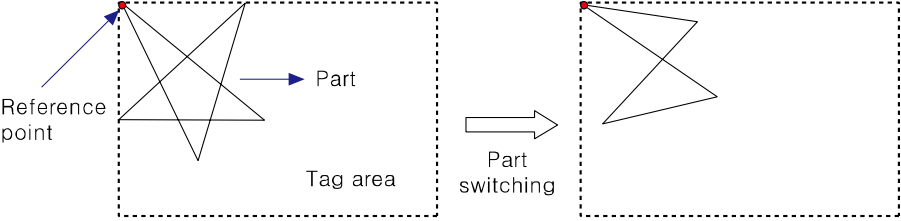
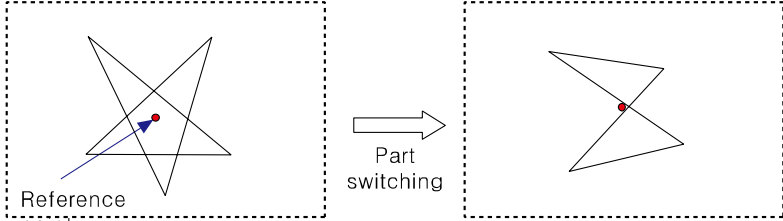
Basic	Description
④Device	<p>Activated with only when ① is set as 'Device'.</p> <p>Depending on the designation of ⑥, designate bit/word device.</p> <ul style="list-style-type: none"> Bit device: Displays the part which is designated in 'Bit' tab depending on ON/OFF state of the specified bit device. Word device: Displays the part which is related with part number of the word device value.
⑤Device	Input device directly or displays the designated device.
⑥Data Type	Select bit device or word device for part switching by pull-down menu.
⑦Arrange	<ul style="list-style-type: none"> Top Left: Places top-left point of part in center of tag area.  <ul style="list-style-type: none"> Center: Places center point of part in center of tag area. 
⑧Part	<ul style="list-style-type: none"> In case of 'Fixed' part switching, displays the part designated in ②. In case of 'Device' part switching, displays the part designated at ON/OFF in 'Bit' tab.
⑨Mark	<p>Activated only with when the designation of ⑥ is bit device.</p> <ul style="list-style-type: none"> In case of 'Fixed' part switching, <ul style="list-style-type: none"> For mono type(GP-S044, GP-S057, LP-S044), displays mark with switching from white area of the designated part of ② to designated color of ⑫. For color type(GP-S070, LP-S070), displays mark with switching from white foreground area of the designated part of ② to designated color of ⑫. In case of 'Device' part switching, <ul style="list-style-type: none"> For mono type(GP-S044, GP-S057, LP-S044), displays mark with switching from white area of the designated part of ⑩ to designated On/Off color in 'Bit' tab. For color type(GP-S070, LP-S070), displays mark with switching from white foreground area of the designated part of ⑩ to designated On/Off color in 'Bit' tab. <p>Mono type(GP-S044, GP-S057, LP-S044) uses only white/black. If mart color is black and background color is black, part is not to be seen.</p>
⑩Number	<p>Activated only with when ① part switching is 'Device', and checking ⑨.</p> <p>Designate part to display when using mark option.</p>
⑪Browse	Calls 'Image Selection' dialog box. Designate the part to display when using mark option.

Basic	Description
⑫ Color	<p>Activated only with when ① part switching is 'Fixed', and checking ⑨. White area of the designated part of ② is changed to the designated color of this.</p> <p>If color is same with background color, part is not to be seen.</p> <ul style="list-style-type: none"> • Mono type(GP-S044, GP-S057, LP-S044): White/Black • Color type(GP-S070, LP-S070): 24bit True Color

5.15.2.2 Bit tab

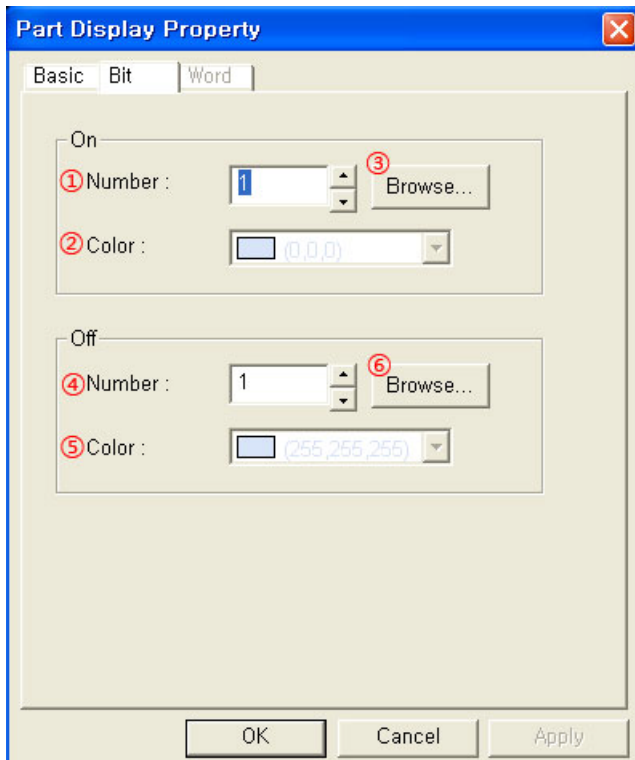

Bit	Description
①, ④ Number	<p>Designate part number to display for ON/OFF.</p> <p>Activated only with when 'Part' in type box is selected in 'Basic' tab.</p>
②, ⑤ Color	<p>Activated only with when 'Mart' in type box is selected in 'Basic' tab.</p> <p>Displays the white area of the designated device for ON/OFF to the designated color of ③, ⑥.</p> <p>If color is same with background color, part is not to be seen.</p> <ul style="list-style-type: none"> • Mono type(GP-S044, GP-S057, LP-S044): White/Black • Color type(GP-S070, LP-S070): 24bit True Color
③, ⑥ Browse	<p>Calls 'Image Selection' dialog box. Designate part number to display for ON/OFF.</p>

5.15.2.3 Word tab

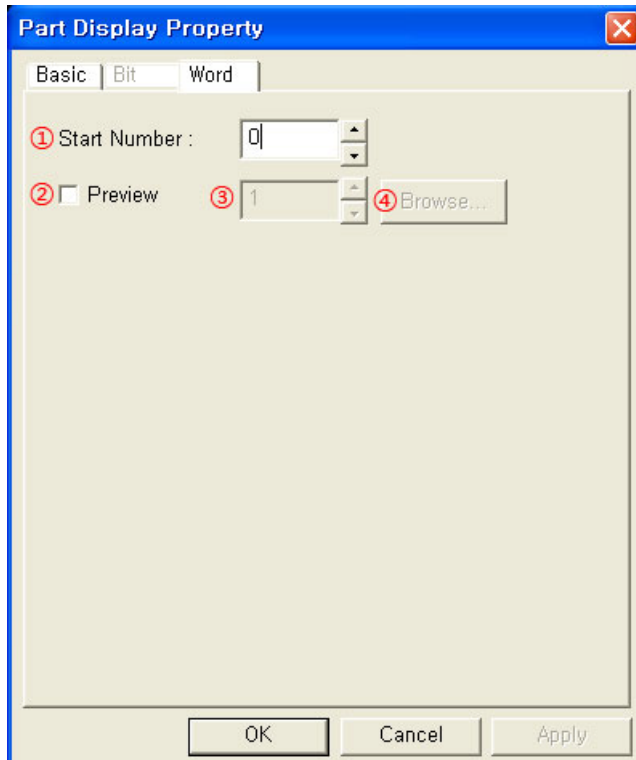

Word	Description
① Start Number	Designate part number to display when the designated word device is 0. Displays the part of word device value +start number. Default is 0 and range is -32768 to 32767. If word device value+start number is below 0, it does not display anything.
② Preview	Designate using part display on edit area or not. Checking this, the part input at spin box is displayed on edit area. Non-checking this, tag area is only displayed.
③ Preview	Designate part number to display on edit area.
④ Browse	Call 'Image Selection' dialog box. Select the part registered part library and the selected part number is input at ③.

5.16 Lamp

Lamp feature is for lamp to turn ON/OFF depending ON/OFF of bit device.

You can use graph library supported by GP Editor, and user-defined part as lamp shape.

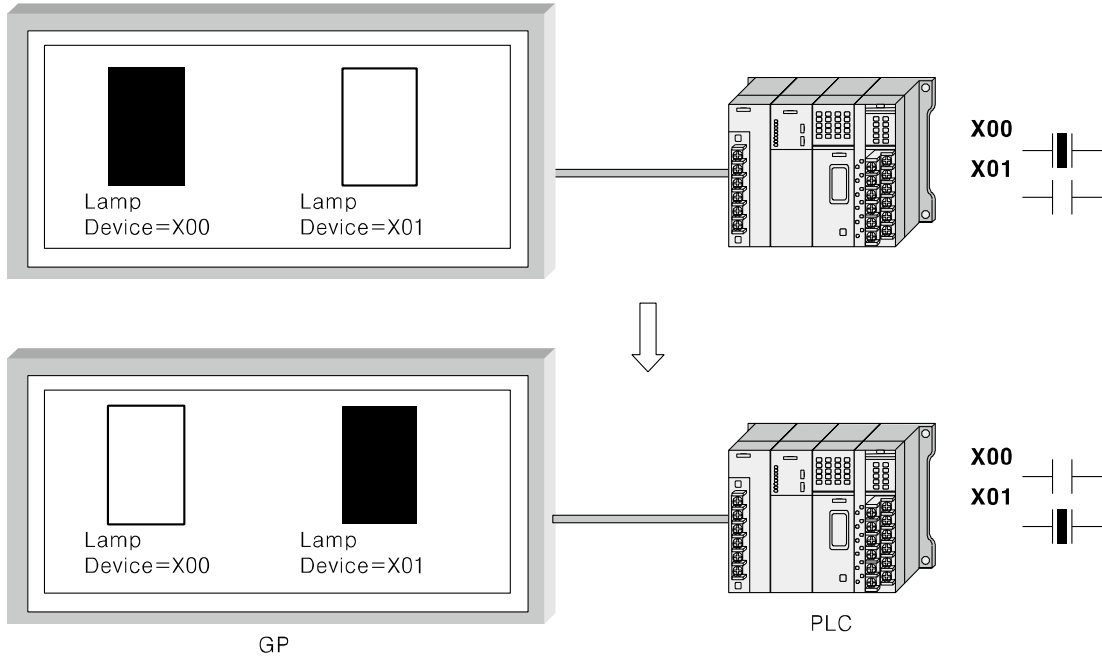

5.16.1 Basic usage

- 1st Select [Draw]-[Lamp] of menu, click  in toolbar. 'Lamp Property' dialog box appears.
- 2nd Designate lamp shape.
- 3rd Designate monitor device and other properties.
- 4th Click 'OK' and 'Lamp Property' dialog box is closed. A dotted rectangle follows mouse cursor at edit area.
- 5th Place mouse cursor on the desired area, click left mouse button. Lamp is created on the screen. When using basic figure shape lamp which is supplied by GP Editor, minimum lamp size is 16X16 dots. When using user-defined part shape lamp, it includes ON/OFF part and its rectangle size is 16X16 and over.

5.16.2 Property

5.16.2.1 Basic tab

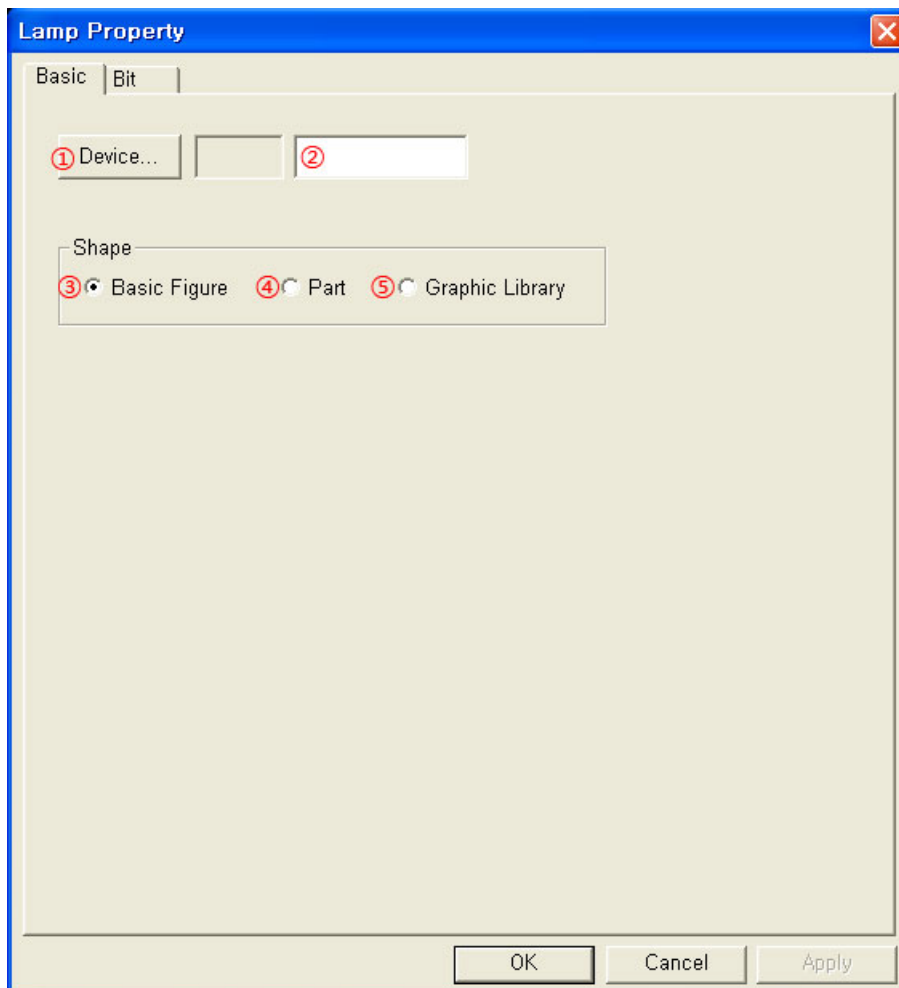

Basic	Description
① Device	Calls 'Device Select' dialog box and designate monitor device.
② Device	Input PLC device directly or displays the designated device.
③ Basic Figure	Uses basic black/white image supported GP Editor as lamp shape.
④ Part	Uses user-defined part as lamp shape.
⑤ Graphic Library	Uses bitmap image supported GP Editor and registered image as lamp shape. (Available only for color type(GP-S070, LP-S070))

5.16.2.2 Bit tab

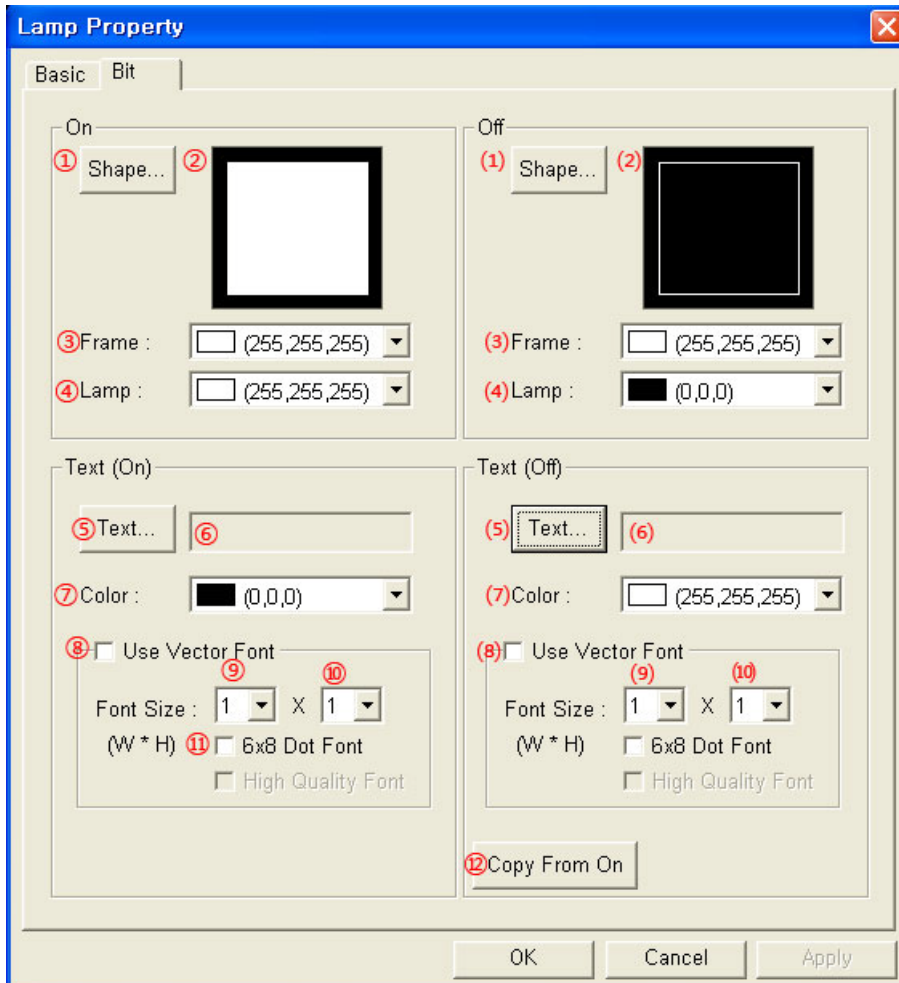

Bit	Description
① Shape	Depending on the designation of shape in 'Basic' tab, this ① is different. <ul style="list-style-type: none"> Basic Figure: Designate lamp shape from listed basic black/white image supplied by GP Editor. Part: Designate lamp shape from listed user-defined part. Graphic Library: Designate lamp shape from listed bitmap image supplied by GP Editor.
② Shape	Displays the selected shape image.
③ Frame	Designates frame color for ON. Activated only with when 'Basic Figure' is selected in shape box of 'Lamp Property' dialog box. <ul style="list-style-type: none"> Mono type(GP-S044, GP-S057, LP-S044): White/Black Color type(GP-S070, LP-S070): 24bit True Color
④ Lamp	Designates lamp color for ON. Activated only with when 'Basic Figure' is selected in shape box of 'Lamp Property' dialog box. <ul style="list-style-type: none"> Mono type(GP-S044, GP-S057, LP-S044): White/Black Color type(GP-S070, LP-S070): 24bit True Color
⑤ Text* ¹	Calls 'Edit Text' dialog box. Edit text for ON lamp.
⑥ Text	Displays text for ON lamp.

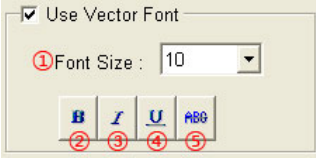
Bit	Description
⑦ Color	Designates text color. <ul style="list-style-type: none"> • Mono type(GP-S044, GP-S057, LP-S044): White/Black • Color type(GP-S070, LP-S070): 24bit True Color
⑧ Use Vector Font	Activated only for color type (GP-S070, LP-S070). Non-checking this, it uses bitmap font. Checking this, it displays as following. <div style="text-align: center;">  </div> <p>① Font size, ② Bold font, ③ Italic font, ④ Underline, ⑤ Strikethrough</p>
⑨ Font Size (Width)	Designate width font size by pull-down menu. <ul style="list-style-type: none"> • Range: 1,2,4,6,8 • Height font size is 0.5, width font size 1 is only available.
⑩ Font Size (Height)	Designate height font size by pull-down menu <ul style="list-style-type: none"> • Range: 0.5,1,2,3,4 • Width font sizes besides 1 are not available for height font size 0.5.
⑪ 6x8 Dot Font	Designate 6x8 dot font.
(1) to (10)	Designate same setting with ① to ⑩ for OFF state.
⑫ Copy From On	Copy the designated text for ON state to OFF state.

※1. [Text display on lamp]

Click ⑤, (5) 'Text' and 'Edit Text' dialog box appears. You can input the text for lamp and designate the place.

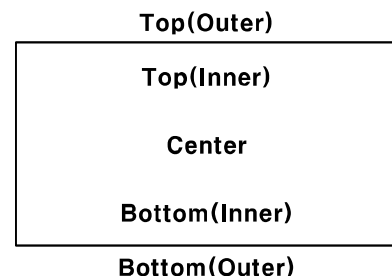
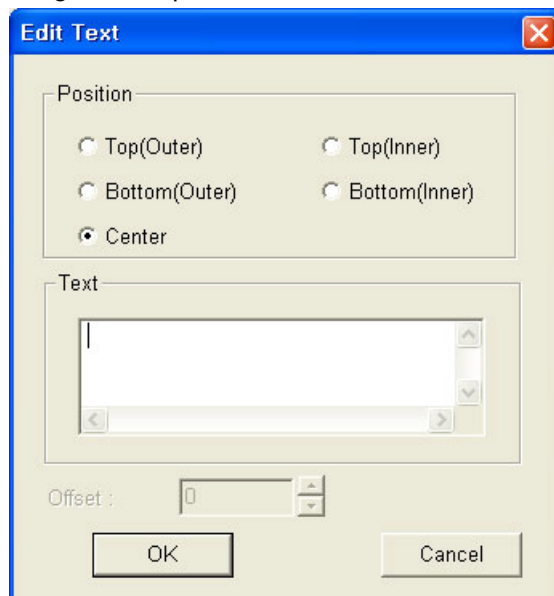

5.17 Panel Meter

Panel meter is displaying the occupied position of current value of specified word device within designated maximum/minimum value with needle of panel meter to monitor device value.



Ex.

The example for when panel meter range is 0 to 100, D50 is 40. The needle of panel meter indicates the appropriate value for 40.

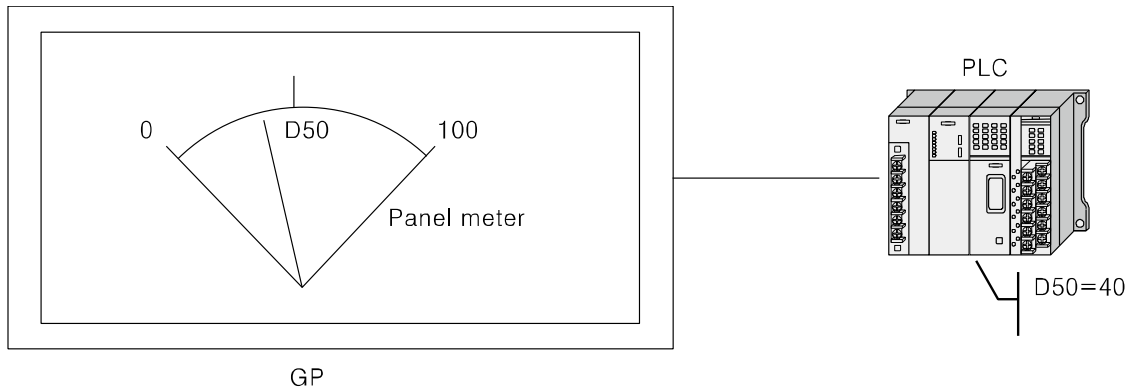

5.17.1 Basic usage

- 1st Select [Draw]-[Panel Meter] of menu, or click  in toolbar. 'Panel Meter' dialog box appears.
- 2nd Designated word device for observation in 'Basic' tab.
- 3rd Designate panel meter type, direction for needle in 'Form' tab.
- 4th Designate data type of device, maximum/minimum value.
- 5th Click 'OK' and 'Panel Meter' dialog box is closed. A dotted rectangle follows mouse cursor at edit area.
- 6th Place mouse cursor on the desired area, click left mouse button. Panel meter is placed on the screen.

5.17.2 Property

5.17.2.1 Basic tab

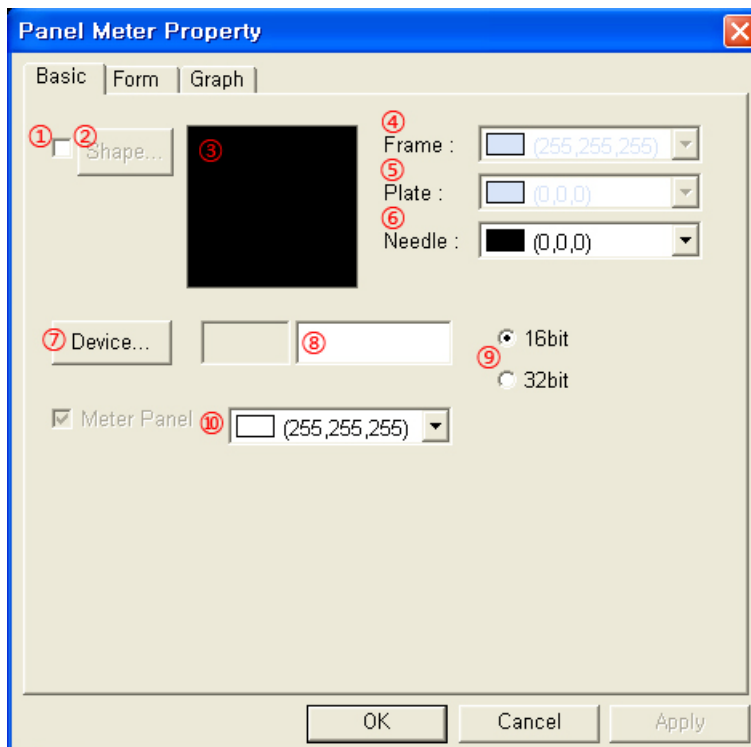

Basic	Description
①Shape	Designate using shape or not. Check this and no. 1 shape is as default.
②Shape	Activated only with checking ①. Click 'Shape' and 'Image Selection' dialog box appears. Select the desired shape.
③Shape	Displays the selected shape image
④Frame	Designate frame color. Activated only with checking ①. <ul style="list-style-type: none"> • Mono type(GP-S044, GP-S057, LP-S044): White/Black • Color type(GP-S070, LP-S070): 24bit True Color
⑤Plate	Designate plate color. Activated only with checking ①. <ul style="list-style-type: none"> • Mono type(GP-S044, GP-S057, LP-S044): White/Black • Color type(GP-S070, LP-S070): 24bit True Color
⑥Needle	Designate needle color. <ul style="list-style-type: none"> • Mono type(GP-S044, GP-S057, LP-S044): White/Black • Color type(GP-S070, LP-S070): 24bit True Color
⑦Device	Calls 'Device Select' dialog box and designate monitor device.
⑧Device	Input device directly or displays the designated device by ⑦
⑨Data	Designate data type (16bit or 32bit) of word device. Depending on connected device type, it may use only 32bit. Refer to 'GP,LP user manual for communication'.
⑩Meter Panel	Designate panel meter color.

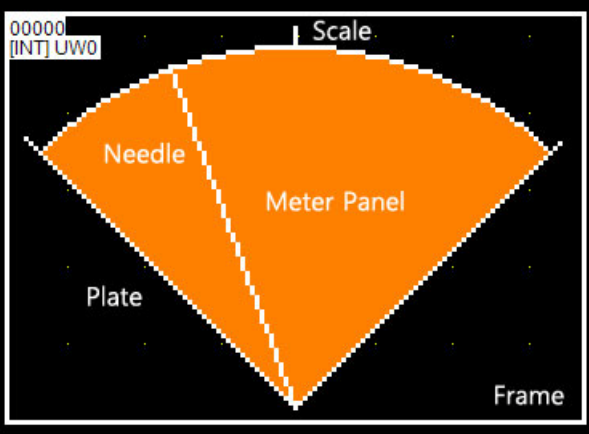
Basic	Description
<p>Component of panel meter</p>	 <p>The diagram illustrates the components of a panel meter. It features a semi-circular orange area representing the meter's face. At the top center of this face is a vertical line labeled 'Scale'. A white needle is shown pointing towards the scale, labeled 'Needle'. The entire orange face is labeled 'Meter Panel'. The base of the meter is a black trapezoidal shape labeled 'Plate'. The entire assembly is enclosed within a black rectangular border labeled 'Frame'. In the top-left corner of the meter face, there is a small white box containing the text '00000' and '[INT] UWO'.</p>

5.17.2.2 Form tab

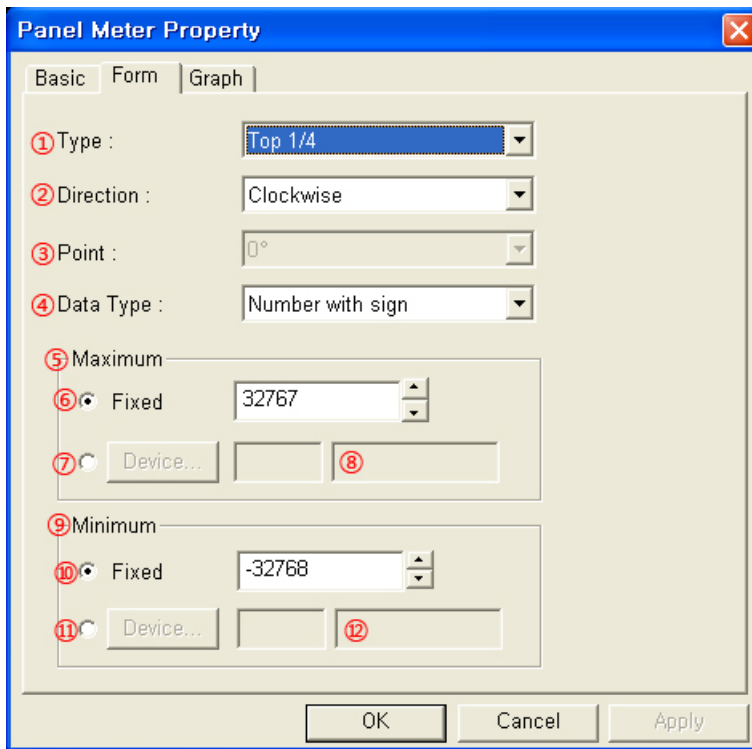

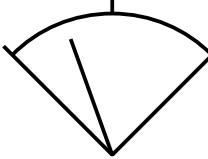
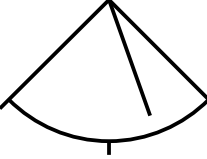
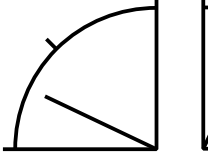
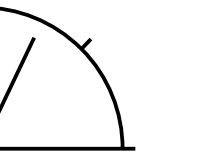
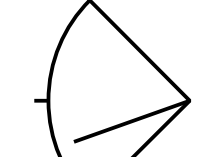
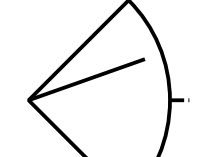
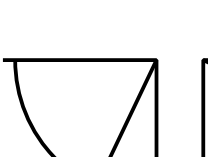
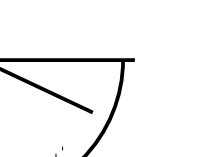
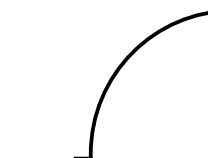
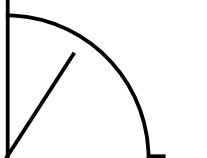
Form	Description
<p>①Type</p>	<p>Designate panel meter shape by pull-down menu.</p> <ul style="list-style-type: none"> Top 1/4, Bottom 1/4, Left 1/4, Right 1/4, Top Right 1/4, Top Left 1/4, Bottom Left 1/4, Bottom Right 1/4, Top 1/2, Bottom 1/2, Left 1/2, Right 1/2, 3/4, Circle <div style="display: flex; flex-wrap: wrap; justify-content: space-around; text-align: center;"> <div style="margin: 5px;"> Top 1/4</div> <div style="margin: 5px;"> Bottom 1/4</div> <div style="margin: 5px;"> Top Left 1/4</div> <div style="margin: 5px;"> Top Right 1/4</div> <div style="margin: 5px;"> Left 1/4</div> <div style="margin: 5px;"> Right 1/4</div> <div style="margin: 5px;"> Bottom Left 1/4</div> <div style="margin: 5px;"> Bottom Right 1/4</div> <div style="margin: 5px;"> Left 1/2</div> <div style="margin: 5px;"> Right 1/2</div> </div>

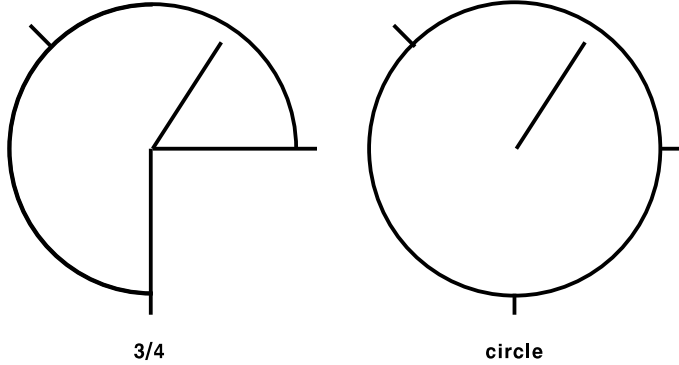
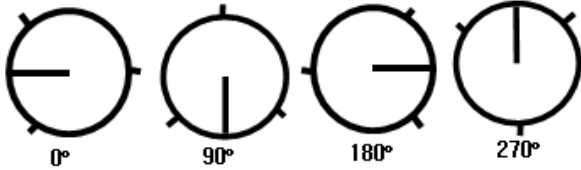
Form	Description
①Type	 <p style="text-align: center;">3/4 circle</p>
②Direction	Designate moving direction of needle as device value is bigger by pull-down menu. Select one of clockwise or counter clockwise.
③Point	<p>Activated only with when ①Type is 'Circle'. Designate the frame position for scale by pull-down menu.</p> <ul style="list-style-type: none"> Range: 0°, 90°, 180°, 270° <p>The start point of needle designated in a point is +180°. Point=p, Number Of Scale=N, scale position degree=p, p+360°/N, p+2*360°/N, ..., p+(N-1)*360°/N Shape according to point designation for number of scale is 3</p>  <p style="text-align: center;">0° 90° 180° 270°</p>
④Data Type	Designate data type of the designated device by pull-down menu. <ul style="list-style-type: none"> Number with sign: Processes as number with sign reading device Number without sign: Processes as number without sign reading device
⑤Maximum	<ul style="list-style-type: none"> Fixed: Fixed value is maximum value with needle of panel meter. Not Fixed: Designated word device value is maximum value.
⑥Fixed	Designate fixed maximum value.
⑦Device	Calls 'Device Select' dialog box. Designate maximum device.
⑧Device	Input device directly or displays the designated device by ⑦
⑨ to ⑫ Minimum	Designate same setting with ⑤ to ⑧ for minimum.

5.17.2.3 Graph tab

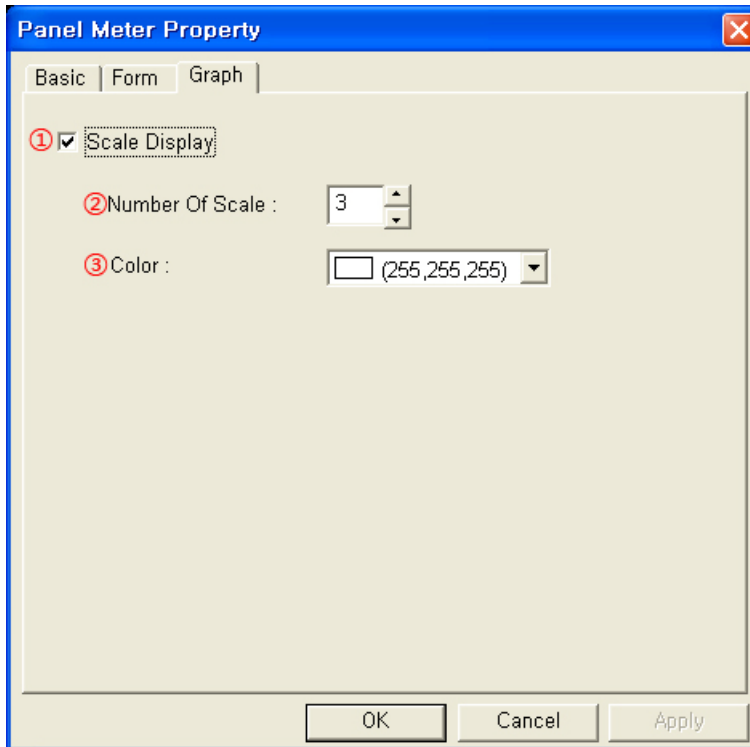

Graph	Description
① Scale Display	Designate using display scale or not.
② Number of Scale	Designate the number of scale.
③ Color	Designate scale color. <ul style="list-style-type: none"> • Mono type(GP-S044, GP-S057, LP-S044): White/Black • Color type(GP-S070, LP-S070): 24bit True Color

5.18 Line Graph

Line graph displays the designated two or more devices value by broken line.

5.18.1 Basic operation

- It displays up to 8 devices with max. 50 points.
- It is able to designate maximum/minimum value of graph, the out of range value is not displayed.
- It is able to designate increased direction (right to left or left to right) of line graph on X axis from lead device.
- According to configuration, it may not display specified value.

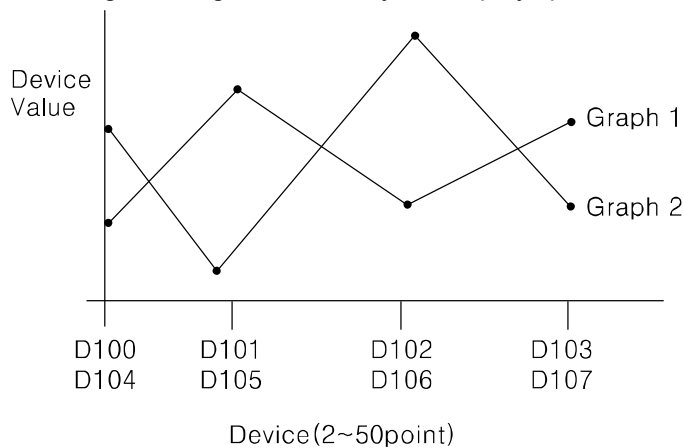

5.18.2 Basic usage

- 1st Select [Draw]-[Line/Trend/Bar] of menu, or click  in toolbar. 'Line/Trend/Bar Property' dialog box appears.
- 2nd Select 'Line' in graph box of 'Basic' tab.
- 3rd Designate the number of graph and the number of point in 'Form' tab.
- 4th Designate device, data type, and graph style, etc in 'Monitor Device' tab.
- 5th Designate maximum/minimum value of graph in 'Display Range' tab.
- 6th Click 'OK' and 'Line/Trend/Bar Property' dialog box is closed. A dotted rectangle follows mouse cursor at edit area.
- 7th Place mouse cursor on the desired area, click left mouse button. Line graph is created on the screen.
- 8th Adjust it to the desired size.



Note

Line graph is the object which can exist only one on a screen and it cannot exist with trend graph on a screen.

5.18.3 Property

5.18.3.1 Basic tab

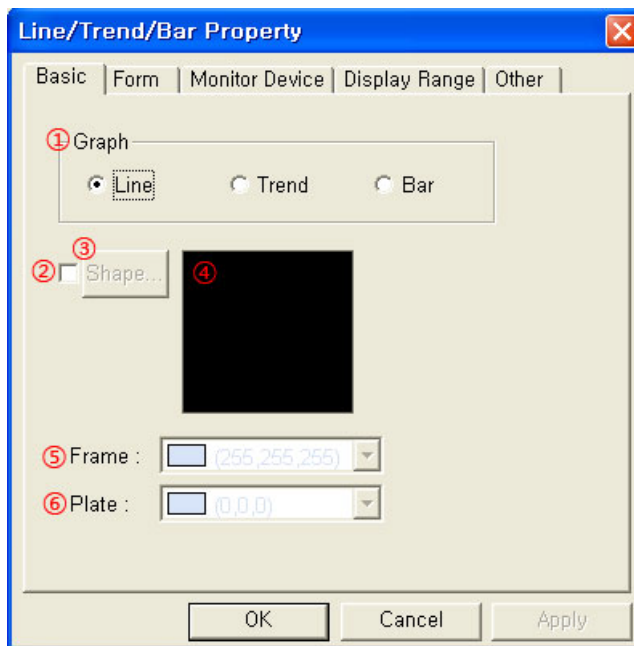

Basic	Description
① Graph	Select graph type. <ul style="list-style-type: none"> Line: Line graph Trend: Trend graph Bar: Bar graph
② Shape	Designate using shape or not. Check this and no. 1 shape is as default.
③ Shape	Activated only with checking ②. Click 'Shape' and 'Image Selection' dialog box appears. Select the desired shape.
④ Shape	Displays the selected shape image
⑤ Frame	Designates frame color. Activated only with checking ②. <ul style="list-style-type: none"> Mono type(GP-S044, GP-S057, LP-S044): White/Black Color type(GP-S070, LP-S070): 24bit True Color
⑥ Plate	Designates plate color. Activated only with checking ②. <ul style="list-style-type: none"> Mono type(GP-S044, GP-S057, LP-S044): White/Black Color type(GP-S070, LP-S070): 24bit True Color

5.18.3.2 Form tab

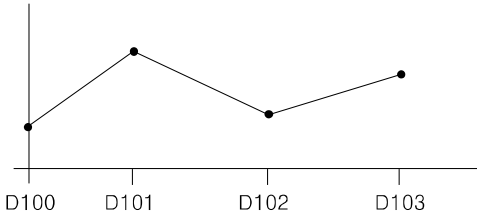
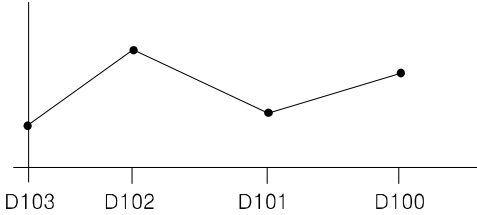
Form	Description
① Direction	<p>Designate increasing direction (right or left) of device address by pull-down menu.</p> <ul style="list-style-type: none"> Right: Device address increases to right direction on X axis.  <ul style="list-style-type: none"> Left: Device address increases to left direction on X axis. 
② Number Of Graph	Designate the number of line on a line graph. Range is 1 to 8.
③ Number Of Point	Designate the number of point on a line up to 50 points. Lead device is designated in 'Monitor device' tab.
④ Display Scale	Not used
⑤ Display Frame	Designate using frame of graph or not.

5.18.3.3 Monitor device tab

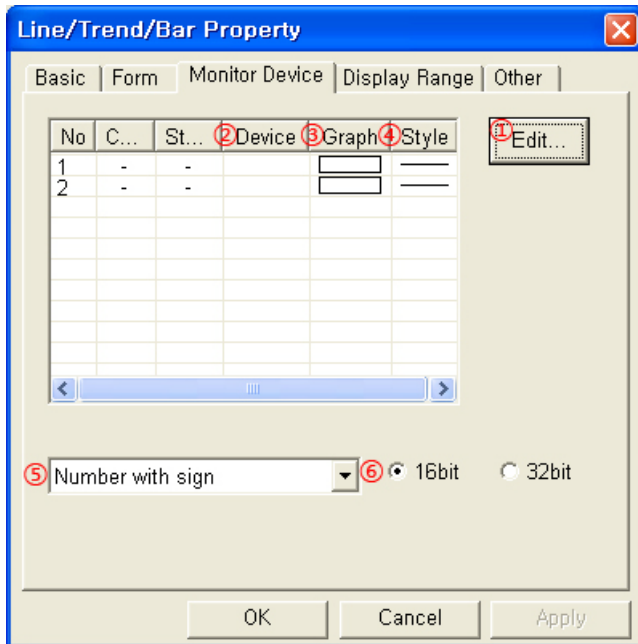

Monitor Device	Description
①Edit	<p>Calls 'Attribute' dialog box. Designate device, color and style of line.</p> <p>①Device: Calls 'Device Select' dialog box. Designate lead device.</p> <p>②Graph: Designate line color.</p> <ul style="list-style-type: none"> • Mono type(GP-S044, GP-S057, LP-S044): White/Black • Color type(GP-S070, LP-S070): 24bit True Color <p>③Style: Designate one line style of solid, dotted, broken, dot chain, two dot chain by pull-down menu.</p>
②Device	Displays lead device of each line.
③Graph	Displays color of each line. Double-click it to edit.
④Style	Displays style of each line. Double-click it to edit.
⑤Data Type	<p>Designate data type of monitor device by pull-down menu.</p> <ul style="list-style-type: none"> • Number with sign: Processes as number with sign reading device • Number without sign: Processes as number without sign reading device

Monitor Device	Description
⑥ Bit	Designate data bit type. <ul style="list-style-type: none"> ▪ 16bit: Single word ▪ 32bit: Double word (Address is assigned by double word unit from lead device)

5.18.3.4 Display range tab

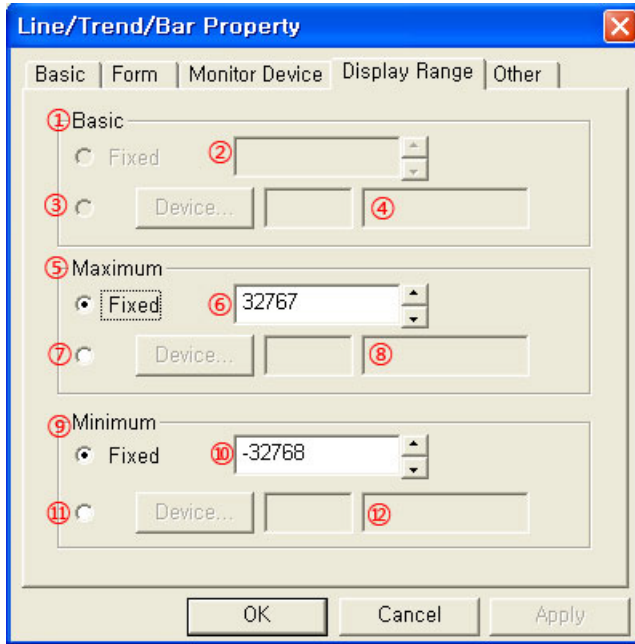

Display Range	Description
① Basic	Not used
② Fixed	
③ Device	
④ Device	
⑤ Fixed	<ul style="list-style-type: none"> ▪ Fixed: Fixed value is maximum value of graph. ▪ Not Fixed: Designated device value of ⑦ is maximum value. If the value is changed, maximum value is also changed.
⑥ Fixed	Designate fixed maximum value.
⑦ Device	Calls 'Device Select' dialog box. Designate maximum device.
⑧ Device	Input device directly or displays the designated device by ⑦
⑨ Minimum	<ul style="list-style-type: none"> ▪ Fixed: Fixed value is minimum value of graph. ▪ Not Fixed: Designated device value of ⑪ is minimum value. If the value is changed, minimum value is also changed.
⑩ Fixed	Designate fixed minimum value.
⑪ Device	Calls 'Device Select' dialog box. Designate minimum device.
⑫ Device	Input device directly or displays the designated device by ⑪.

5.18.3.5 Other tab

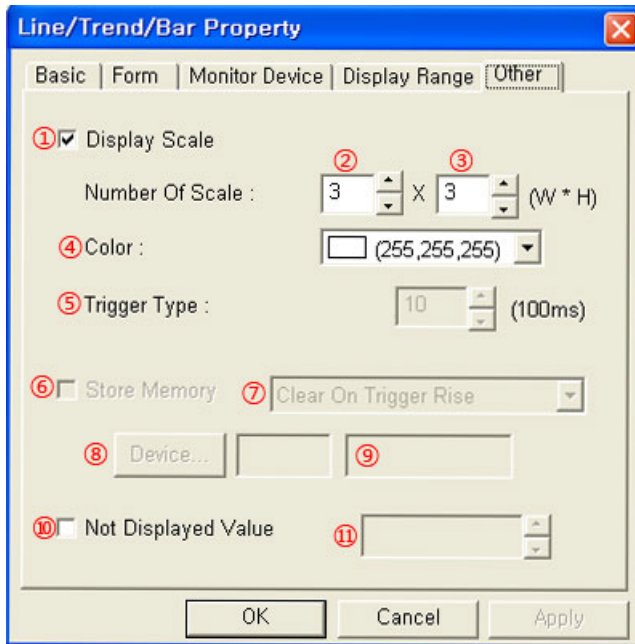

Other	Description
① Display Scale	Designate using display scale or not.
② Number Of Scale (Width)	Designate the number of scale on X axis.
③ Number Of Scale (Height)	Designate the number of scale on Y axis.
④ Color	Designate scale color. <ul style="list-style-type: none"> • Mono type(GP-S044, GP-S057, LP-S044): White/Black • Color type(GP-S070, LP-S070): 24bit True Color
⑤ to ⑨	Not used
⑩ Not Displayed Value	Check not to display the specified value.
⑪ Not Displayed Value	Designate the specified value not to display.
Not Displayed Value function	<p>[If not displayed value is 50.] D101 is 50. The lines between D100 and D101, D101 and D102 are not displayed.</p>

5.19 Trend Graph

Trend graph displays the designated devices according to time by broken line.

5.19.1 Basic operation

- X axis is time, Y axis is device value.
- It is able to designate maximum/minimum value of graph, the out of range value is not displayed.
- It displays up to 8 devices with max. 50 points.
- It is able to designated sampling period by 100ms unit from 100ms to 3600s.
- It is able to designate time increased direction.
- Even if the other screen is switched by configuration, it continues to sampling and saves sample data to GP/LP inner memory. When returning to the designated screen, trend graph displays trends with history using that data.

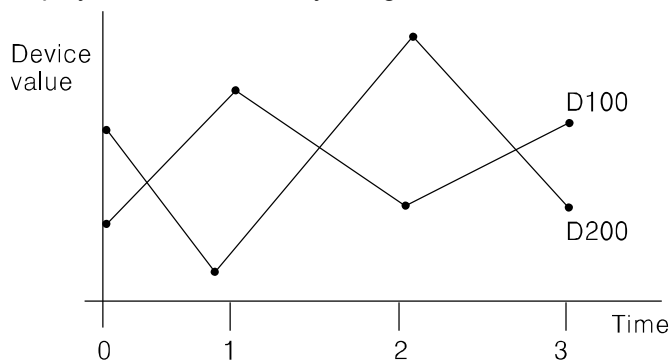

5.19.2 Basic usage

- 1st Select [Draw]-[Line/Trend/Bar] of menu, or click  in toolbar. 'Line/Trend/Bar Property' dialog box appears.
- 2nd Select 'Trend' in graph box of 'Basic' tab.
- 3rd Designate the number of graph and the number of point in 'Form' tab.
- 4th Designate device, data type, and graph stype, etc in 'Monitor Device' tab.
- 5th Designate maximum/minimum value of graph in 'Display Range' tab.
- 6th Click 'OK' and 'Line/Trend/Bar Property' dialog box is closed. A dotted rectangle follows mouse cursor at edit area.
- 7th Place mouse cursor on the desired area, click left mouse button. Trend graph is created on the screen.
- 8th Adjust it to the desired size.



Note

Trend graph is the object which can exist only one on a screen and it cannot exist with line graph on a screen.

5.19.3 Property

5.19.3.1 Basic tab

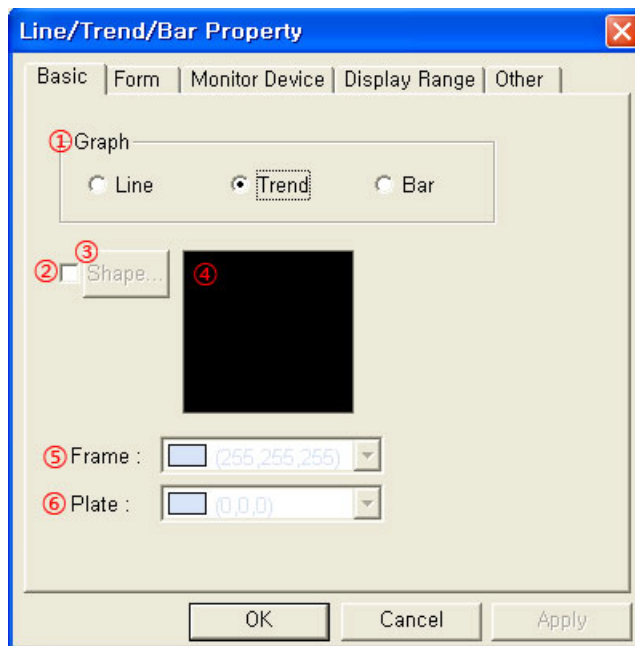

Basic	Description
① Graph	Select graph type. <ul style="list-style-type: none"> Line: Line graph Trend: Trend graph Bar: Bar graph
② Shape	Designate using shape or not. Check this and no. 1 shape is as default.
③ Shape	Activated only with checking ②. Click 'Shape' and 'Image Selection' dialog box appears. Select the desired shape.
④ Shape	Displays the selected shape image.
⑤ Frame	Designates frame color. Activated only with checking ②. <ul style="list-style-type: none"> Mono type(GP-S044, GP-S057, LP-S044): White/Black Color type(GP-S070, LP-S070): 24bit True Color
⑥ Plate	Designates plate color. Activated only with checking ②. <ul style="list-style-type: none"> Mono type(GP-S044, GP-S057, LP-S044): White/Black Color type(GP-S070, LP-S070): 24bit True Color

5.19.3.2 Form tab

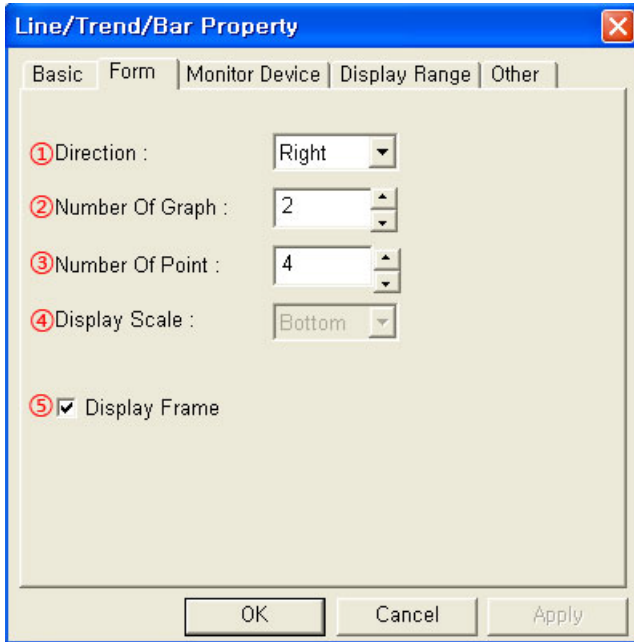

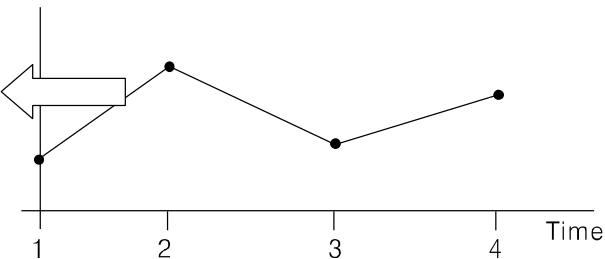
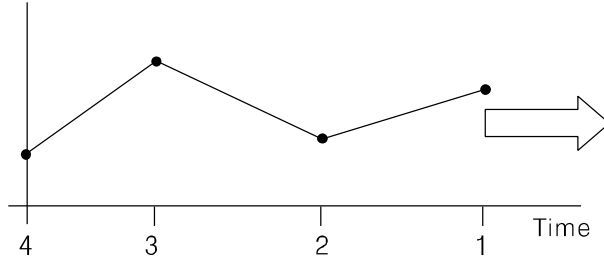
Form	Description
<p>① Direction</p>	<p>Designate time increasing direction (right or left) on X axis by pull-down menu.</p> <ul style="list-style-type: none"> Right: Time increases to right direction on X axis. Graph follows left direction. The most right point is the latest sample.  <ul style="list-style-type: none"> Left: Time increases to left direction on X axis. Graph follows right direction. The most left point is the latest sample. 
<p>② Number Of Graph</p>	<p>Designate the number of line on a trend graph. Range is 1 to 8.</p>

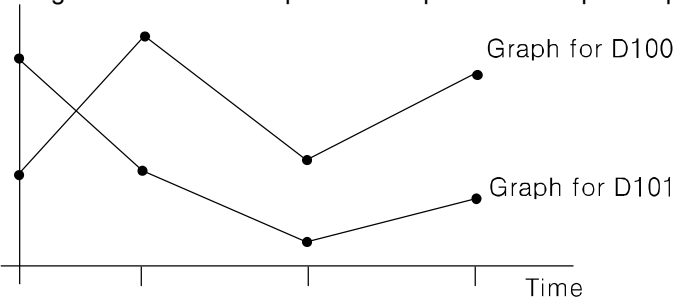
Form	Description
<p>③Number Of Point</p>	<p>Designate the number of point of sample on a line up to 50 points.</p>  <p>The above example is for trend graph when number of graph=2, number of point =4, lead device is D100. There are two lines and 4 samples because number of graph is 2 and number of point is 4. Lead device is designated in 'Monitor device' tab.</p>
<p>④Display Scale</p>	<p>Not used</p>
<p>⑤Display Frame</p>	<p>Designate using frame of graph or not.</p>

5.19.3.3 Monitor device tab

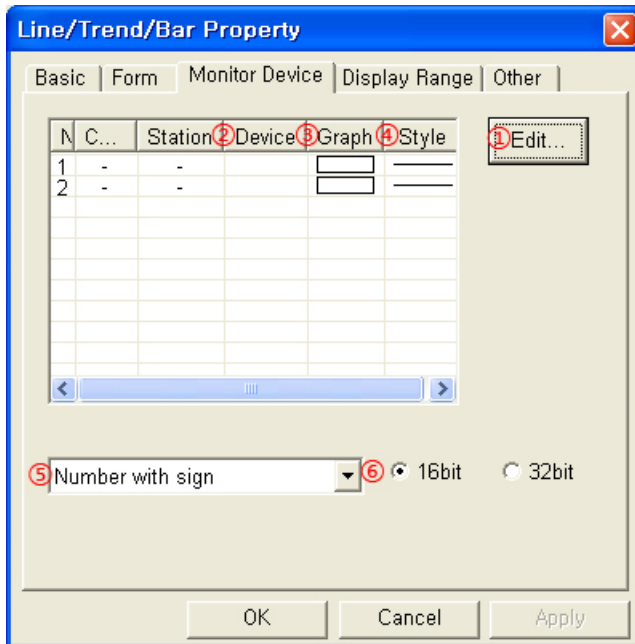

Monitor Device	Description
① Edit	<p>Calls 'Attribute' dialog box. Designate device, color and style of line.</p>  <p>① Graph: Designate line color.</p> <ul style="list-style-type: none"> • Mono type(GP-S044, GP-S057, LP-S044): White/Black • Color type(GP-S070, LP-S070): 24bit True Color <p>② Style: Designate one line style of solid, dotted, broken, dot chain, two dot chain by pull-down menu.</p> <p>③ Device: Calls 'Device Select' dialog box. Designate lead device.</p>
② Device	Displays lead device of each line.
③ Graph	Displays color of each line. Double-click it to edit.
④ Style	Displays style of each line. Double-click it to edit.
⑤ Data Type	<p>Designate data type of monitor device by pull-down menu.</p> <ul style="list-style-type: none"> • Number with sign: Processes as number with sign reading device • Number without sign: Processes as number without sign reading device
⑥ Bit	<p>Designate data bit type.</p> <ul style="list-style-type: none"> • 16bit: Single word • 32bit: Double word <p>Depending on connected device type, it may use only 32bit. Refer to 'GP,LP user manual for communication'.</p>

5.19.3.4 Display range tab

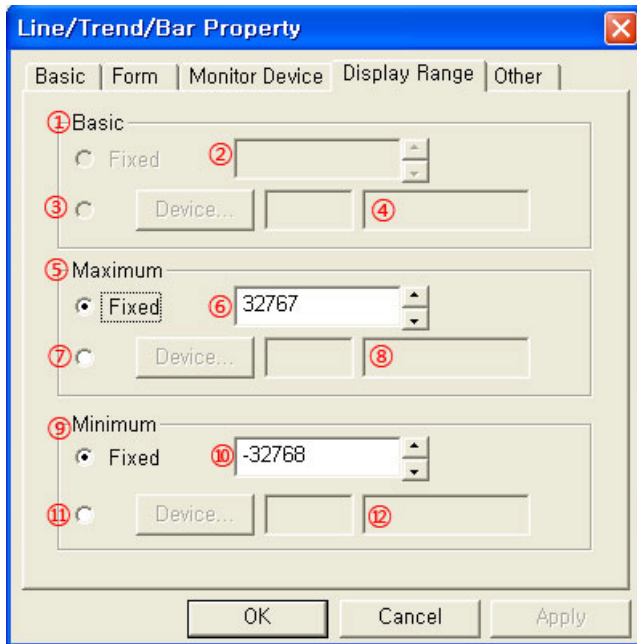

Display Range	Description
① Basic	Not used
② Fixed	
③ Device	
④ Device	
⑤ Maximum	<ul style="list-style-type: none"> Fixed: Fixed value is maximum value of graph. Not Fixed: Designated device value of ⑦ is maximum value. If the value is changed, maximum value is also changed.
⑥ Fixed	Designate fixed maximum value.
⑦ Device	Calls 'Device Select' dialog box. Designate maximum device.
⑧ Device	Input device directly or displays the designated device by ⑦
⑨ Minimum	<ul style="list-style-type: none"> Fixed: Fixed value is minimum value of graph. Not Fixed: Designated device value of ⑪ is minimum value. If the value is changed, minimum value is also changed.
⑩ Fixed	Designate fixed minimum value.
⑪ Device	Calls 'Device Select' dialog box. Designate minimum device.
⑫ Device	Input device directly or displays the designated device by ⑪.

5.19.3.5 Other tab

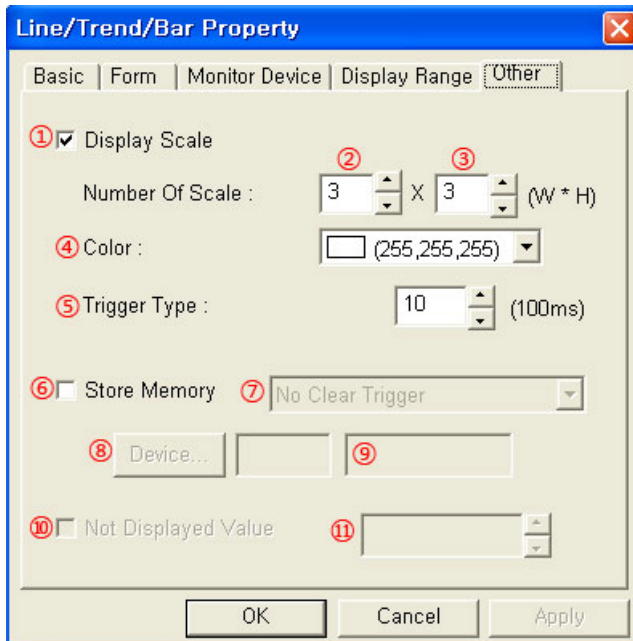

Other	Description
① Display Scale	Designate using display scale on X axis and Y axis or not.
②, ③ Number Of Scale	Designate the number of scale on X axis and Y axis.
④ Color	Designate scale color. <ul style="list-style-type: none"> • Mono type(GP-S044, GP-S057, LP-S044): White/Black • Color type(GP-S070, LP-S070): 24bit True Color
⑤ Trigger Type	Designate sampling period by 100ms unit from 100ms to 3600s.
⑥ Store Memory	<ul style="list-style-type: none"> • Non-checking this, when the screen returns from another screen, it does not save history and draws from the first again. • Checking this, it does sampling continuously with saving history at GP/LP inner memory when the screen switches to another screen. Returning to the screen which has trend graph, it displays graph with the saved data. Even though editing another screen, it seems drawing graph continuously. • Store memory option is also for 'alarm list'. You can designate this option only up to 17.
⑦ Store Memory	For store memory function, initializes GP/LP memory. <ul style="list-style-type: none"> • No Clear Trigger: Not initialize GP/LP inner memory for the specified trend graph • Clear On Trigger Rise: Makes ⑧ Device to activate. Designate bit device to initialize GP/LP inner memory for the specified trend graph at rising edge of the device • Clear On Trigger Fall: Initializes GP/LP inner memory for the specified trend graph at falling edge of the trigger device
⑧ Device	Activated only with checking ⑥ Store Memory and when ⑦ Store Memory is 'Clear On Trigger Rise' or 'Clear On Trigger Fall'. Calls 'Device Select' dialog box, and designate trigger device.

Other	Description
⑨ Device	Input device directly or displays the designated trigger device.
⑩, ⑪ Not Displayed Value	Not used

5.20 Bar Graph

Bar graph displays the designated device value by bar.

5.20.1 Basic operation

- It displays the value from reference value to current device value with designated maximum/minimum/reference value by bar.
- Minimum size is 16x16 dots.
- It displays reference point to be reversed at 3 dots from the opposite of start scale.
- It displays a oblique line when device value is out of the maximum/minimum range.

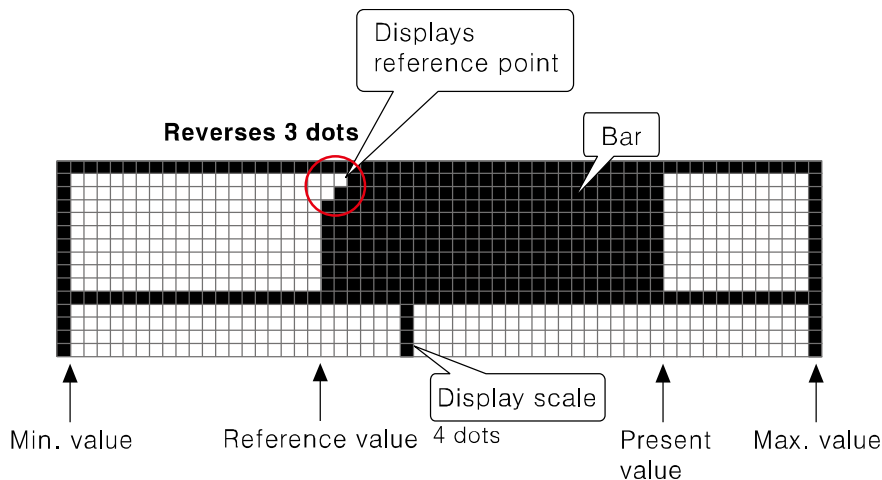

5.20.2 Basic usage

- 1st Select [Draw]-[Line/Trend/Bar] of menu, or click  in toolbar. 'Line/Trend/Bar Property' dialog box appears.
- 2nd Select 'Bar' in graph box of 'Basic' tab.
- 3rd Designate graph direction in 'Form' tab.
- 4th Designate monitor device and data type in 'Monitor Device' tab.
- 5th Designate basic, maximum/minimum value of graph in 'Display Range' tab.
- 6th Click 'OK' and 'Line/Trend/Bar Property' dialog box is closed. A dotted rectangle follows mouse cursor at edit area.
- 7th Place mouse cursor on the desired area, click left mouse button. Bar graph is created on the screen.
- 8th Adjust it to the desired size.

5.20.3 Property

5.20.3.1 Basic tab

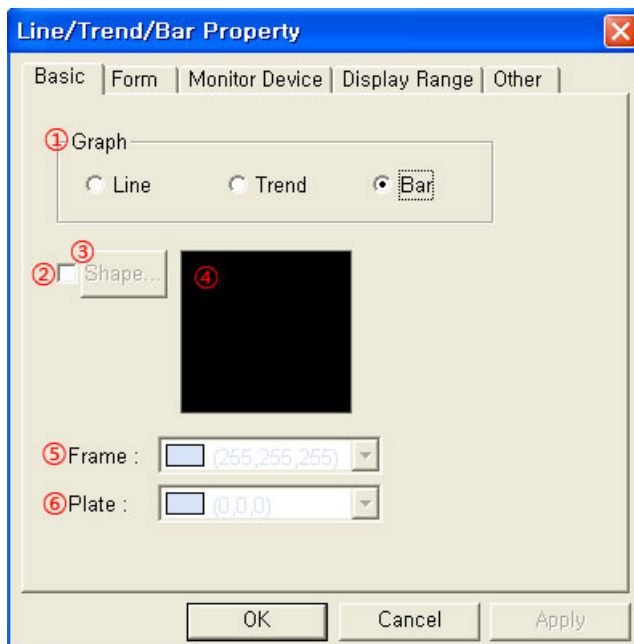

Basic	Description
①Graph	Select graph type. <ul style="list-style-type: none"> Line: Line graph Trend: Trend graph Bar: Bar graph
②Shape	Designate using shape or not. Check this and no. 1 shape is as default.
③Shape	Activated only with checking ②. Click 'Shape' and 'Image Selection' dialog box appears. Select the desired shape.
④Shape	Displays the selected shape image
⑤Frame	Designates frame color. Activated only with checking ②. <ul style="list-style-type: none"> Mono type(GP-S044, GP-S057, LP-S044): White/Black Color type(GP-S070, LP-S070): 24bit True Color
⑥Plate	Designates plate color. Activated only with checking ②. <ul style="list-style-type: none"> Mono type(GP-S044, GP-S057, LP-S044): White/Black Color type(GP-S070, LP-S070): 24bit True Color

5.20.3.2 Form tab

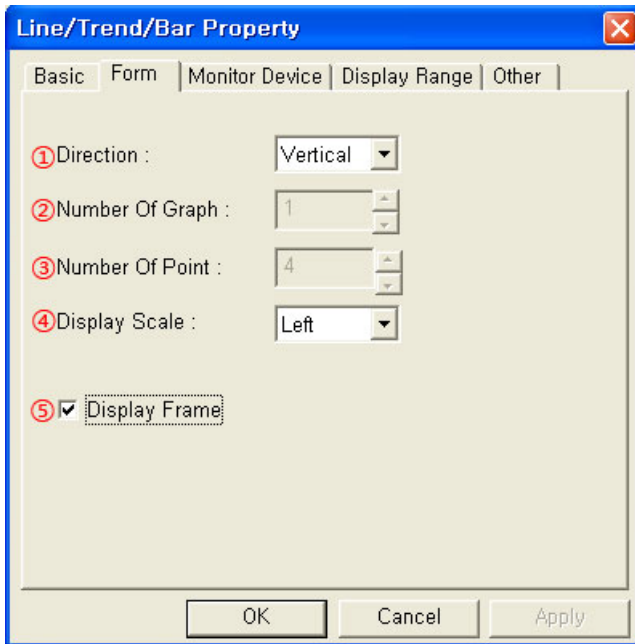

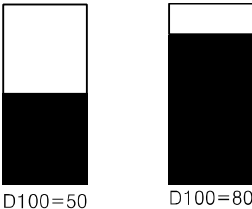
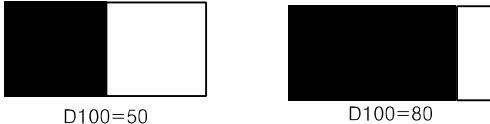
Form	Description
① Direction	<p>Designate bar graph direction (vertical or horizontal) by pull-down menu.</p> <ul style="list-style-type: none"> Vertical: Bar increases to vertical direction.  <p>The above shape examples are, when monitor device is D100 and direction is vertical, that D100 is 50, D100 is 80.</p> <ul style="list-style-type: none"> Horizontal: Bar increases to horizontal direction.  <p>The above shape examples are, when monitor device is D100 and direction is horizontal, that D100 is 50, D100 is 80.</p>
② Number Of Graph	Not used
③ Number Of Point	
④ Display Scale	<p>Designate scale direction by pull-down menu.</p> <ul style="list-style-type: none"> Select right or left direction when ① Direction is vertical. Displays scale at right/left frame. Select top or bottom direction when ① Direction is horizontal. Displays scale at top/left frame.
⑤ Display Frame	Designate using frame of graph or not.

5.20.3.3 Monitor device tab

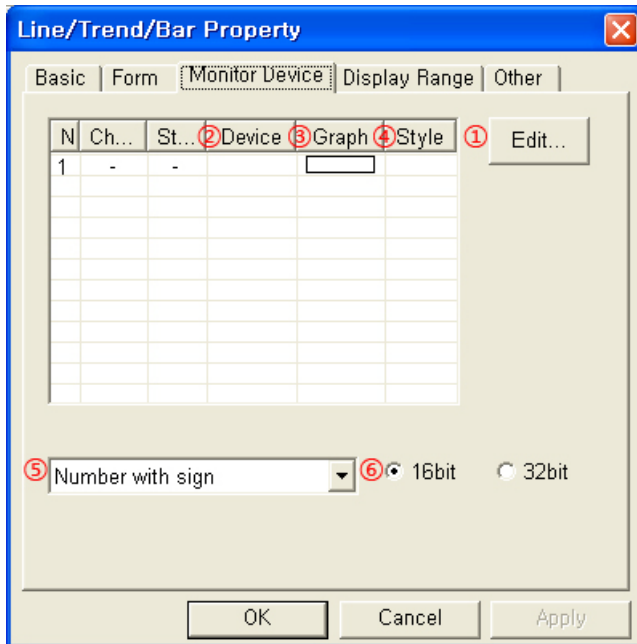

Monitor Device	Description
①Edit	<p>Calls 'Attribute' dialog box. Designate device, color of bar.</p> <p>①Graph: Designate bar color.</p> <ul style="list-style-type: none"> • Mono type(GP-S044, GP-S057, LP-S044): White/Black • Color type(GP-S070, LP-S070): 24bit True Color <p>②Device: Calls 'Device Select' dialog box. Designate monitor device.</p>
②Device	Displays device of each bar.
③Graph	<p>Displays color of each bar.</p> <ul style="list-style-type: none"> • Mono type(GP-S044, GP-S057, LP-S044): White/Black • Color type(GP-S070, LP-S070): 24bit True Color
④Style	Not used
⑤Data Type	<p>Designate data type of monitor device by pull-down menu.</p> <ul style="list-style-type: none"> • Number with sign: Processes as number with sign reading device • Number without sign: Processes as number without sign reading device
⑥Bit	<p>Designate data bit type.</p> <ul style="list-style-type: none"> • 16bit: Single word • 32bit: Double word

5.20.3.4 Display range tab

The screenshot shows the 'Line/Trend/Bar Property' dialog box with the 'Display Range' tab selected. The dialog is divided into three main sections: 'Basic', 'Maximum', and 'Minimum'. Each section contains a radio button for 'Fixed' and a 'Device...' button. The 'Basic' section has a value of 0. The 'Maximum' section has a value of 32767. The 'Minimum' section has a value of -32768. Red circled numbers 1 through 12 are overlaid on the dialog to indicate specific UI elements.

Display Range	Description
① to ④ Basic	Designate reference value. <ul style="list-style-type: none"> Fixed: Fixed value is reference value of bar graph. Not Fixed: Designated device value of ③ is reference value.
⑤ to ⑧ Maximum	Designate maximum value.
⑨ to ⑫ Minimum	Designate minimum value.

5.20.3.5 Other tab

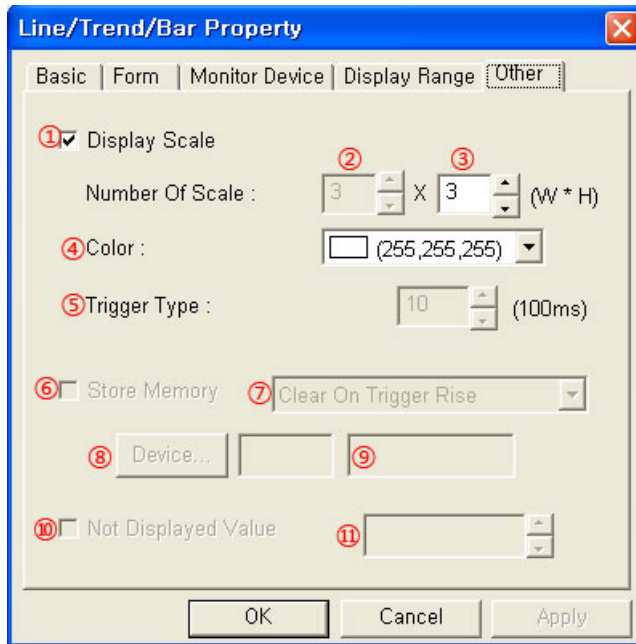

Other	Description
① Display Scale	Designate using display scale or not.
② Number Of Scale (Width)	Activated only with when direction is 'Horizontal' in 'Form' tab. Designate the number of scale on bar graph.
③ Number Of Scale (Height)	Activated only with when direction is 'Vertical' in 'Form' tab. Designate the number of scale on bar graph.
④ Color	Designate scale color. <ul style="list-style-type: none"> ▪ Mono type(GP-S044, GP-S057, LP-S044): White/Black ▪ Color type(GP-S070, LP-S070): 24bit True Color
⑤ to ⑫	Not used

5.21 Statistics Graph

Statistics graph displays more than 2 of value with that ratio.

It is able to display with rectangle or circle graph according to configuration. The statistics graph is sum total from absolute value of the designated word device. Each graph area of the devices is same ratio of absolute value of the each device. It displays from 2 to 8 devices.

5.21.1 Basic operation

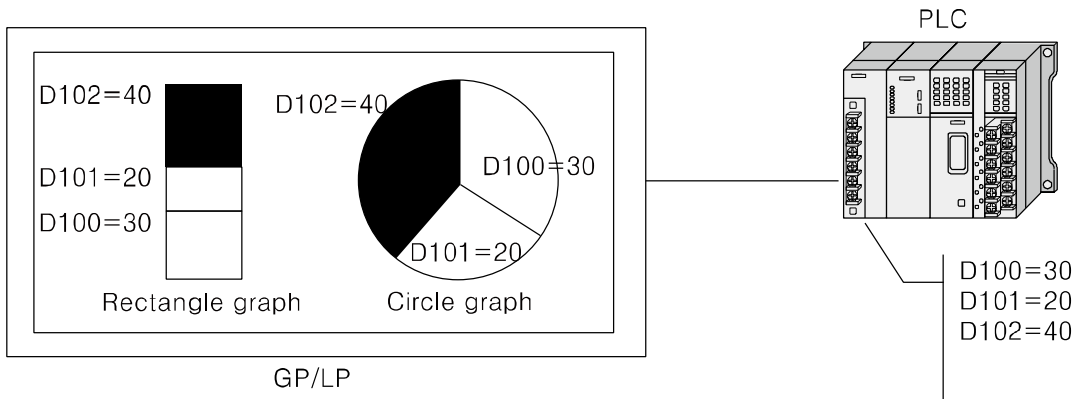

The above figure is rectangle and circle type of statistics graph according to device value when monitor device is D100, D101, and D102. If D100 is 30, D101 is 20, D102 is 40, the each area of devices is displayed with the ratio of 30:20:40.

It is able to designate reference direction as top or right for rectangle type of statistics graph. In case of top direction, the area of from lead device is displayed with from bottom to top direction. In case of right direction, the area of from lead device is displayed with from left to right direction.

For circle type of statistics graph, the areas of each device have equal radius. Based on the 12 o'clock position, the circle graph displays the sum total of all devices with each ratio to clockwise direction.



5.21.2 Basic usage

- 1st Select [Draw]-[Statistics Graph] of menu, or click  in toolbar. 'Statistics Property' dialog box appears.
- 2nd Select graph type (rectangle or circle) and designate the number of partition in 'Basic' tab.
- 3rd Designate monitor device and color of each partition, data type in 'Division' tab.
- 4th Click 'OK' and 'Statistics Property' dialog box is closed. A dotted rectangle follows mouse cursor at edit area.
- 5th Place mouse cursor on the desired area, click left mouse button. Statistics graph is created on the screen.
- 6th Adjust it to the desired size.

5.21.3 Property

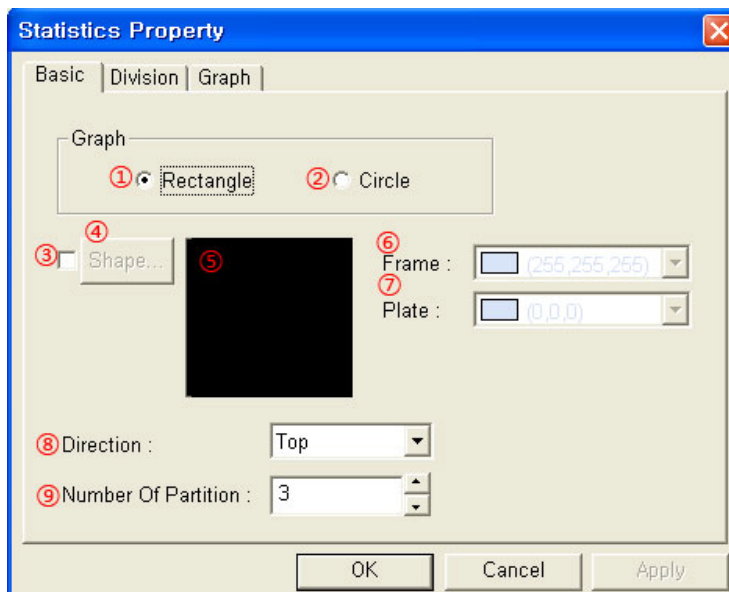
5.21.3.1 Basic tab

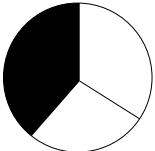

Basic	Description
①Rectangle	Designate rectangle type graph. 
②Circle	Designate circle type graph. 
③ to ⑤ Shape	Designate shape.
⑥Frame	Designates frame color. Activated only with checking ③. <ul style="list-style-type: none"> ▪ Mono type(GP-S044, GP-S057, LP-S044): White/Black ▪ Color type(GP-S070, LP-S070): 24bit True Color
⑦Plate	Designates plate color. Activated only with checking ③. <ul style="list-style-type: none"> ▪ Mono type(GP-S044, GP-S057, LP-S044): White/Black ▪ Color type(GP-S070, LP-S070): 24bit True Color
⑧Direction	Activated only with checking ①Rectangle. Designate direction as top or right for rectangle graph by pull-down menu.   Direction: Top Direction: Right <ul style="list-style-type: none"> ▪ Top: Places low address device on bottom partition. ▪ Right: Places low address device on left partition.
⑨Number of Partition	Designate number of partition for graph. One partition is for one device, it is same as designation of device point to be used on statistics graph.

5.21.3.2 Division tab

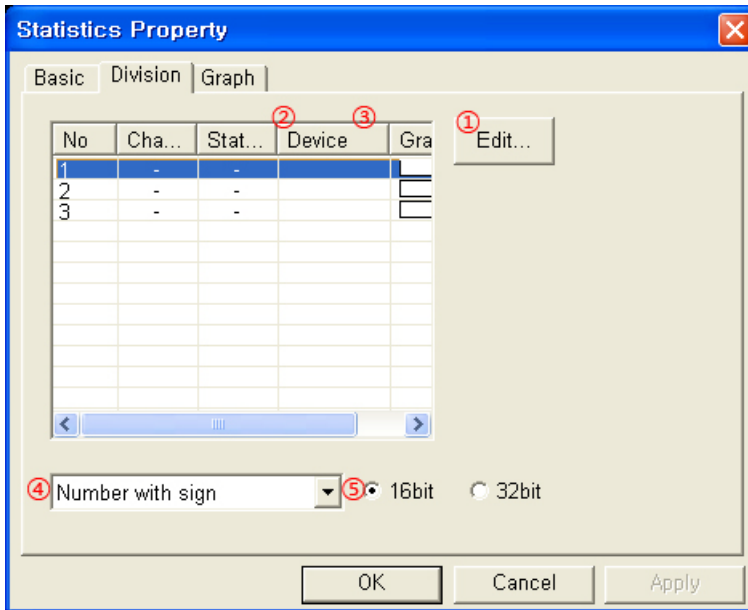

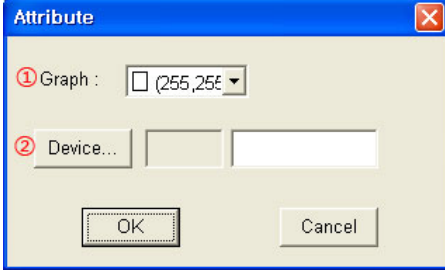
Division	Description
① Edit	<p>'Calls 'Attribute' dialog box. Designate device, color of partition.</p>  <p>① Graph: Designate partition color.</p> <ul style="list-style-type: none"> ▪ Mono type(GP-S044, GP-S057, LP-S044): White/Black ▪ Color type(GP-S070, LP-S070): 24bit True Color <p>② Device: Calls 'Device Select' dialog box. Designate monitor device.</p>
② Device	Displays device of each partition.
③ Graph	Displays color of each partition.
④ Data Type	<p>Designate data type of monitor device by pull-down menu.</p> <ul style="list-style-type: none"> ▪ Number with sign: Processes as number with sign reading device ▪ Number without sign: Processes as number without sign reading device
⑤ Bit	<p>Designate data bit type.</p> <ul style="list-style-type: none"> ▪ 16bit: Single word ▪ 32bit: Double word ▪ If ④ Data Type is 'Number with sign', it calculates ratio changing the reference value to absolute value.

5.21.3.3 Graph tab

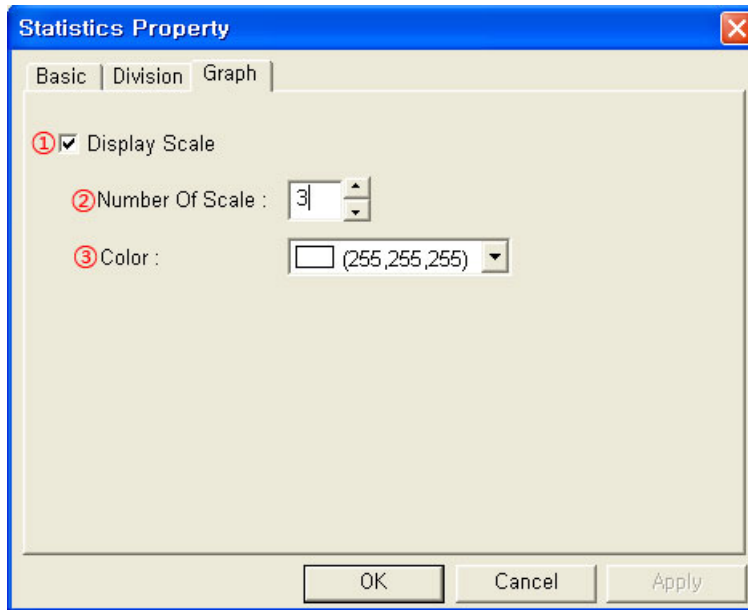

Graph	Description
① Display Scale	<p>Designate using display scale or not. Scale direction is different with the designation of graph type (rectangle or circle) in 'Basic' tab.</p> <ul style="list-style-type: none"> In case of rectangle type, <ul style="list-style-type: none"> When 'Direction' is 'Right' in 'Basic' tab, scale is displayed on bottom. When 'Direction' is 'Top' in 'Basic' tab, scale is displayed on left. In case of circle type, <ul style="list-style-type: none"> Based on the 12 o'clock position, scale is displayed with regular intervals for the designated number of scale on circle circumference.
② Number Of Scale	Designate the number of scale from 2 to 50.
③ Color	<p>Designate scale and outline color.</p> <ul style="list-style-type: none"> Mono type(GP-S044, GP-S057, LP-S044): White/Black Color type(GP-S070, LP-S070): 24bit True Color

5.22 Touch Key

Touch key executes the defined operation such as bit/word device designation, screen switching, specified function with key code when touching screen area of tag arranged.

5.22.1 Basic operation

5.22.1.1 Setting of bit device

Controls ON/OFF state of PLC bit device with touch.

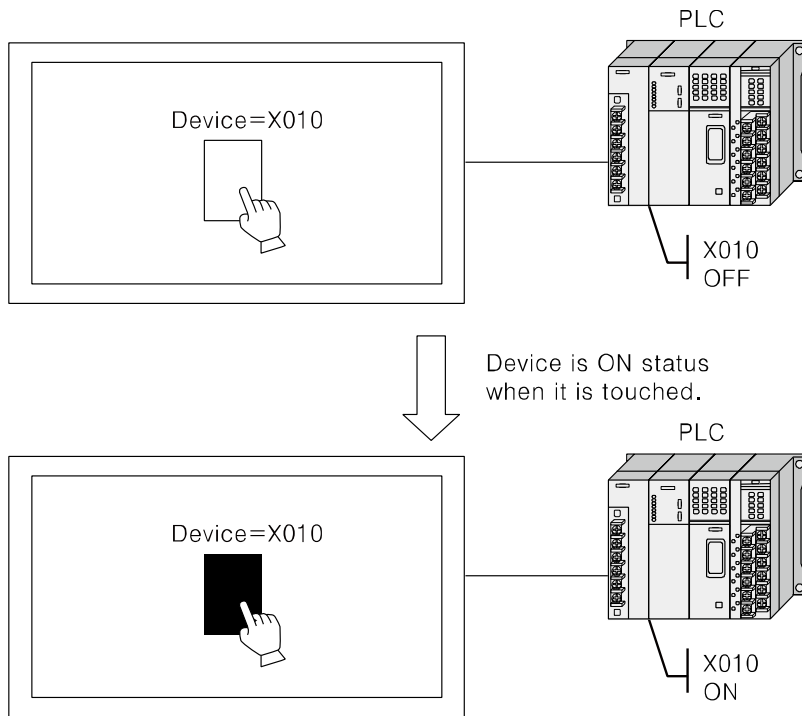

Example of Set operation

[Action mode]

- Set: Turns ON the designated device when touching.
- Reset: Turns OFF the designated device when touching.
- Alternate: Alternates the current state of designated device when touching.
- Momentary: Maintains momentary ON the designated device only when touching.

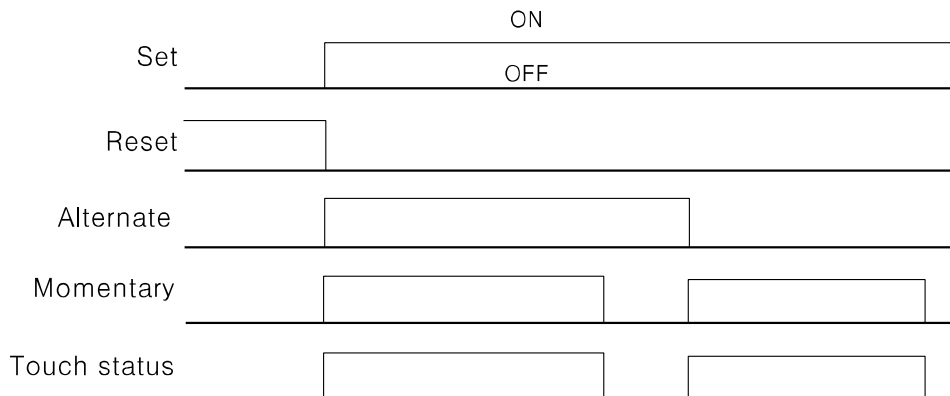

5.22.1.2 Setting of word device

Saves value to word device with touching tag.

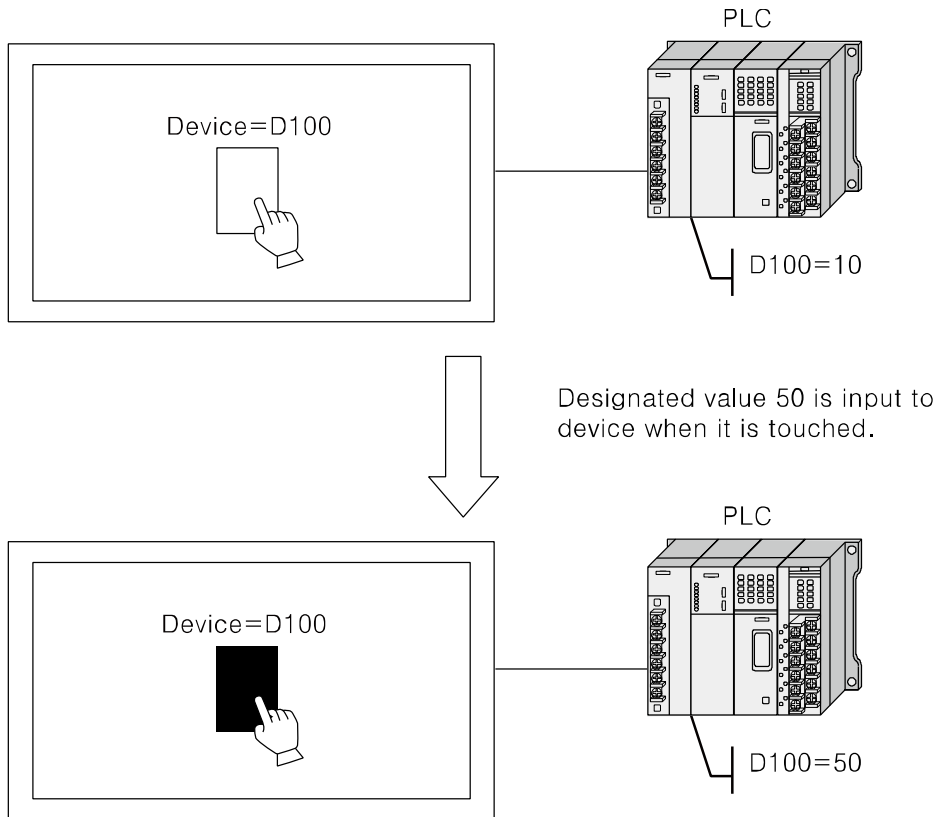

Example of word operation: Designated value 50 is input to D100.

- It is able to designate 16bit or 32bit word device.
- It is able to designate indirectly to be changed device value to the designated word device by fixed value or adding up fixed value and user-defined device value.
- It is able to reset device value.

5.22.1.3 Switching screen

Switches screen with touching tag.

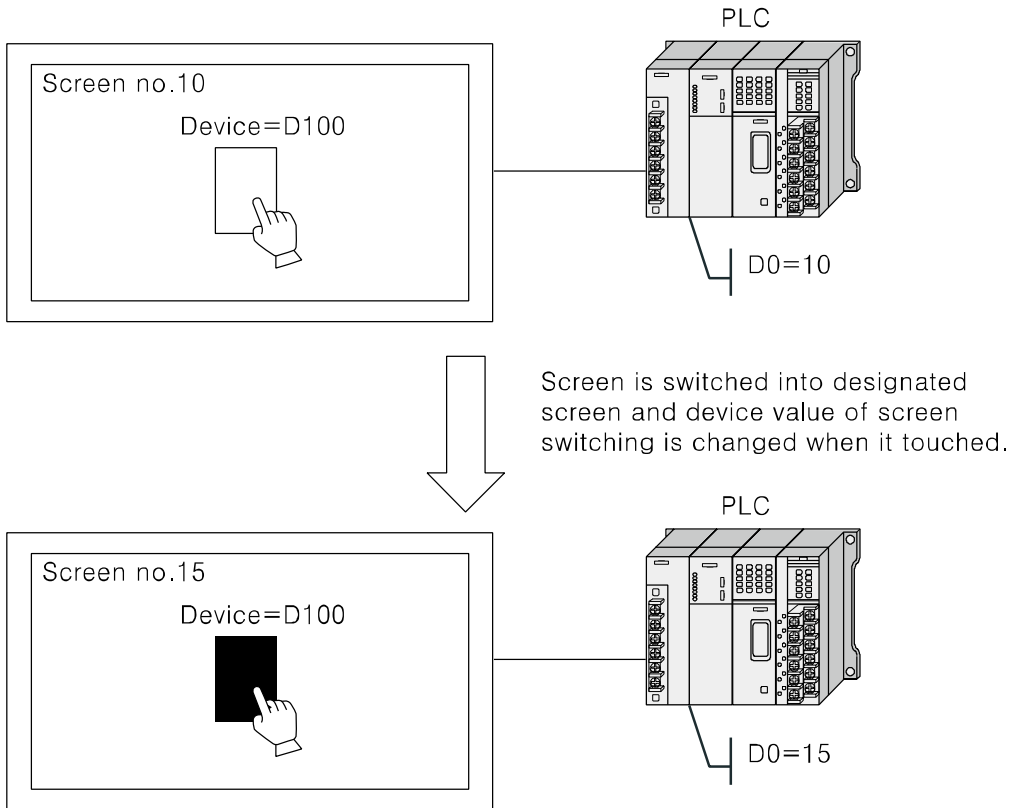

Example of screen switching operation : When device of screen switching is D0.

There are four action mode for switching screen.

- ① +1: Moves from current screen to one more number screen
- ② -1: Moves from current screen number to one less number screen
- ③ Previous Screen: Moves to previous screen before switching
- ④ Fixed: Moves to the designated screen

It changes saving device value of base number displaying on GP/LP with touch operation. Simultaneously, it is switched as base screen of configuration number with screen designated. Only one operation is executed for one touch key.

5.22.1.4 Specified function with key code

There are two specified touch functions with key code; ASCII key code, function key code. ASCII key code is for user-defined key window to input numeral/ASCII at Numeral Input/ASCII Input. Function key code is for adjust alarm list, alarm history, security function.

For further details are as below.

Key code (Hexadecimal)	Function	Description
FFA1	Clear(CLR)	Clears up to current input in key window
FFA2	Enter (ENT)	Completes to input in key window
FFA3	Backspace(BS)	Deletes the last input character in key window
FFA4	Show cursor	Shows cursor in alarm list/alarm history
FFA5	Hide cursor	Hides cursor in alarm list/alarm history
FFA6	Detailed alarm information	Calls detail screen in alarm list/alarm history
FFA7	Call window for password input	Calls key window for password input
FFA8	Erase selected alarm	Deletes selected alarm in alarm history
FFA9	Erase all alarm	Deletes all restored alarms in alarm history
FFAA	Reset alarm device	Resets selected alarm device in alarm history
FFAB	Move cursor upward	Moves cursor to upward in alarm list/alarm history
FFAC	Move cursor downward	Moves cursor to downward in alarm list/alarm history
FFAD	Lock security	Resets security



Note

Bit/Word action, screen switching functions are designated dually at one touch key. Base switching function is designated at only one touch key.

Processing priority of one touch key action is word setting, bit momentary, bit set, bit reset, bit alternate, screen switching. If two or more same actions are designated, first designated action is processed.

5.22.2 Basic usage

- 1st Select [Draw]-[Touch Key] of menu, or click  in toolbar. 'Touchkey Property' dialog box appears.
- 2nd Designate display trigger and touch key shape in 'Basic' tab.
- 3rd Designate shape and text in 'Form' tab.
- 4th Designate bit action, word action, and switching screen, etc. in 'Action' tab.
- 5th Click 'OK' and 'Touchkey Property' dialog box is closed. A dotted rectangle follows mouse cursor at edit area.
- 6th Place mouse cursor on the desired area, click left mouse button. Touch key is created on the screen.



Note

Touch recognition range is 16X20 dot size. Mesh of GP Editor is same as one touch switch. Draw touch key for mesh, it prohibits from activating another adjacent touch key.

5.22.3 Property

5.22.3.1 Basic tab

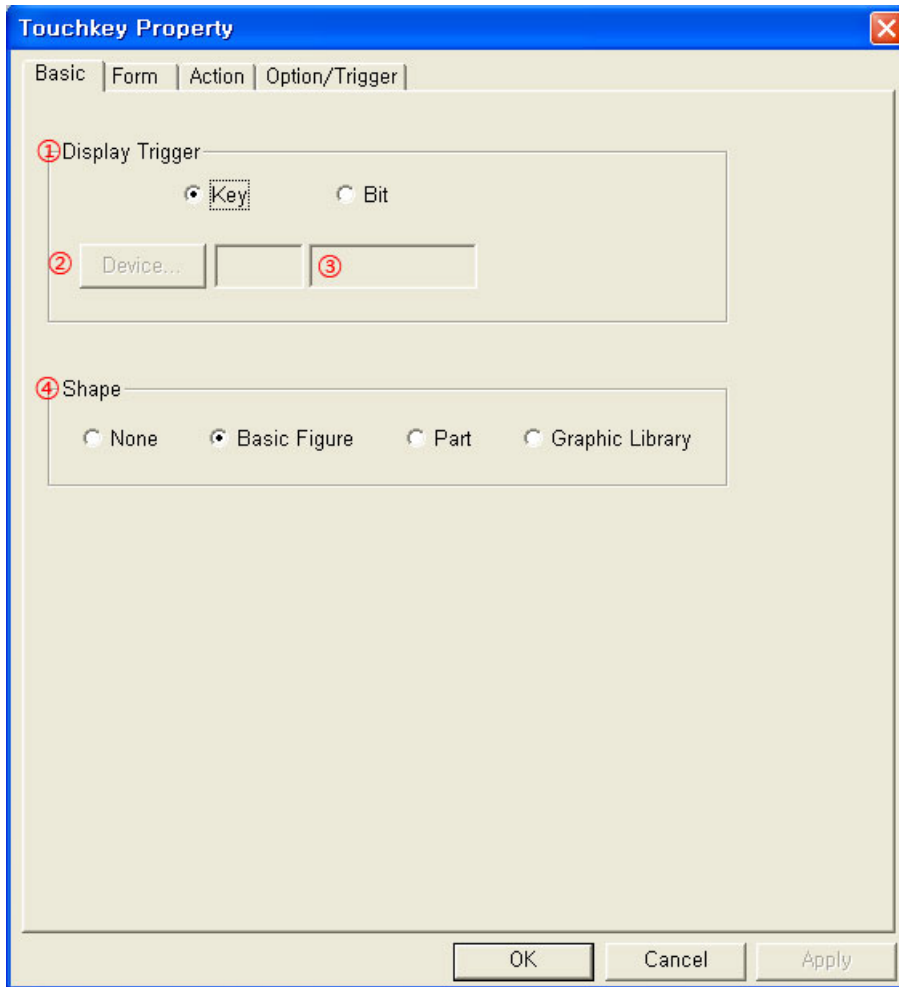

Basic	Description
<p>① Display Trigger</p>	<p>Designate switching condition of touch key shape for ON/OFF.</p> <ul style="list-style-type: none"> Key: Displays ON shape with maintaining touch. <div style="text-align: center;"> </div>

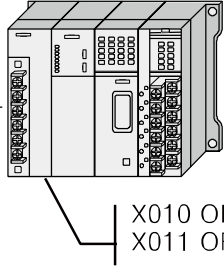
Basic	Description
<p>① Display Trigger</p>	<ul style="list-style-type: none"> Bit: Depending on ON/OFF state of trigger device(designated at ②), displays ON/OFF shape. ON/OFF state of the device and touch key is not related. <div style="display: flex; align-items: center; justify-content: space-around;"> <div data-bbox="491 353 994 589" style="border: 1px solid black; padding: 10px; text-align: center;"> <p>Display trigger=Bit</p>  </div> <div data-bbox="1002 331 1425 633" style="text-align: center;"> <p>PLC</p>  </div> </div> <p>Irrelevant to this designation, the designated key function in 'Action' tab executes when touching.</p>
<p>② Device</p>	<p>Calls 'Device Select' dialog box and designate trigger device.</p>
<p>③ Device</p>	<p>Input device directly or displays the designated device by ②</p>
<p>④ Shape</p>	<ul style="list-style-type: none"> None: Displays outlines of touch area Basic Figure: Uses black/white image supplied by GP Editor. Part: Uses user-defined part Graphic Library: Uses bitmap image supplied by GP Editor and user-defined image

5.22.3.2 Form tab

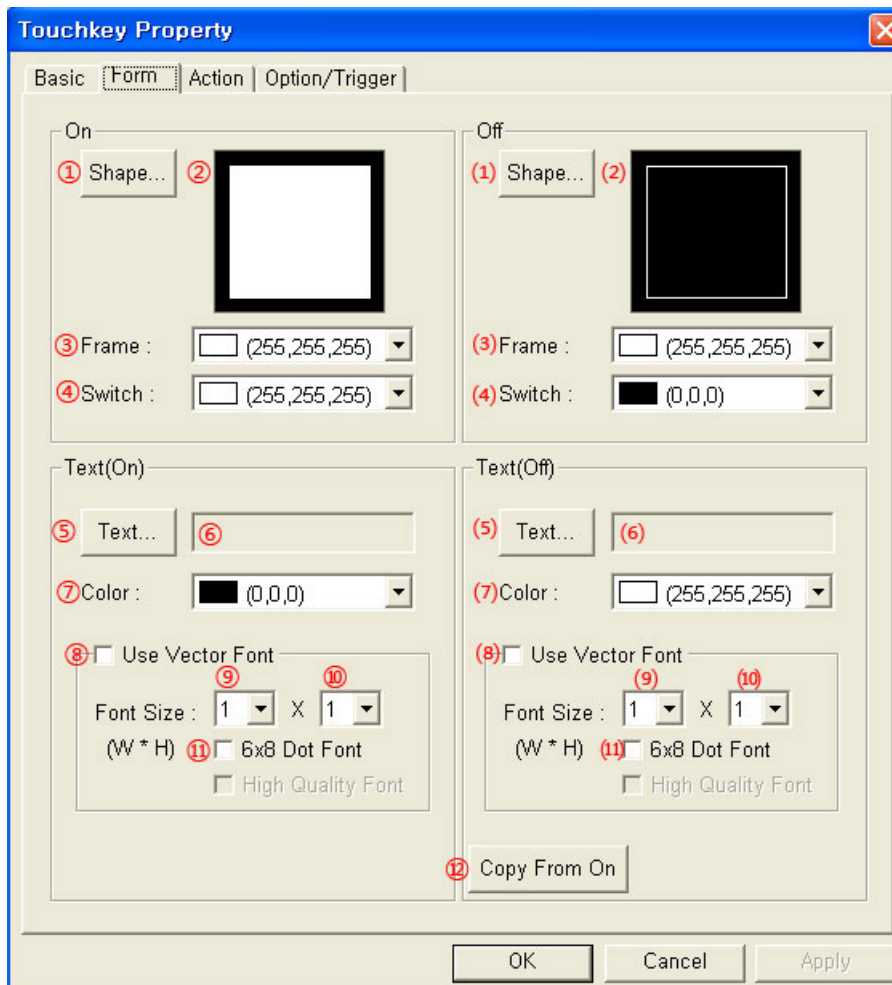

Form	Description
①Shape	Depending on the designation of shape in 'Basic' tab, this ① is different. <ul style="list-style-type: none"> • None: Not used. • Basic Figure: Click 'Shape', 'Image Selection' dialog box appears. Select basic figure supplied by GP Editor. • Part: Click 'Shape', 'Image Selection' dialog box appears. Select part. Touch size is minimized including ON/OFF part. If minimized size including ON/OFF part is smaller than minimized touch key, minimized touch key is created. • Graphic Library: Click 'Shape', 'Graphic Library' dialog box appears. Select the designated image on graphic library.
②Shape	Displays the selected shape image
③Frame	Designate frame color for ON. Activated only when shape is 'Basic Figure' in 'Basic' tab. <ul style="list-style-type: none"> • Mono type(GP-S044, GP-S057, LP-S044): White/Black • Color type(GP-S070, LP-S070): 24bit True Color
④Switch	Designate switch color for ON. Activated only when shape is 'Basic Figure' in 'Basic' tab. <ul style="list-style-type: none"> • Mono type(GP-S044, GP-S057, LP-S044): White/Black • Color type(GP-S070, LP-S070): 24bit True Color

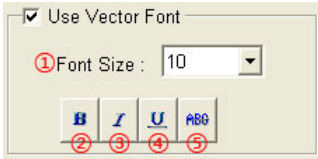
Form	Description
⑤Text※ ¹	Calls 'Edit Text' dialog box. Input and edit text for ON shape. Designate text position.
⑥Text	Displays text on touch key for ON.
⑦Color	Designates text color. <ul style="list-style-type: none"> ▪ Mono type(GP-S044, GP-S057, LP-S044): White/Black ▪ Color type(GP-S070, LP-S070): 24bit True Color
⑧Use Vector Font	Activated only for color type (GP-S070, LP-S070). Non-checking this, it uses bitmap font. Checking this, it displays as following.  ①Font size, ②Bold font, ③Italic font, ④Underline, ⑤Strikethrough
⑨Font Size (Width)	Designate width font size by pull-down menu. <ul style="list-style-type: none"> ▪ Range: 1,2,4,6,8 ▪ Height font size is 0.5, width font size 1 is only available.
⑩Font Size (Height)	Designate height font size by pull-down menu. <ul style="list-style-type: none"> ▪ Range: 0.5,1,2,3,4 ▪ Width font sizes besides 1 are not available for height font size 0.5.
⑪6x8 Dot Font	Designate 6x8 dot font.
(1) to (11)	Designate same setting with ① to ⑩ for OFF state.
⑫Copy From On	Copy the designated text for ON state to OFF state.



Note

※1. Position of text

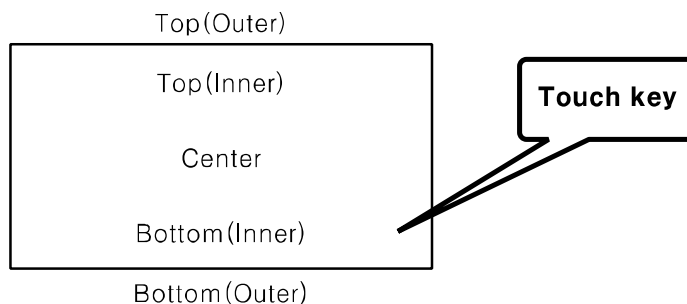

5.22.3.3 Action tab

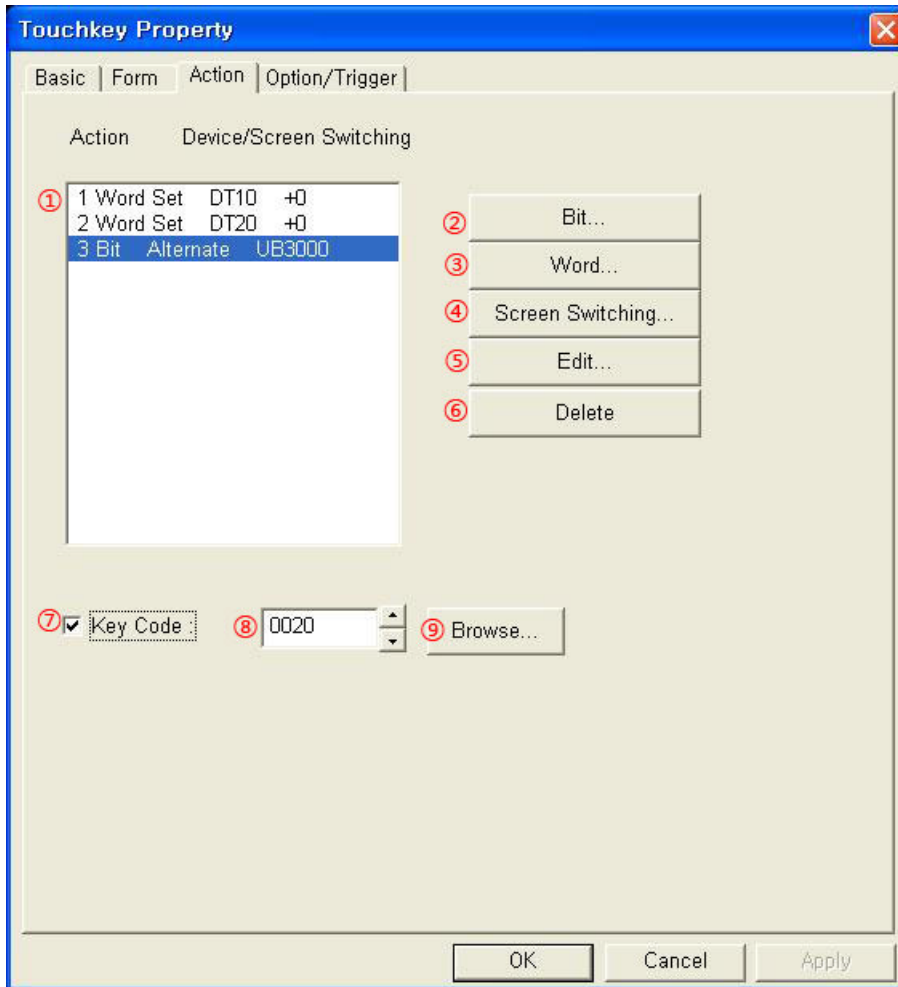

Action	Description
① Action List	Displays the designated touch key action. Double-click the desired item to edit.
② Bit	<p>Calls 'Bit Action' dialog box, designate bit action.</p> <p>① Device: Calls 'Device Select' dialog box and designate bit device. ② Action: Designate action of the device with touch.</p>

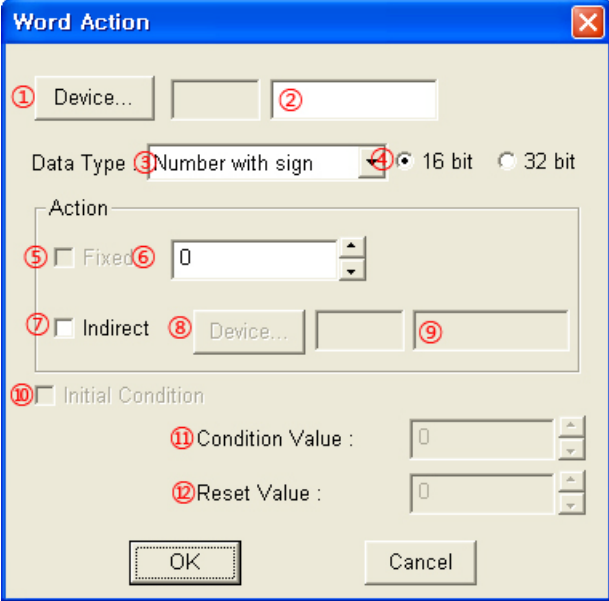
Action	Description
	<p>③ Set: Sets the device with touch.</p> <p>④ Reset: Resets the device with touch.</p> <p>⑤ Alternate: Alternates the current state ON to OFF or OFF to ON when touching.</p> <p>⑥ Momentary: Maintains momentary ON only when touching. Releasing touch, it turns OFF.</p>
③ Word	<p>Calls 'Word Action' dialog box, designate word action.</p>  <p>① Device: Calls 'Device Select' dialog box and designate touch key action setting device.</p> <p>② Device: Input device directly or displays the designated device.</p> <p>③ Data Type: Designate data type of the device by pull-down menu.</p> <p>④ Bit: Designate bit size of the device.</p> <p>⑤ Fixed: Check for inputting designated device at ⑥.</p> <p>⑥ Fixed: Designated fixed value for designated device.</p> <p>⑦ Indirect: Check for inputting designated device at ⑨ when ⑤ Fixed is not checked. When ⑤ Fixed is checked, adds up fixed value of ⑥ and designated device value of ⑨ to input the designated device at ②.</p> <p>⑧ Device: Calls 'Device Select' dialog box and designate indirect device.</p> <p>⑨ Device: Input device directly or displays the indirect device.</p> <p>⑩ Initial Condition: Resets as initial condition.</p> <p>⑪ Condition Value: Designate initial condition value to reset the designate device.</p> <p>⑫ Reset Value: Designate reset value.</p> <p>Depending on connected device type, it may use only 32bit. Refer to 'GP,LP user manual for communication'.</p>

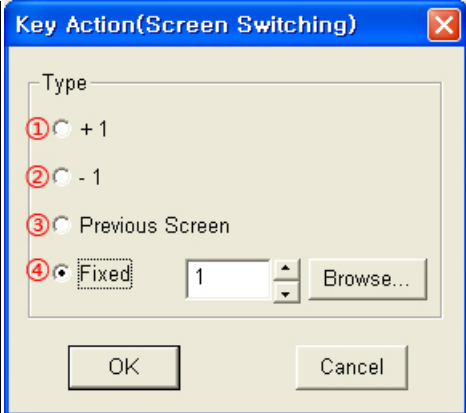
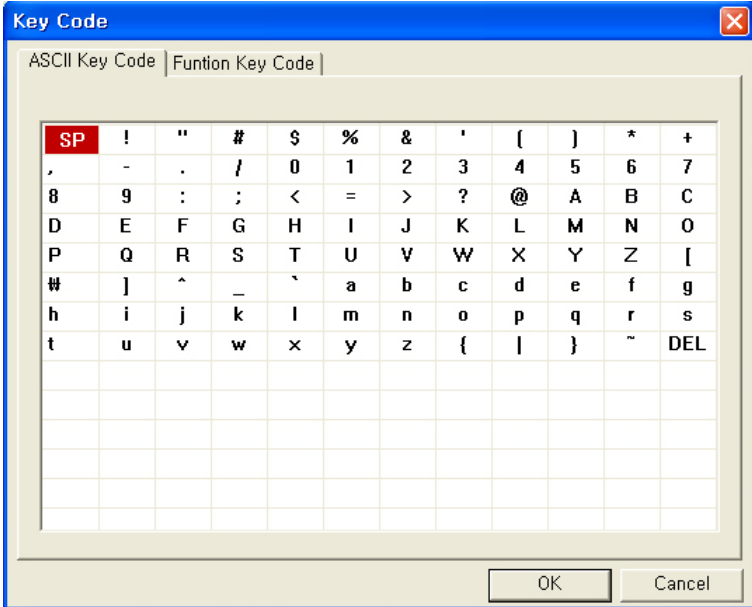
Action	Description
④Screen Switching	<p>Calls 'Key Action(Screen Switching)' dialog box, designate base screen switching.</p>  <p>①+1: Moves from current screen to one more number screen ②-1: Moves from current screen number to one less number screen ③Previous Screen: Moves to previous screen before switching ④Fixed: Moves to the designated screen</p>
⑤Edit	Edits the selected item in ④Action list.
⑥Delete	Delete the selected item in ④Action list.
⑦Key Code	Executes key code function.
⑧Key Code	Input directly key code or displays the designated function key code with hexadecimal.
⑨Browse	<p>Calls 'Key Code' dialog box, creates code for the desired function. 'ASCII Key Code' tab^{※1}</p> 

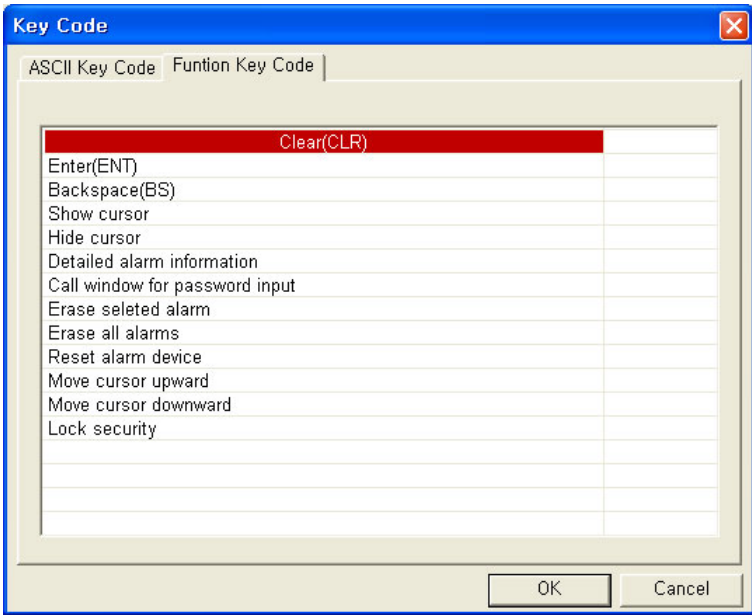
Action	Description
⑨ Browse	'Function Key Code' tab ^{※2} 

※1. Arrangement of character in 'ASCII Key Code' tab: Real code value on key code editor after completing input.

0020H	SP	0021H	!	0022H	"	0023H	#	0024H	\$	0025H	%
0026H	&	0027H	'	0028H	(0029H)	002AH	*	002BH	+
002CH	,	002DH	-	002EH	.	002FH	/	0030H	0	0031H	1
0032H	2	0033H	3	0034H	4	0035H	5	0036H	6	0037H	7
0038H	8	0039H	9	003AH	:	003BH	;	003CH	<	003DH	=
003EH	>	003FH	?	0040H	@	0041H	A	0042H	B	0043H	C
0044H	D	0045H	E	0046H	F	0047H	G	0048H	H	0049H	I
004AH	J	004BH	K	004CH	L	004DH	M	004EH	N	004FH	O
0050H	P	0051H	Q	0052H	R	0053H	S	0054H	T	0055H	U
0056H	V	0057H	W	0058H	X	0059H	Y	005AH	Z	005BH	[
005CH	?	005DH]	005EH	^	005FH	_	0060H	'	0061H	a
0062H	b	0063H	c	0064H	d	0065H	e	0066H	f	0067H	g
0068H	h	0069H	i	006AH	j	006BH	k	006CH	l	006DH	m
006EH	n	006FH	o	0070H	p	0071H	q	0072H	r	0073H	s
0074H	t	0075H	u	0076H	v	0077H	w	0078H	x	0078H	x
0079H	y	007AH	z	007BH	{	007CH		007DH	}	007EH	to

※2. 'Function Key Code' tab is selected when touching specified touch key by each function description.

Key code (Hexadecimal)	Description	Key code (Hexadecimal)	Description
FFA1	Clear(CLR)	FFA8	Erase selected alarm
FFA2	Enter (ENT)	FFA9	Erase all alarm
FFA3	Backspace(BS)	FFAA	Reset alarm device
FFA4	Show cursor	FFAB	Move cursor upward
FFA5	Hide cursor	FFAC	Move cursor downward
FFA6	Detailed alarm information	FFAD	Lock security
FFA7	Call window for password input		

5.22.3.4 Option/Trigger tab

Option/Trigger	Description
① Trigger Type	Designate trigger type by pull-down menu. <ul style="list-style-type: none"> ▪ Ordinary: Trigger function is not used. ▪ On: Executes touch key function when the device which is designated at ③ is ON. ▪ Off: Executes touch key function when the device which is designated at ③ is OFF.
② Device	Calls 'Device Select' dialog box. Designate trigger device.
③ Device	Input device directly or displays the designated device.
④ Auto Repeat	Executes repeatedly with regular intervals during pressing touch key.

5.23 Overlap Screen

Overlaps the current editing screen to desired screen. It is useful to produce common part among several screens as an independent screen to write screen data and save data capacity when using it as overlap screen. For window screen, overlap function is not available.

Select [Draw]-[Overlap Screen], 'Overlap Screen List' dialog box appears. Designate the deseired overlap screen.

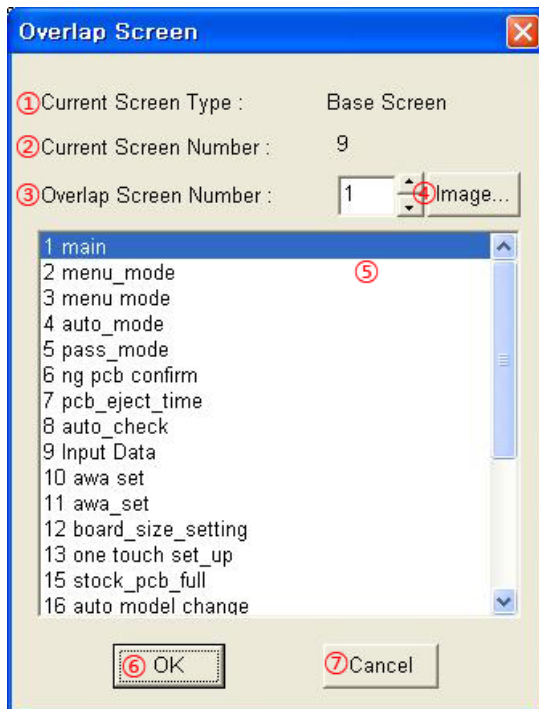

Overlap Screen	Description
①Current Screen Type	Base screen
②Current Screen Number	Current editing base screen number
③Overlap Screen Number	Base screen number to overlap
④Image	Calls 'Screen Image' dialog box, check base screen image.
⑤List Box	Displays base screen number and title of project.
⑥OK	Overlaps designated base screen at overlap screen number and closes 'Overlap Screen' dialog box.
⑦Cancel	Cancel the designations and closes 'Overlap Screen' dialog box.



Note

- It is able to overlap only as one step for each screen. When overlapping base screen which has overlap screen, tags of base screen are only overlapped, tags of overlap screen are not overlapped again.
- It is able to overlap up to 5 screens.

- When several screens are overlapped, it displays as in order to the tags which is placed on base screen, the tags which is placed on last overlapped screen, ..., the tag which is placed on first overlapped screen.
- Configuration of cursor movement and floating alarm is set again according to screen configuration, user and destination ID of tags configured in overlap screen maintains that value.



Ex.

[Example of overlap]

- Base screen



- Overlap screen

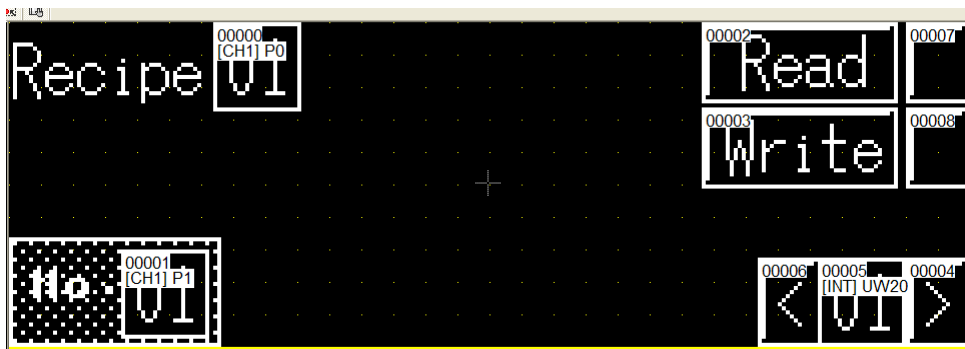

- Base screen after overlapping



5.24 Key Window Position

It is able to designate key window position for inputting numeral or ASCII input.

Select [Draw]-[Key Window Position], a red dotted rectangle follows mouse cursor at edit area. This rectangle is an outline of key window position when calling key window. If this rectangle is out of edit area, key window position is adjusted to show whole key window when calling key window.

When key window position is designated, all types of key window are displayed as window which has mark as top-left point.

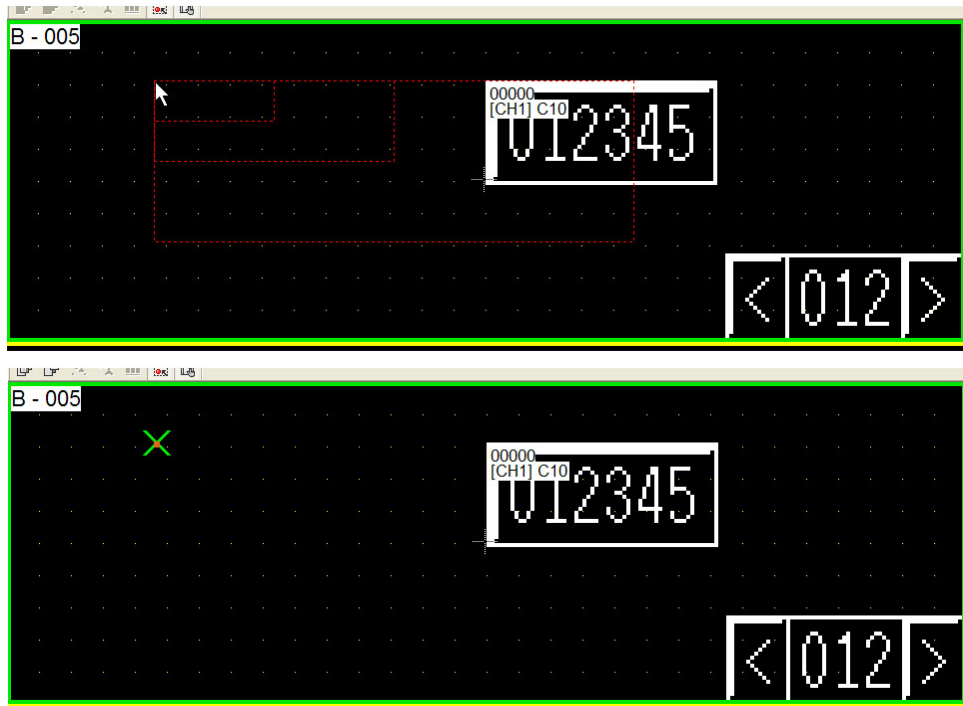

6 View

It describes tool bar option and view of tag/device list for edit.

6.1 Preview

Preview function is for showing GP/LP screen with 100% of enlargement ratio.

Select [View]-[Preview], 'Preview' window appears.

Screen background color is same as GP/LP screen. If white is designated, it shows white background color. It shows black background to the designated besides white.



6.2 Palette

GP palette has tag and draw tools for design.

Select [View]-[Palette] of menu, 'GP Palette' window appears. Likewise toolbar, select the desired tool from palette, design project.

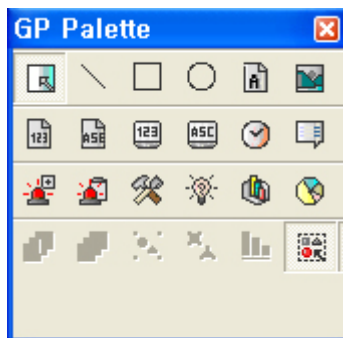

6.3 Graphic Library

Edits graphic library for bitmap tag, lamp tag, touch key tag.



Graphic Library	Description
① Graphic library tree view	Displays image files in GraphicLib folder as a tree.
② Preview	Previews image files in the selected folder at ①.
③ Create Folder	Creates lower folder of the selected folder at ①.
④ Delete Folder	Deletes the selected folder at ①. (All image files are deleted in the selected folder.)
⑤ Add File	Adds image file to the selected folder at ①.
⑥ Delete File	Deletes selected image file at ②.
⑦ OK	Completes graphic library editing.
⑧ Cancel	Cancel graphic library editing.

6.4 Tag List

It displays all tags of current editing screen and is able to edit each main property.

You can check all tags at once, or tags by that type separately.

Select [View]-[Tag List], 'Tag list' dialog box is appeared.

'All' tab displays all tags of the screen, the designated device, and position, etc. Such as 'Numeral Display, ASCII Display' tab, each tab displays the tag list by each tab name and it able to edit main property.

6.4.1 All tab

① Mod.	② Tag	③ Channel	④ Station	⑤ Monitor device	⑥ Trigger type	⑦ Position	⑧ Tag ID
1	Numeral Display	1	-	DT20		(0, 27)	00008
2	Numeral Display	1	-	DT21		(54, 27)	00009
3	Numeral Display	1	-	DT22		(108, 27)	00010
4	Numeral Display	1	-	DT23		(162, 27)	00011
5	Numeral Display	1	-	DT24		(0, 49)	00012
6	Numeral Display	1	-	DT25		(54, 49)	00013
7	Numeral Display	1	-	DT26		(108, 49)	00014
8	Numeral Display	1	-	DT27		(162, 49)	00015
9	Touch Key				Ordinary	(31, 19)	00016
10	Touch Key				Ordinary	(47, 19)	00017
11	Touch Key				Ordinary	(63, 19)	00018
12	Touch Key				Ordinary	(79, 19)	00019
13	Touch Key				Ordinary	(95, 19)	00020
14	Numeral Input	1	-	DT20	Ordinary	(15, 0)	00000
15	Numeral Input	1	-	DT21	Ordinary	(63, 0)	00001
16	Numeral Input	1	-	DT22	Ordinary	(111, 0)	00002
17	Numeral Input	1	-	DT23	Ordinary	(159, 0)	00003
18	Numeral Input	1	-	DT24	Ordinary	(15, 16)	00004
19	Numeral Input	1	-	DT25	Ordinary	(63, 16)	00005
20	Numeral Input	1	-	DT26	Ordinary	(111, 16)	00006

'All' tab of 'Tag List' dialog box displays all tags arranged in current editing screen with main attributions as a table.

In case that there is monitor device used for tag, 'Device' is activated when selecting the tag and it is able to edit device address clicking 'Device'. Edited device displays '*' mark in 'Modified' line. Select the desired tag and click 'Edit' or 'Delete', to edit or to delete.

All	Description
① Modified	Displays '*' when editing.
② Tag	Displays tag name.
③ Channel	Displays channel number of monitor device on tag. CH1 is 1, CH2 is 2. UB/UW device is '-'.
④ Station	Displays station of monitor device on tag. If there is no station information, displays '-'.
⑤ Monitor device	Displays monitor device on tag.
⑥ Trigger type	Displays designated trigger when using trigger.
⑦ Position	Displays tag position on screen (as top-left point).
⑧ Tag ID	Displays tag ID.

All	Description
⑨ Replace column	Check 'Replace column' and click 'Device' to change device. It changes all devices of monitor device column to new devices.
⑩ Device	Changes selected device to new device. Click 'Device Select' dialog box appears to designate new device.
⑪ Edit	Calls the selected tag's 'Property' dialog box to edit property.
⑫ Delete	Deletes the selected tag on screen.
⑬ Close	Closes 'Tag list' dialog box.

6.4.2 Numeral display tab

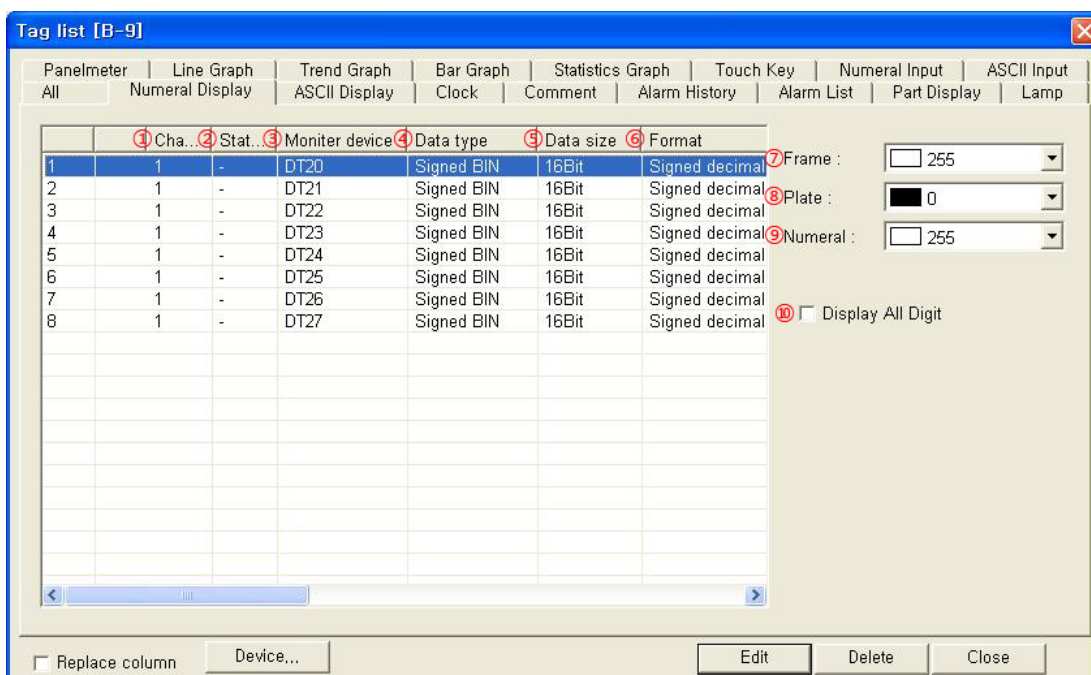

Numeral Display	Description
① Channel	Displays channel number of monitor device on tag. CH1 is 1, CH2 is 2. UB/UW device is '-'.
② Station	Displays address of monitor device on tag. If there is no address information, it displays as '-'.
③ Monitor device	Displays monitor device on tag
④ Data type	Displays data type of device
⑤ Data size	Displays data size of device
⑥ Format	Displays numeral display type.
⑦ Frame	Designates frame color. Activated only with when 'Shape' is checked in 'Numeral Display Property' dialog box. <ul style="list-style-type: none"> ▪ Mono type(GP-S044, GP-S057, LP-S044): White/Black ▪ Color type(GP-S070, LP-S070): 24bit True Color

Numeral Display	Description
⑧Plate	Designates plate color. Activated only with when 'Shape' is checked in 'Numeral Display Property' dialog box. <ul style="list-style-type: none"> • Mono type(GP-S044, GP-S057, LP-S044): White/Black • Color type(GP-S070, LP-S070): 24bit True Color
⑨Numeral	Designates numeral color. <ul style="list-style-type: none"> • Mono type(GP-S044, GP-S057, LP-S044): White/Black • Color type(GP-S070, LP-S070): 24bit True Color
⑩Display All Digit	Designate to display all digits option.

Tag list [B-9]

Panelmeter | Line Graph | Trend Graph | Bar Graph | Statistics Graph | Touch Key | Numeral Input | ASCII Input
 All | Numeral Display | ASCII Display | Clock | Comment | Alarm History | Alarm List | Part Display | Lamp

a Justify	b Disp all digits	c Size	d Digits	e Decimal point	Frame	P
Right alignm...	Not Present	1 X 1	6	0	255	0
Right alignm...	Not Present	1 X 1	6	0	255	0
Right alignm...	Not Present	1 X 1	6	0	255	0
Right alignm...	Not Present	1 X 1	6	0	255	0
Right alignm...	Not Present	1 X 1	6	0	255	0
Right alignm...	Not Present	1 X 1	6	0	255	0
Right alignm...	Not Present	1 X 1	6	0	255	0
Right alignm...	Not Present	1 X 1	6	0	255	0

Frame :

Plate :

Numeral :

Display All Digit

Replace column Device... Edit Delete Close

Tag list [B-9]

Panelmeter | Line Graph | Trend Graph | Bar Graph | Statistics Graph | Touch Key | Numeral Input | ASCII Input
 All | Numeral Display | ASCII Display | Clock | Comment | Alarm History | Alarm List | Part Display | Lamp

f Frame	g Plate	h Numeral	Trigger type	i Position	j Tag ID
255	0	255		(0, 27)	00008
255	0	255		(54, 27)	00009
255	0	255		(108, 27)	00010
255	0	255		(162, 27)	00011
255	0	255		(0, 49)	00012
255	0	255		(54, 49)	00013
255	0	255		(108, 49)	00014
255	0	255		(162, 49)	00015

Frame :

Plate :

Numeral :

Display All Digit

Replace column Device... Edit Delete Close

Numeral Display	Description
Ⓐ Justify	Displays alignment type for displaying numeral
Ⓑ Display all digits	Option for displaying all digits. (In case of right alignment, it displays all digit with 0 for blank) If this option is designated, it displays 'Present', otherwise it displays 'Not Present'.
Ⓒ Size	Displays font size as width X height on tag.
Ⓓ Digit	Displays digit
Ⓔ Decimal point	Displays decimal point digit
Ⓕ Frame	Displays frame color
Ⓖ Plate	Displays plate color
Ⓗ Numeral	Displays numeral color.
Ⓘ Position	Displays tag position on screen
⓷ Tag ID	Displays tag ID



Note

The descriptions of other tabs are same as 'Numeral Display' tab's.

6.5 Device List

Device list displays used all device for the project of the specified screen. You can check that which tag has any device and it is useful to correct any errors.

Select [View]-[Device List]-[Screen] of menu to check device list about screen, 'Device list – Screen' dialog box appears.

Select [View]-[Device List]-[Project] of menu to check device list about project, 'Device list – Project' dialog box appears.

Descriptions of 'Device list – Screen' is same as those of 'Device list – Project' dialog box. The followings describe 'Device list – Screen' dialog box as a representative. Besides that 'Bit' tab is bit device, 'Word' tab is word device, the descriptions of each tab are same.

① Channel	② Station	③ Device	④ Points	⑤ Tag	⑥ Tag ID	⑦ Position	⑧ Screen
1	-	R0		Touch Key	00000	(004,050)	B-1
1	-	R30		Touch Key	00000	(004,050)	B-1
1	-	R32		Touch Key	00000	(004,050)	B-1
1	-	R0		Touch Key	00001	(004,020)	B-1
1	-	R32		Touch Key	00001	(004,020)	B-1
1	-	R34		Touch Key	00001	(004,020)	B-1
1	-	R0		Touch Key	00002	(122,020)	B-1
1	-	R30		Touch Key	00002	(122,020)	B-1
1	-	R34		Touch Key	00002	(122,020)	B-1
1	-	R60		Touch Key	00000	(004,020)	B-2
1	-	R40		Touch Key	00000	(004,020)	B-2
1	-	R61		Touch Key	00001	(083,020)	B-2
1	-	R41		Touch Key	00001	(083,020)	B-2
1	-	R62		Touch Key	00002	(162,020)	B-2
1	-	R42		Touch Key	00002	(162,020)	B-2
1	-	R34		Touch Key	00005	(004,050)	B-2
1	-	R64		Touch Key	00000	(004,020)	B-3
1	-	R45		Touch Key	00000	(004,020)	B-3
1	-	R44		Touch Key	00000	(004,020)	B-3
1	-	R65		Touch Key	00002	(122,020)	B-3
1	-	R44		Touch Key	00002	(122,020)	B-3
1	-	R45		Touch Key	00002	(122,020)	B-3
1	-	R63		Touch Key	00003	(083,050)	B-3
1	-	R43		Touch Key	00003	(083,050)	B-3
1	-	R34		Touch Key	00004	(162,050)	B-3
1	-	R11A		Touch Key	00000	(004,020)	B-4

Device list	Description
① Channel	Displays channel number of used device
② Station	Displays station of used device
③ Device	Displays used device.
④ Points	Displays the number of related device when the tag uses several devices from lead device in order.
⑤ Tag	Displays tag list of used device.
⑥ Tag ID	Displays tag ID.

Device list	Description
⑦ Position	Displays tag position on screen (as top-left point).
⑧ Screen	Displays screen number having tag. If the device is designated at common, it displays common.
⑨ Replace Device	Calls 'Replace Device' dialog box to replace the selected item device.
⑩ Find	Calls 'Device Select' dialog box and input the desired device to find. If there is same device with input device, it scrolls to the position and shows as the item is selected.

6.6 Overlap Screen List

Overlap screen creates a new screen by combining existing screens.

Select [View]–[Overlap Screen List] of menu, 'Overlap Screen List' dialog box appears.

You can check the overlapped screen list and edit it.

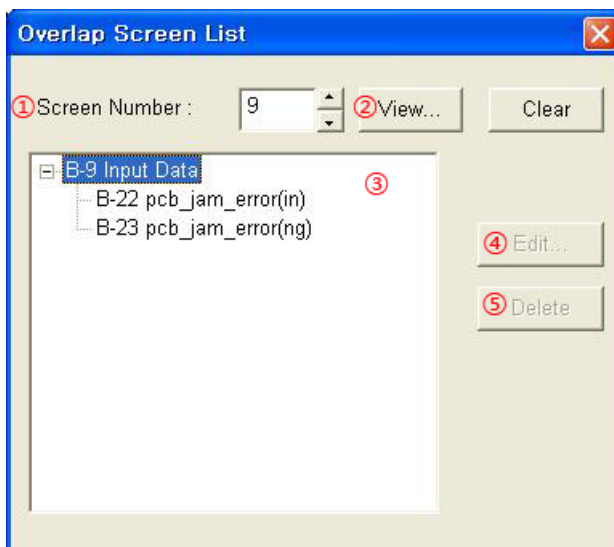

Overlap Screen List	Description
① Screen Number	Designate base screen to display overlap screen list.
② List	Lists base screen image to select the screen which is input at 'Screen Number'.
③ Tree view	Displays overlap screen number and title. The below screen is the latest overlapped screen.
④ Edit	Replaces the selected screen on tree to other screen. Select overlapped screen number at ③ Tree view and click 'Edit'. 'Overlap Screen' dialog box is appears. Input or select the to be overlapped screen number, and click 'OK' and ③ Tree view is replaced as to be overlapped screen number.
⑤ Delete	Deletes the selected overlap screen on tree.

6.7 Status bar

Status bar displays the information of current editing (Selected tag, mouse cursor coordinates, PLC of CH1/CH2) on the below GP Editor. It is displayed when checking [View]-[Status bar]. If the specified tag is selected, '[...] is selected' message displays. The others, 'READY' message displays.

6.8 Toolbar

It is able to operate display of specified group of tool in menu or designate in project configuration. Designate it in 'Browse' tab of 'Option' dialog from [Project]-[Option] of menu, or with checking from [View]-[Toolbar].

- System toolbar: Designates displaying main toolbar or not.
 - New project, load project, save project
 - New screen, load screen, save screen
 - Cut, copy, paste
 - Preview, previous screen, next screen, open closed screen, tag list
 - Download, upload, connect PLC, check data
 - Device list, comment list, library, palette, refresh
- View toolbar: Designates displaying view toolbar or not.
 - ON/OFF image, Device display, Tag ID display, grid color, background color
 - Snap, grid interval, grid display type, enlargement ratio
- Figure toolbar: Designate displaying figure toolbar or not.
 - Line, rectangle, circle, text, BMP
- Edit toolbar: Designate displaying edit toolbar or not.
 - Bring forward, send backward, group, ungroup, select object-figure, select object-tag
- Tag toolbar: Designate displaying tag toolbar or not.
- Draw toolbar: Designate displaying draw toolbar or not.
 - Line - Style, Color
 - Pattern - Pattern, foreground color, background color
 - Text color
- Workspace bar: Designate displaying workspace for base, window screen list of project.

6.9 ON Image

Some tag such as lamp, touch key tag, etc are different image for ON/OFF state on screen. In this case, you can designate ON or OFF state image on screen.

Select [View]-[ON Image] of menu, or click  in toolbar.

If [View]-[ON Image] of menu is checked, each tag which is ON state is displayed on edit area.

6.10 Refresh

This feature is to refresh editor screen.

6.11 Option

Grid display, magnification, snap, tag ID display and device display are for making screen data efficiently. It is able to configure in 'Browse' tab. It is same as [Project]-[Option] of meun.

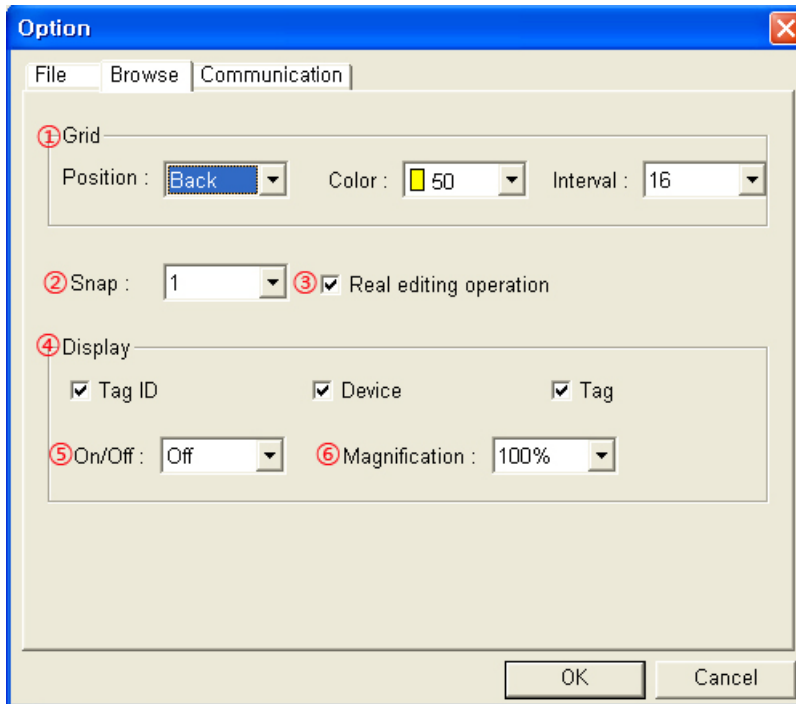

Option	Description
① Grid	Designate grid for indicating arrangement when editing screen by pull-down menu. <ul style="list-style-type: none"> Position: Front=Displays on the tag, Back=Displays under the tag, None=Does not display Color: White, black, blue, red, pink, light green, light blue and yellow Interval: 2, 4, 5, 8, 10, 16, 20, 40, 80, Mesh
② Snap	Designate snap range of screen by pull-down menu. <ul style="list-style-type: none"> Range: 1, 2, 4, 5, 8, 10, 16, 20, 40, 80, Mesh (A mesh indicates same size of resolution of touch switch.) GP-S057, GP-S070, LP-S070: 20X20 GP-S044, LP-S044: 16X20
③ Real editing operation	Check for displaying object as it is when it is moving, or non-check for displaying only with dotted line.
④ Display	<ul style="list-style-type: none"> Tag ID: Displays tag ID Device: Displays device name related tag. Tag: Displays tag content
⑤ On/Off	Designate ON or OFF image state on edit area by pull-down menu.
⑥ Magnification	Select magnification ration between 100%, 200%, 300%, or 400% based on GP/LP screen size by pull-down menu.

7 Communication

GP Editor and GP/LP communicate with RS232C/RS422 port, Ethernet port, or USB port. (Mono type(GP-S044, GP-S057, LP-S057) is available only for RS232C/RS422 port.)

Following functions are available by communications between GP Editor and GP/LP.

- Download screen data
Downloads the edited project in GP Editor to GP/LP
- Upload GP/LP data
Uploads protocol saved in GP/LP to GP Editor
- GP/LP memory check
Check memory and delete the desired screen of GP/LP from GP Editor
- Firmware download
Upgrade GP/LP software (Firmware upgrade for color type(GP-S070, LP-S070) is available only by USB Host port.)



Note

- For RS232C/RS422 port;
You should designate communication channel as 'EDITOR' in [SYSTEM SETTING]-[Connect PLC] of mono type GP/LP or in [SYSTEM SETTING]-[Environment]-[Serial Communication] of color type GP/LP. For connecting with GP Editor, designate GP/LP as data length: 8 bit, stop bit: 1 bit, parity: EVEN, flow control: XON/XOFF. Communication is available only when both GP Editor and GP/LP have same set baud rate.
- For Ethernet port;
You should designate IP Address, Subnet Mask, GateWay at system menu [SYSTEM SETTING]-[Local Ethernet] in GP/LP.
- For USB port;
It does not need additional settings.

7.1 Download

After editing screen data, select [Communication]-[Download] of menu, or click  in toolbar, 'Monitor Data Download' dialog box appears. Set data to download and download option, click 'Download' to start download.

7.1.1 Download instructions

- All existing draw data of GP/LP by each project are deleted.
- In case of GP, when downloading the screen data, CH1, CH2 communication stops. When finishing downloading, the communication starts.
In case of LP, when downloading the screen data, CH1, CH2 communication stops but PLC operates continuously. When finishing downloading, CH1, CH2 communication starts.

7.1.2 Property

Configuration	Description
① All Data	Downloads all existing screen data of current project.
② Selected Data	Downloads selected data of current project. When it is selected, 'Base, Window, Other' tabs are activated. Select the desired item to be downloaded in each tab.
③ Protocol download	Non-checking this, it checking whether there is a device or not and then downloads the appropriate protocol only when there is not a device to be downloaded on GP/LP memory. Checking this, it downloads unconditionally the appropriate protocol even though there is a device to be downloaded on GP/LP memory.
④ Project Title	Displays project name. Select [Common]-[Title]-[Project] of menu to edit project name.
⑤ Project ID	Displays project ID to be downloaded.

Configuration	Description
⑥ GP/LP Type	Displays GP/LP type
⑦ Download	Starts download
⑧ Close	Closes 'Monitor Data Download' dialog box
⑨ Setting	Designates communication setting between PC and GP/LP. 'Option' dialog box appears. Select [Communication]-[Option] of menu, 'Option' dialog box appears also. In 'Communication' tab, designate communication setting.
⑩ Size	Displays total screen data of to be downloaded project with Kbyte unit. Maximum size of one project is up to 512Kbyte. (For LP series, it cannot over 384Kbyte.)

7.1.2.1 Base tab

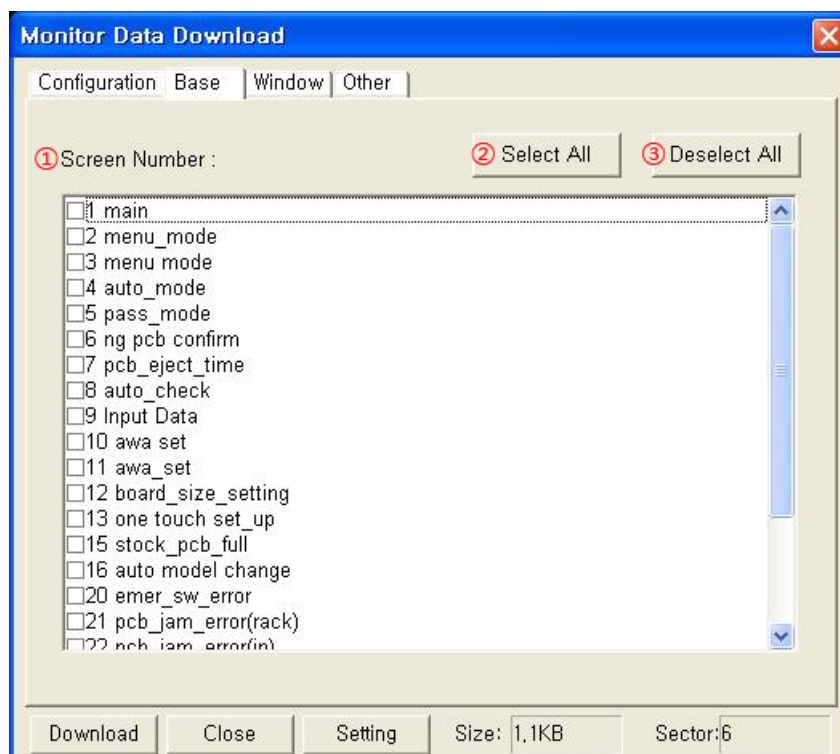

Base	Description
① Screen Number	Displays base screens number and title of the project in order of number. Downloads only checked screen.
② Selected All	Selects all items of the list.
③ Deselect All	Deselects all items of the list.

7.1.2.2 Window tab

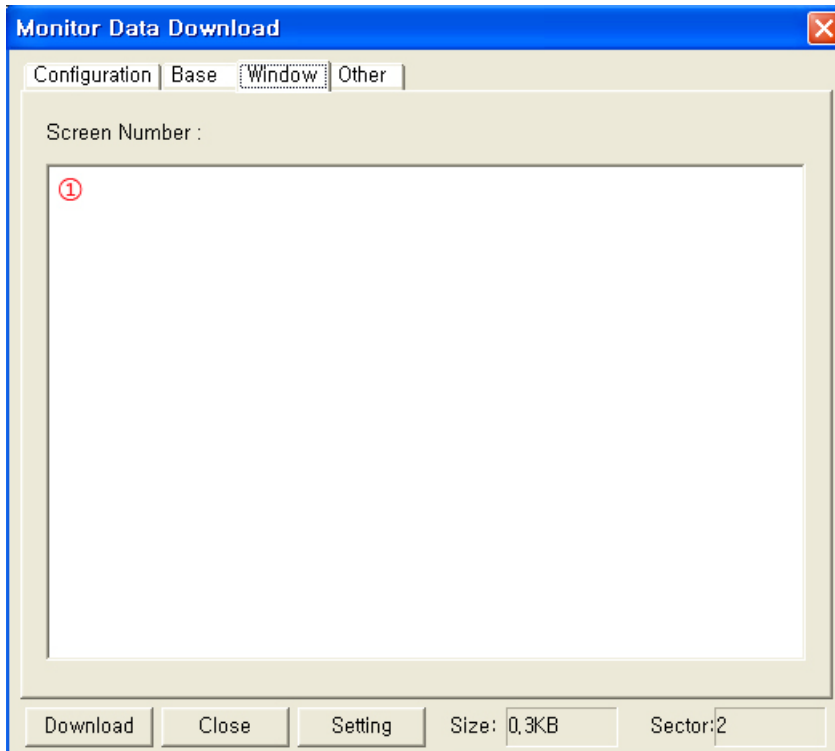

Window	Description
① Screen List	Lists the designated window screen by key window at project auxiliary property. You cannot select the desired item to be downloaded.

7.1.2.3 Other tab

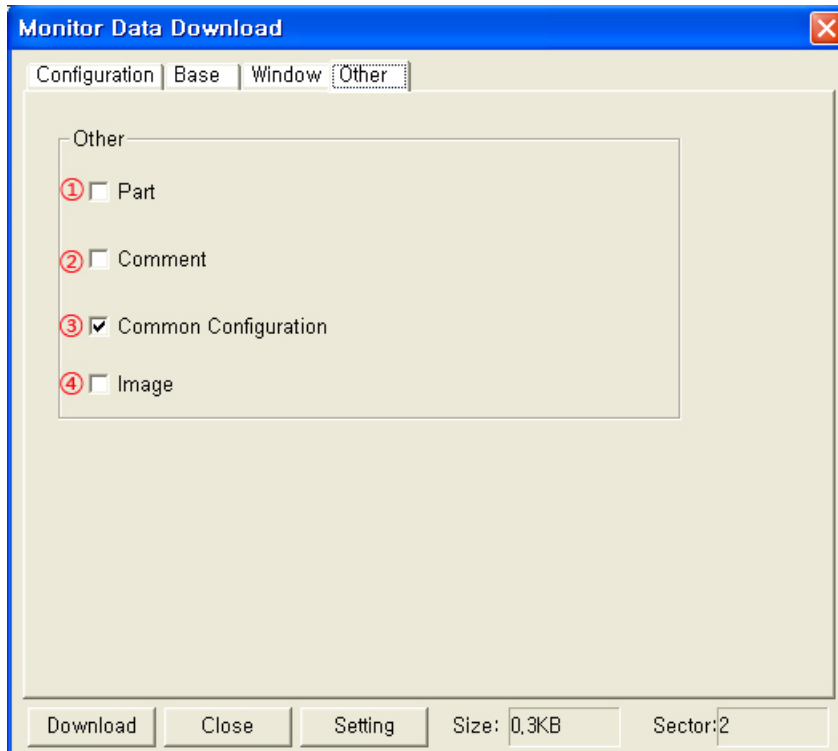

Other	Description
①Part	Downloads all registered parts of the project.
②Comment	Downloads all registered comments of the project.
③Common Configuration	Downloads all registered items at common configuration.
④Image	Downloads all registered images of the project. (It is available only for color type (GP-S070, LP-S070).)

7.2 Upload

It uploads monitoring project file in GP/LP to GP Editor. You can upload alarm history list also. Select [Communication]-[Upload] of menu, or click  in toolbar, 'Monitor Data Upload' dialog box appears to designate about upload and to execute upload.

7.2.1 Execution order

- 1st Check communication setting for GP Editor and GP/LP.
- 2nd To upload all data of project, select 'All Data' in Tag box.
 - To upload selected data of project, select 'Selected Data' in Tag box, and click 'Read Title'. 'Base, Window, Other' tabs are activated, check the desired item.
 - To upload alarm history list, check 'Alarm History(Alarmhistory.txt)'.
 - To upload alarm frequency, check 'Alarm Frequency(Alarmfrequency.txt)'.
- 3rd If there is password, enter it to 'Password'.
- 4th Click 'Upload' and it operates upload.

7.2.2 Property

7.2.2.1 Configuration tab

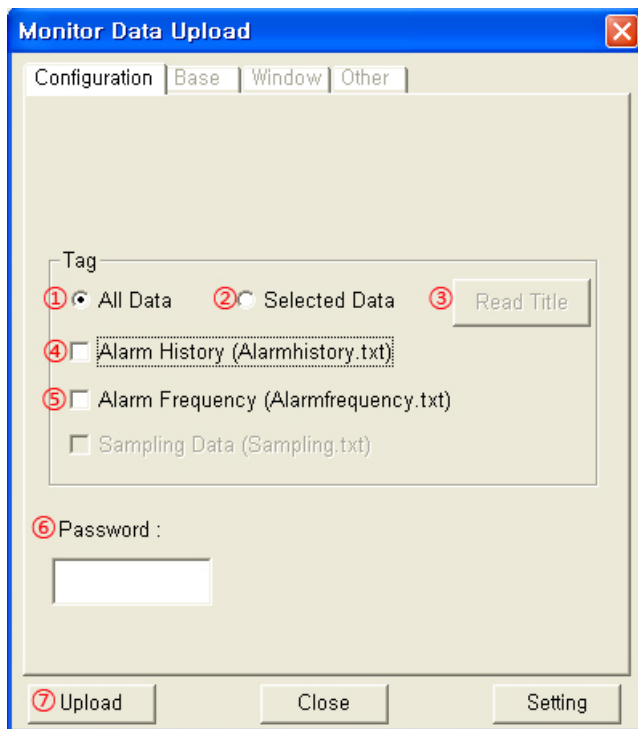

Configuration	Description
① All Data	Uploads all screen data.
② Selected Data	Uploads selected data of the project. Select this and click 'Read Title'. It communicates GP/LP and reads screen information. 'Base, Window, Other' tabs are activated, and check the desired item from each tab.
③ Read Title	Reads base/window screen of GP/LP number and title by communicating.
④ Alarm History	Check for uploading alarm history. It saves at \GP Editor installed folder\Temp\Upload \Project ID\Project title\AuxInfo as 'Alarmhistory.txt' file.
⑤ Alarm Frequency	Check for uploading alarm frequency. It saves at \GP Editor installed folder\Temp\Upload\Project ID\Project title\AuxInfo as 'Alarmfrequency.txt' file.
⑥ Password	Enter password which is designated at [Common]-[Password] of menu. Correct password is available to upload.
⑦ Upload	Executes upload.

7.2.2.2 Base tab

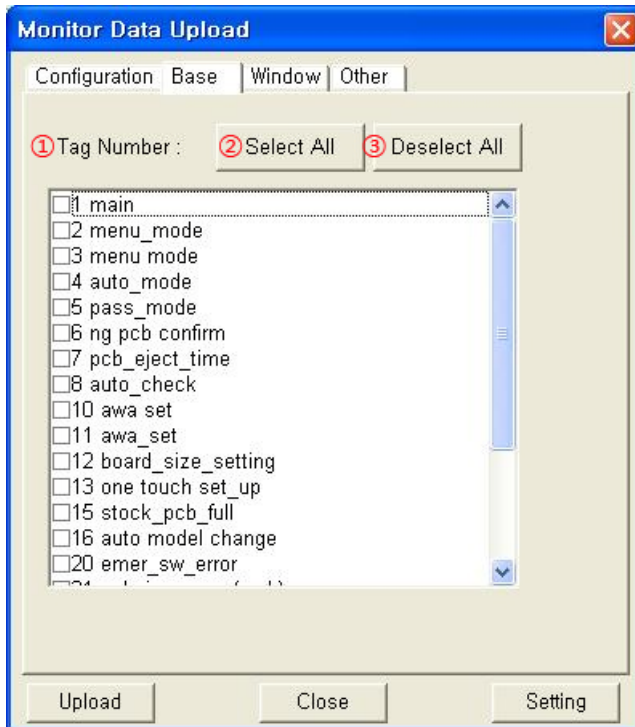

Base	Description
① Tag Number	Displays base screens number and title of GP/LP in order of number. Uploads only checked screen.
② Select All	Select all items of the list.
③ Deselect All	Deselect all items of the list.

7.2.2.3 Window tab

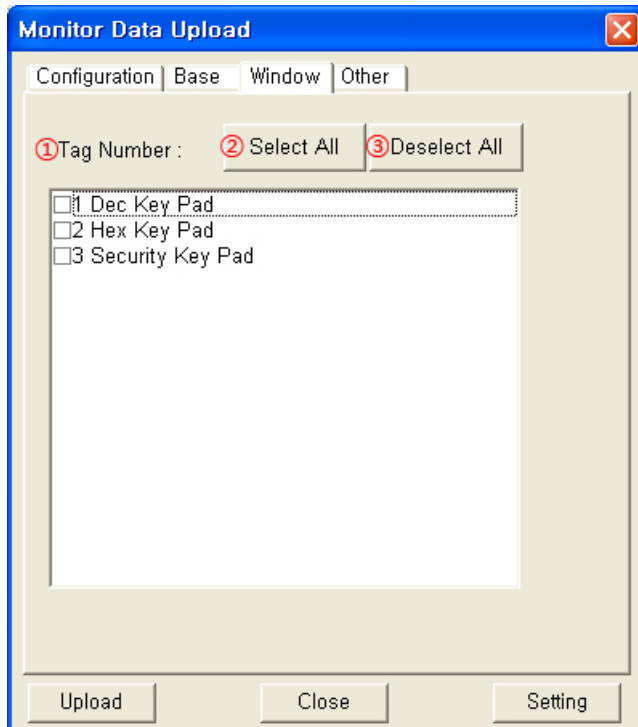

Window	Description
① Tag Number	Displays window screens number and title of GP/LP in order of number. Uploads only checked screen.
② Select All	Selects all items of the list.
③ Deselect All	Deselects all items of the list.

7.2.2.4 Other tab

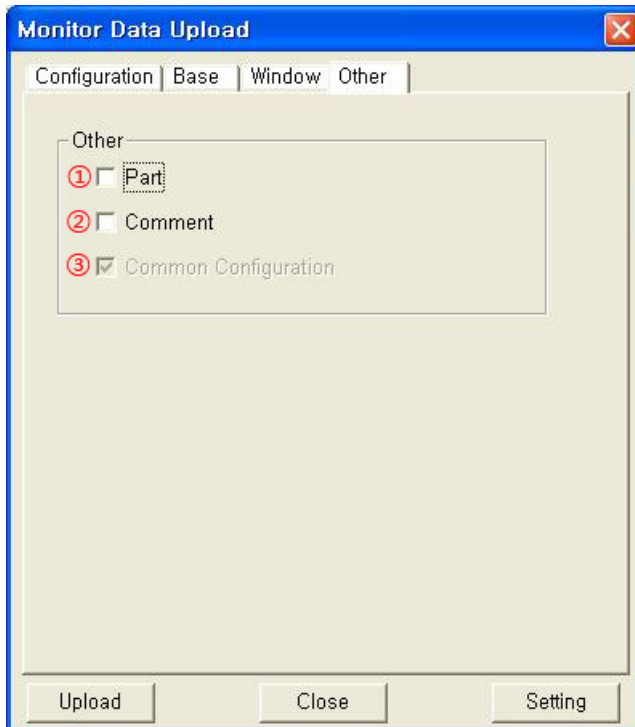

Other	Description
①Part	Uploads all registered parts of the project.
②Comment	Uploads all registered comments of the project.
③Common Configuration	Uploads all registered items at common configuration. Some configurations which are able to designate at GP/LP such as time action, project auxiliary setting are uploaded as download setting.

7.3 Memory

This menu is able to check project screens, memory size, firmware version in GP/LP. Also it is able to delete the desired screen of the project. It is not reading memory to bring all data, displays main attributions about the project to users.

7.3.1 Execution order

- 1st Select [Communication]-[Memory] of menu.
- 2nd 'Do you want to cancel monitoring and read memory information?' message appears.
- 3rd If there is password which is designated at [Common]-[Password] of menu, password dialog box appears. Not correct password cancels the memory instruction.
- 4th If there is not password which is designated at [Common]-[Password] of menu, or correct password is entered, 'Memory' dialog box appears.
- 5th Execute the desired operation in 'Memory' dialog box.

7.3.2 Property

7.3.2.1 Base tab

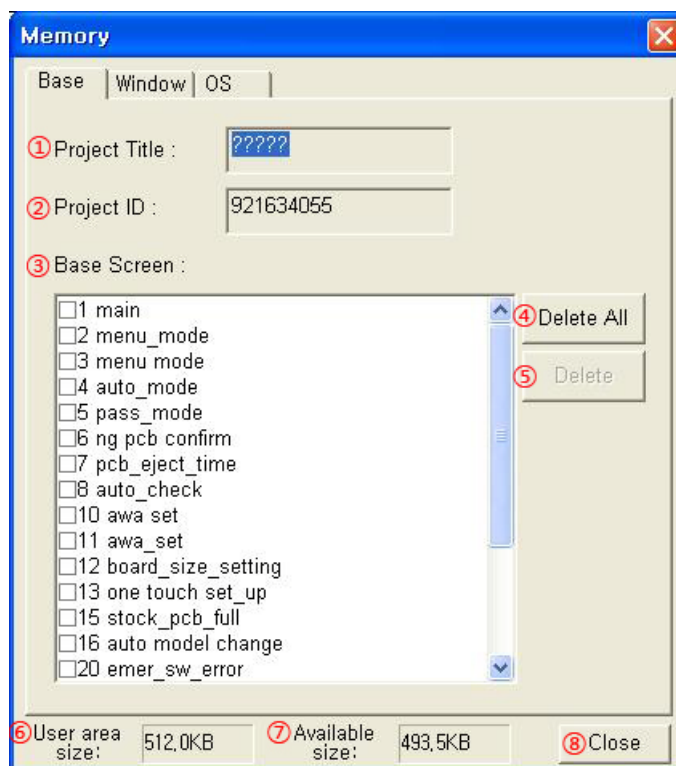

Base	Description
①Project Title	Displays project title in GP/LP.
②Project ID	Displays project ID in GP/LP.
③Base Screen	Displays base screen list of the project in GP/LP. Select the desired item and 'Delete' is activated. Click 'Delete' and it deletes the selected item in GP/LP memory.
④Delete All	Deletes all base screen of GP/LP.

⑤ Delete	Deletes checked item in list box.
⑥ User area size	Displays total user area size with byte unit.
⑦ Available size	Displays available free area size with byte unit.
⑧ Close	Closes 'Memory' dialog box.

7.3.2.2 Window tab

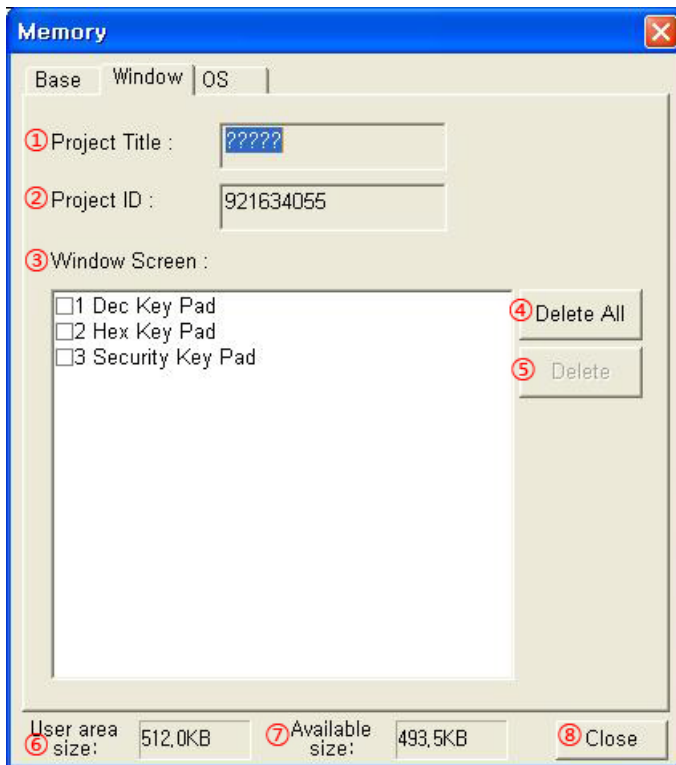

Window	Description
① Project Title	Displays project title in GP/LP.
② Project ID	Displays project ID in GP/LP.
③ Window Screen	Displays window screen list of the project in GP/LP. Select the desired item and 'Delete' is activated. Click 'Delete' and it deletes the selected item in GP/LP memory.
④ Delete All	Deletes all window screen of GP/LP.
⑤ Delete	Deletes checked item in list box.
⑥ User area size	Displays total user area size with byte unit.
⑦ Available size	Displays available free area size with byte unit.
⑧ Close	Closes 'Memory' dialog box

7.3.2.3 OS tab

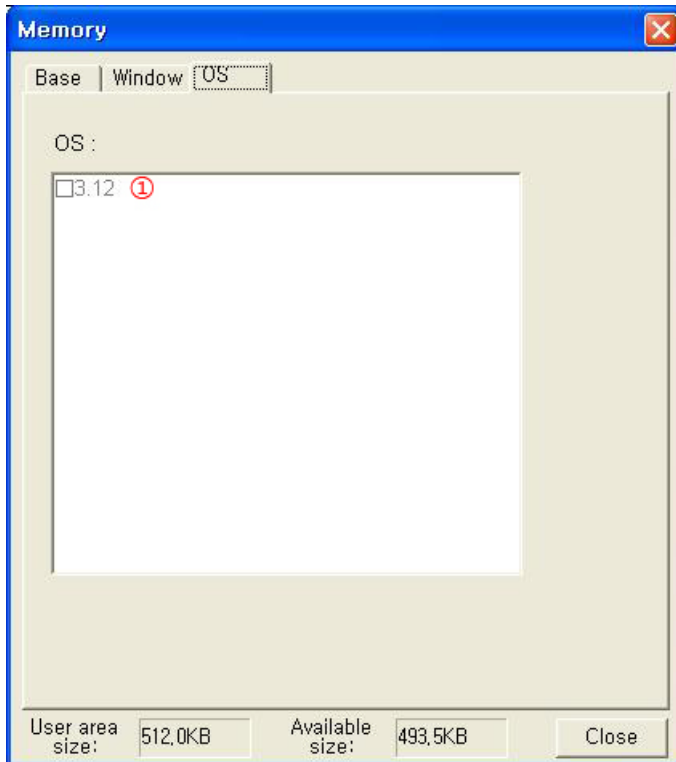

OS	Description
①List box	Displays firmware version of GP/LP. Select [Communication]-[GP Firmware Download] of menu and download upgraded firmware.

7.4 Check Data

You may create error data when editing screen data in GP Editor. Therefore, GP Editor helps you to find for correcting and editing error data by checking data. This data checking is operated automatically when downloading data to GP/LP.

If there is error data, 'Data check' dialog box appears and lists error list. 'Data check' dialog box is modeless dialog box which enable to edit continue.

7.4.1 Area tab

It checks data and lists the tag which is out of edit area.

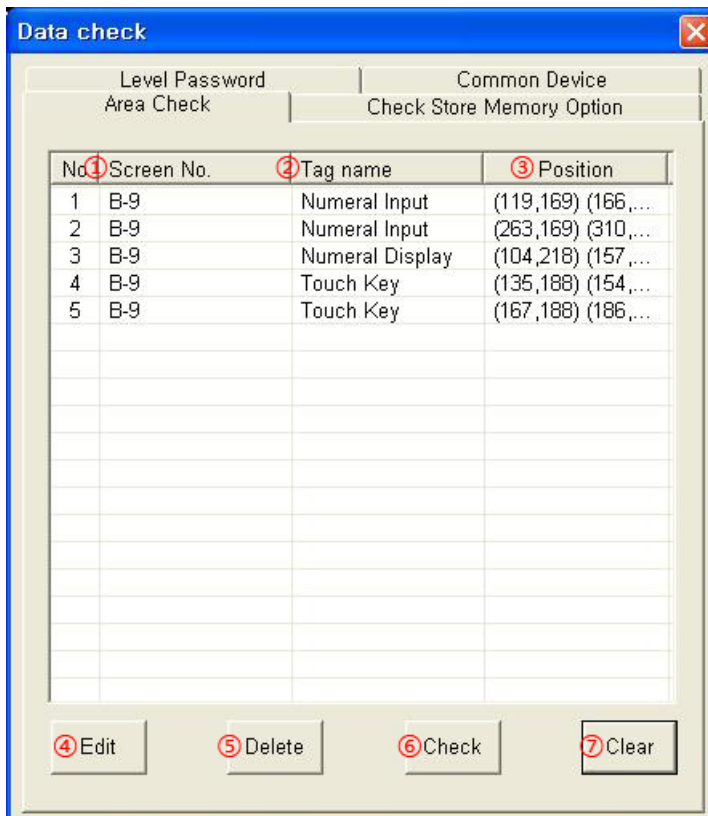

Area Check	Description
① Screen No.	Displays base or window screen number of the specified tag.
② Tag name	Displays the specified tag name.
③ Position	Displays tag coordinates as '(left, top) (right, bottom)' form.
④ Edit	Select the desired item to edit and click 'Edit'. Selected item is displayed with selected state on the edit area. To double-click the desired item is same function.
⑤ Delete	Deletes the selected tag item.
⑥ Check	Executes data check again.
⑦ Clear	Closes 'Data check' dialog box.

7.4.2 Check store memory option tab

A project should have up to 17 store memory options for alarm list and trend graph. You can check the number of this option. This tab displays tag list which has store memory option to edit attributions. The descriptions of 'Check Store Memory Option' tab are same as 'Area Check' tab's.

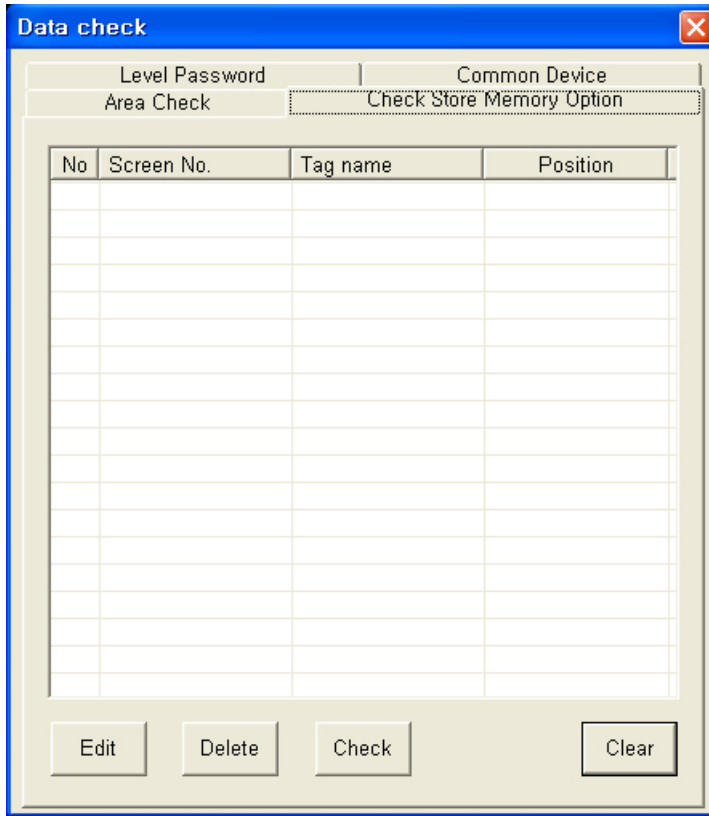

7.4.3 Level password tab

It checks whether password is input for the top security level of base screen with project security level or not.

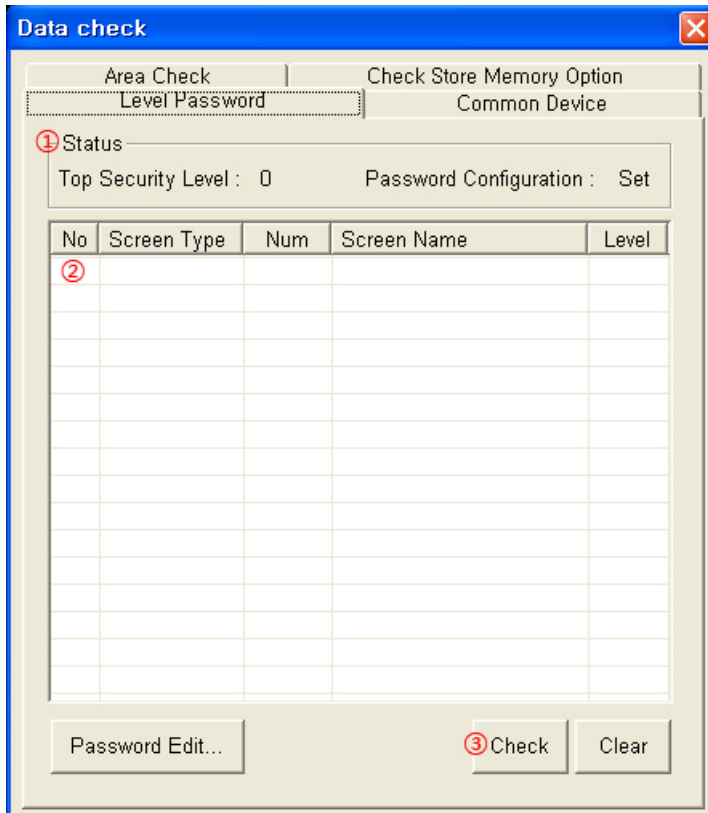

Level Password	Description
① Status	Displays top security level and whether there is set password or not for editing base screens. <ul style="list-style-type: none"> Top Security Level: Top security level among base screens. Password Configuration: If there is not set password, 'Not' is displayed. If there is set password, 'Set' is displayed.
② List Box	Displays screen number which is top security level, and the level. Double-click and 'Security' dialog box of [Common]-[Security] of menu appears to edit security level and password.
③ Check	Click this after editing or inputting security level and password, and it checks for security level again. If there is no error, 'Password Configuration' of ① Status displays 'Set'.

7.4.4 Common device tab

It checks there is same device registered at [Common] menu for the project or not.

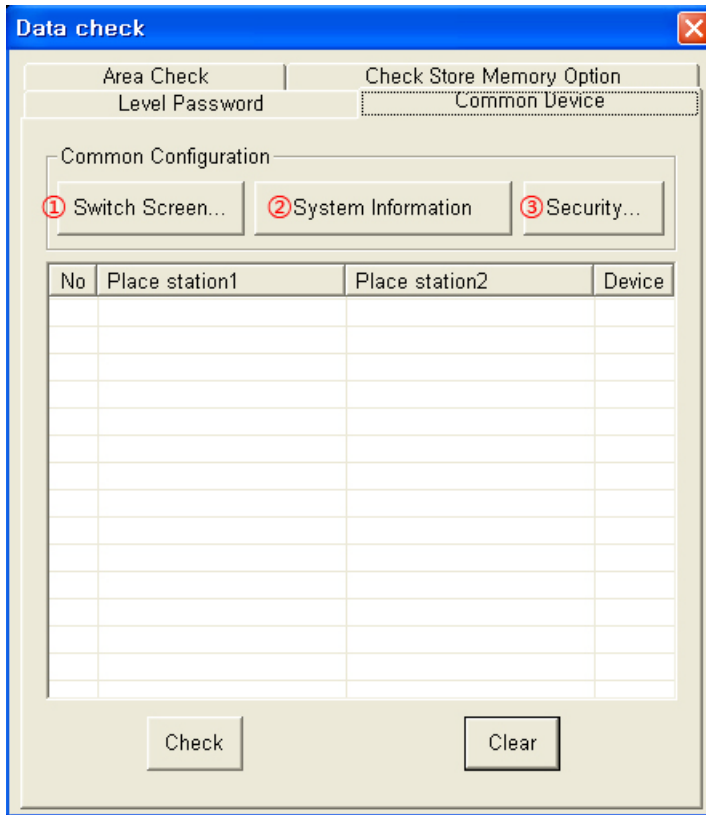

Common Device	Description
① Switch Screen	Calls 'Switch Screen' dialog box from [Common]-[Switch Screen] of menu to check the used device for switching 'base screen, overlap window 1, 2'.
② System Information	Calls 'System Information' dialog box from [Common]-[System Information] of menu to check the device state for communicating between GP/LP and PLC device.
③ Security	Calls 'Security' dialog box from [Common]-[Security] of menu to check the device state about security level for project.

7.5 GP Firmware Download

You can download and upgrade firmware of GP/LP by GP Editor.

7.5.1 Firmware download execution order

7.5.1.1 Mono type

- 1st Firmware file is different as GP/LP model. Download a firmware file from www.autonics.com.
- 2nd You can download only for same firmware GP/LP type with GP/LP type designated at GP Editor. Select [Common]-[GP/PLC Type] of menu, 'GP/PLC Type' dialog box appears. By pull-down menu, designate to be downloaded GP/LP type.

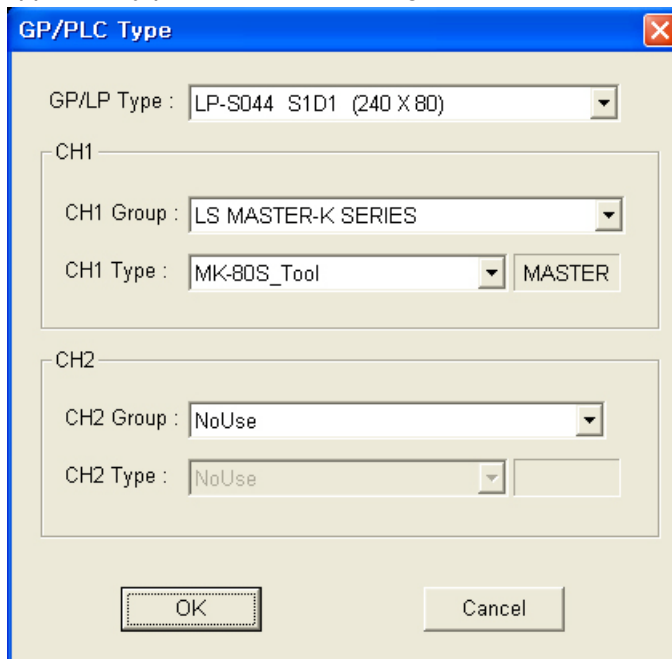

- 3rd Select [Communication]-[GP Firmware Download] of menu and 'GP Firmware Download' dialog box appears.

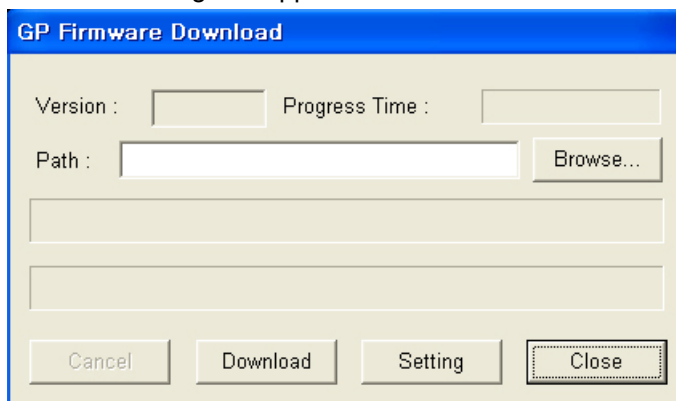

- 4th Click 'Browse' and select firmware file to be downloaded.

5th Click 'Download' and the firmware information dialog box for current GP/LP firmware appears and asks whether to download or not. If connected GP/LP is not same as the designated GP/LP type from [Common]-[GP/PLC Type] of menu, error message appears.

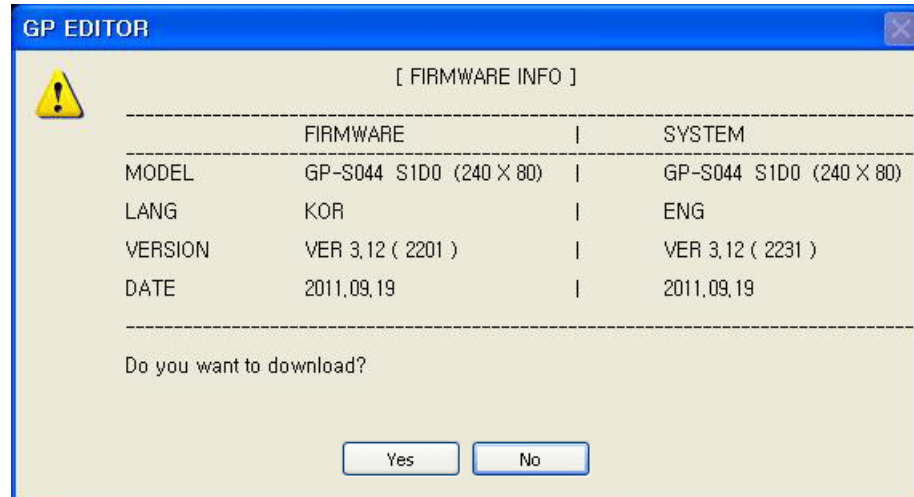

6th Click 'Yes' and GP/LP screen displays 'GP FIRMWARE UPGRADE' message. GP Editor displays 'GP Firmware Download' dialog box and download progresses.

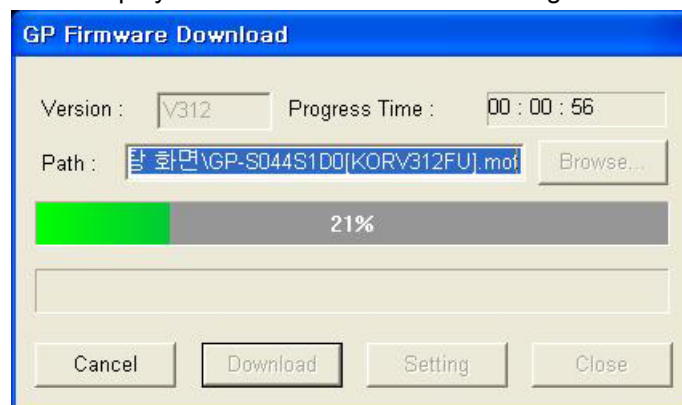

If you want to discontinue download, click 'Cancle' and 'Do you want to interrupt firmware download?' message appears. Click 'Yes' and it discontinues download. For discontinuing downloaod, re-start GP/LP.

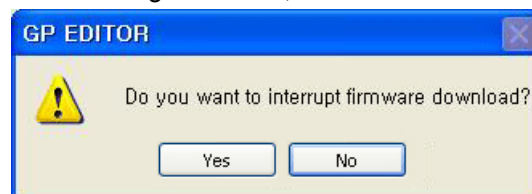

7th When completing download successively, GP/LP displays 'UPGRADE OK PLEASE POWER OFF' message.

When failing donwload, GP/LP displays 'UPGRADE NG PLEASE POWER OFF' message. Re-start GP/LP. GP/LP maintains before firmware version and it does not affect to GP/LP operation.

7.5.1.2 Color type

GP Editor does not support firmware upgrade for color type(GP-S070, LP-S070). Firmware upgrade of color type is available only by USB HOST.

- 1st Visit our homepage www.autonics.com to download a firmware file and save this file to USB memory.
- 2nd Connect USB memory to USB host of GP/LP, and call system setting menu.
- 3rd Select [DATA]-[FIRMWARE UPDATE].
- 4th Touch 'OK' and it starts firmware update.

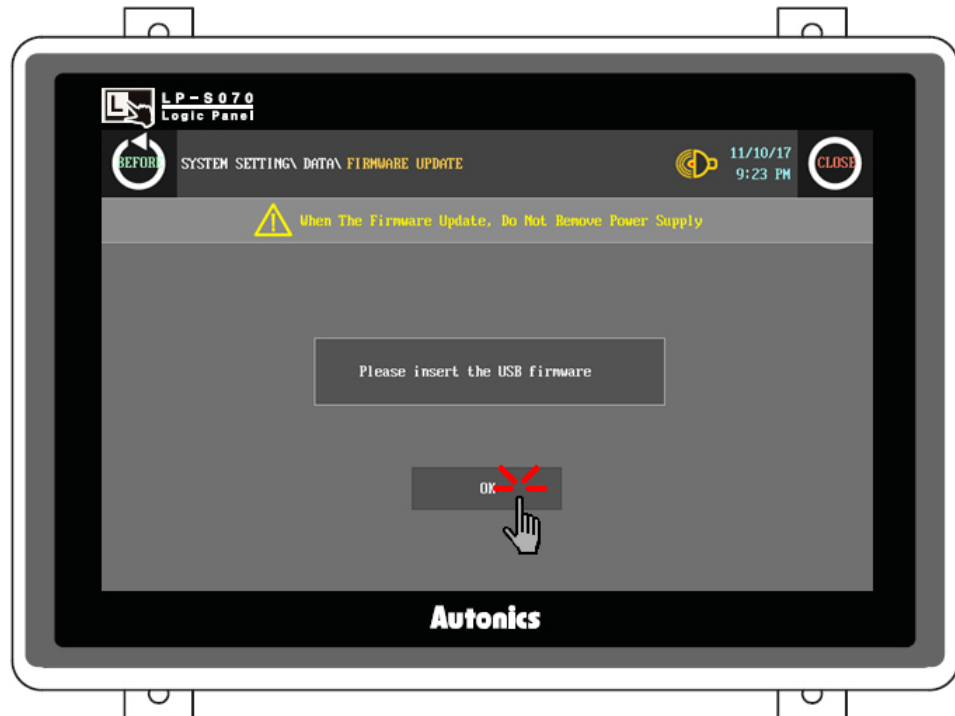

Note

After firmware upgrading, all of GP/LP user data are deleted.
Before upgrading firmware, select [Communication]-[Upload] of menu to save the desired data.

7.6 Option

Refer to '2.6.3 Communication'.

8 Common

8.1 Title

You can designate project ID, title, detail description to a project for convenient management of GP/LP and GP Editor. You can download or upload this information to GP/LP with GP Editor.

Each base or window screen also has title and detail description. You can download or upload this title to GP/LP with GP Editor. Detail description is not able to download to GP/LP.

Screen title is used for screen list at GP/LP.

8.1.1 Project title

Project Title	Description
①Project ID	Created with project. You can edit this from 1 to 4,294,967,295. When downloading project without deleting the existing project on GP/LP, if the existing project ID is not same as to be downloaded project ID, warning message appears.
②Project Title	Edit project title. This may be omitted or up to 32 characters can be entered.
③Detail Description	Edit project detail description. This may be omitted or up to 512 characters can be entered.
④Designer	Edit designer name. This may be omitted or up to 8 characters can be entered.

8.1.2 Screen title

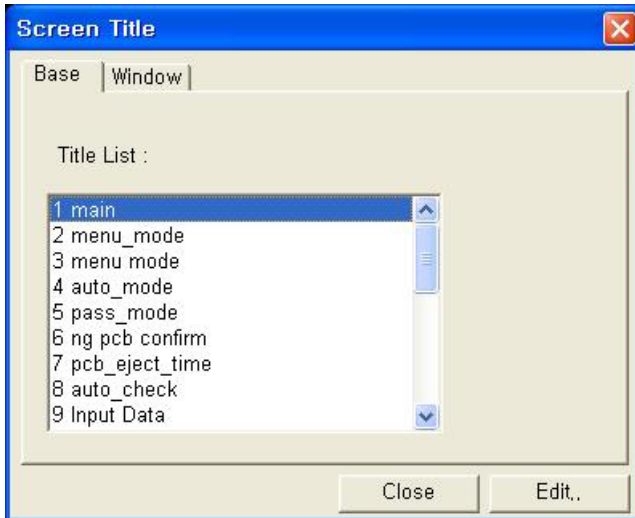

You can edit title and detail description of base or window screen. Double-click or select to be edited base or window screen and click 'Edit' and that base screen's 'Screen Title' dialog box appears.

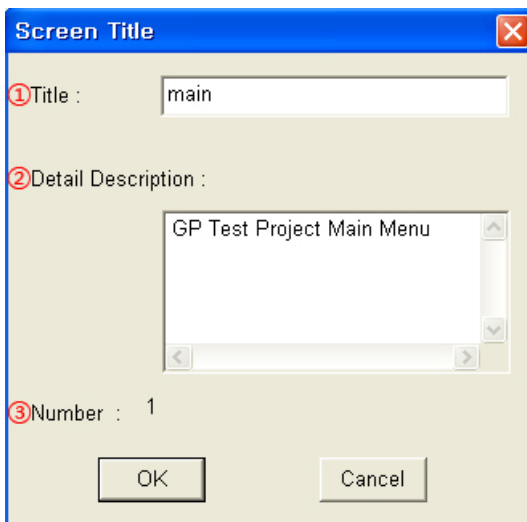

Screen Title	Description
① Title	Edit title of the current screen. This may be omitted or up to 32 characters can be entered. It is downloaded to real GP/LP memory.
② Detail Description	Edit detail description of the current screen. This may be omitted or up to 512 characters can be entered. It is not downloaded to GP/LP.
③ Number	Displays the current screen number.

8.2 GP/PLC Type

You should select the device which is connect with GP/LP when creating project at first. Select [Common]-[GP/PLC Type] of menu, 'GP/PLC Type' dialog box appears to change PLC type of the current project. When changing GP/PLC type, devices which are designated at project are automatically or manually changed.



Note

Restriction for changing PLC type: Changing GP/LP model is available only between same color type model. In other words, before mono type project is able to change only to mono type, color type project is able to change only to color type.

8.2.1 PLC connection

To operate correctly downloaded screen data in GP/LP, you should designate right PLC type at GP Editor.

Whenever creating a new project, 'GP/PLC Type' dialog box appears to designate GP/LP and PLC type.

When starting GP Editor, for not to appear 'Project Select' 'GP/PLC Type' dialog box; select [Project]-[Option] of menu and non-check 'Select project when program is started'. When starting GP Editor after this, GP and PLC type is designated automatically as the latest saved project's type. 'Project Select' and 'GP/PLC Type' dialog box does not appear. You can change GP/LP and PLC type in [Common]-[GP/PLC Type] of menu.

- Connection for PLC is different by PLC type, refer to 'GP, LP user manual for communication'.
- Every device such as PLC, etc is available to connect any RS232C or RS422 port.

8.2.2 Connecting PLC setting

To download data editing in GP Editor to PLC, you should designate connected PLC group, type, and communication type.

GP/PLC Type	Description
① GP/LP Type	Designate GP/LP model type by pull-down menu.
② CH1 Group	Designate PLC group of CH1 by pull-down menu.
③ CH1 Type	Designate PLC type of CH1 for ② by pull-down menu.
④ CH2 Group	Designate PLC group of CH2 by pull-down menu.
⑤ CH2 Type	Designate PLC type of CH2 for ④ by pull-down menu.

8.2.3 Convert device with changing PLC type

After changing PLC type in 'GP/PLC Type' dialog box and clicking 'OK', 'Convert Device' dialog box appears. The devices of current project (before converting device) are automatically converted to the device of changed PLC type project(after converting device).

Before converting and after converting devices are listed on 'Convert Device' dialog box by bit or word device. You can manually convert not automatically converted device.

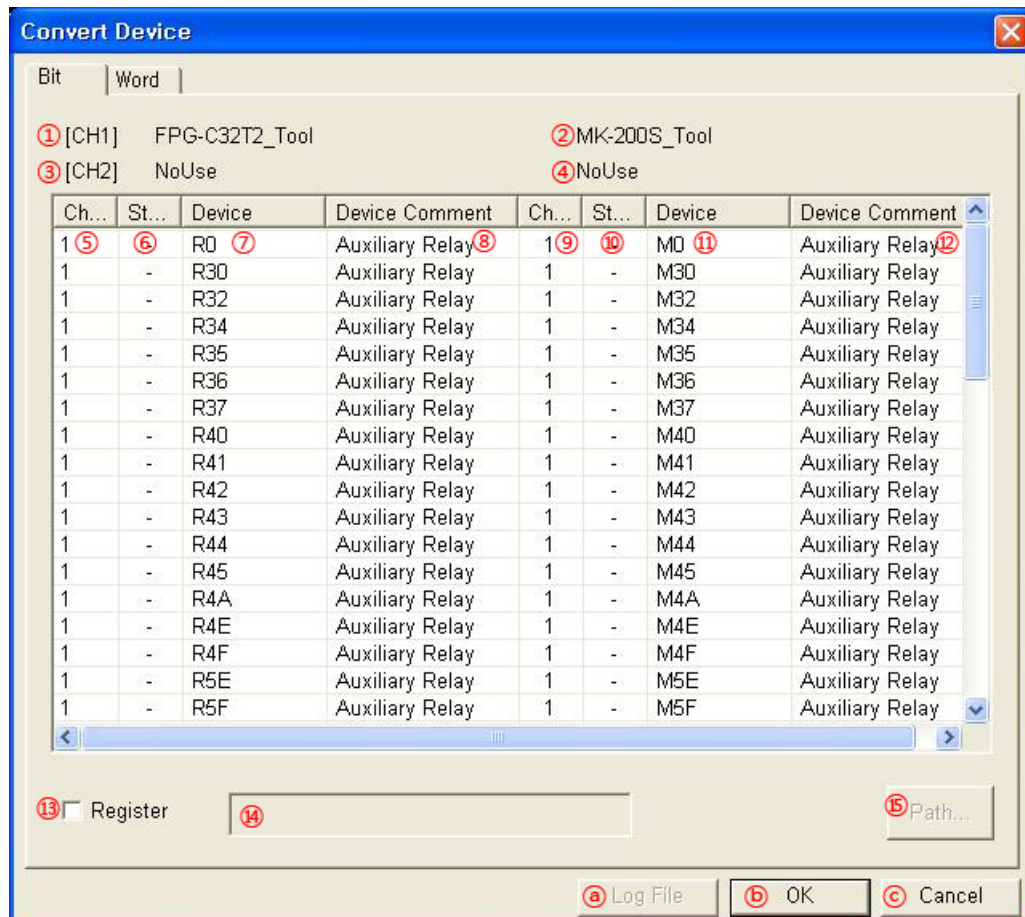

Convert Device	Description
① Before changing CH1 PLC	Displays before changing PLC type of CH1.
② After changing CH1 PLC	Displays after changing PLC type of CH1.
③ Before changing CH2 PLC	Displays before changing PLC type of CH2.
④ After changing CH2 PLC	Displays after changing PLC type of CH2.
⑤ Channel	Displays before converting device channel.
⑥ Station	Displays before converting device station.
⑦ Device	Displays the devices of current project (before converting device).
⑧ Device Comment	Displays device comment for each character of ⑦ Device.

Convert Device	Description
⑨ Channel	Displays after converting device channel.
⑩ Station	Displays after converting device station.
⑪ Device	Displays the device of changed PLC type project(after converting device) which corresponds to ⑦ Device. <ul style="list-style-type: none"> If there is not corresponded device to ⑦ Device, it displays '??'. You can enter and designate the corresponded device.
⑫ Device Comment	Displays device comment for each character of ⑪ Device.
⑬ Register	Designate saving changed list on dialog box as file or not. Checking this, you can designate to be saved file patch with activated ⑭, ⑮.
⑭ Path	Displays to be saved log file path.
⑮ Path...	Designate to be saved log file path.
Ⓐ Log File	Saves the list of 'Convert Device' dialog box as log file (text).
Ⓑ OK	Converts devices as the list, changes PLC type, and closes 'Convert Device' dialog box.
Ⓒ Cancel	Cancels changing PLC type, closes 'Convert Device' dialog box.



Ex.

Example of log file

- Bit device convert

Before converting	After converting
[CH1(----)] R0(auxiliary relay)	[CH1(----)] M0(auxiliary relay)
[CH1(----)] R1(auxiliary relay)	[CH1(----)] M1(auxiliary relay)
[CH1(----)] R2(auxiliary relay)	[CH1(----)] M2(auxiliary relay)
[CH1(----)] R3(auxiliary relay)	[CH1(----)] M3(auxiliary relay)

- Word device convert

Before converting	After converting
[CH1(----)] DT0(data register)	[CH1(----)] D0(data register)
[CH1(----)] DT1(data register)	[CH1(----)] D1(data register)
[CH1(----)] DT2(data register)	[CH1(----)] D2(data register)
[CH1(----)] DT3(data register)	[CH1(----)] D3(data register)
[CH1(----)] DT4(data register)	[CH1(----)] D4(data register)
[---(----)] UW20(LP word device)	[---(----)] UW20(LP word device)

8.3 Link Device

Generally GP/LP monitors directly PLC device of CH1. To link PLC device of CH1 and GP/LP connect device (by saving monitored PLC device value to specified GP/LP connect device), link device menu is needed.

Mono type must use link device with CH2 to communicate 1:N.

Color type is able to monitor directly PLC device of each channel (CH1,CH2). Therefore, color type does not use link device and is able to communicate 1:N without CH1, CH2 division. However, PLC which supports station is only able to communicate 1:N.

Select [Common]-[Link Device] of menu, 'Link Device Setting' dialog box appears.

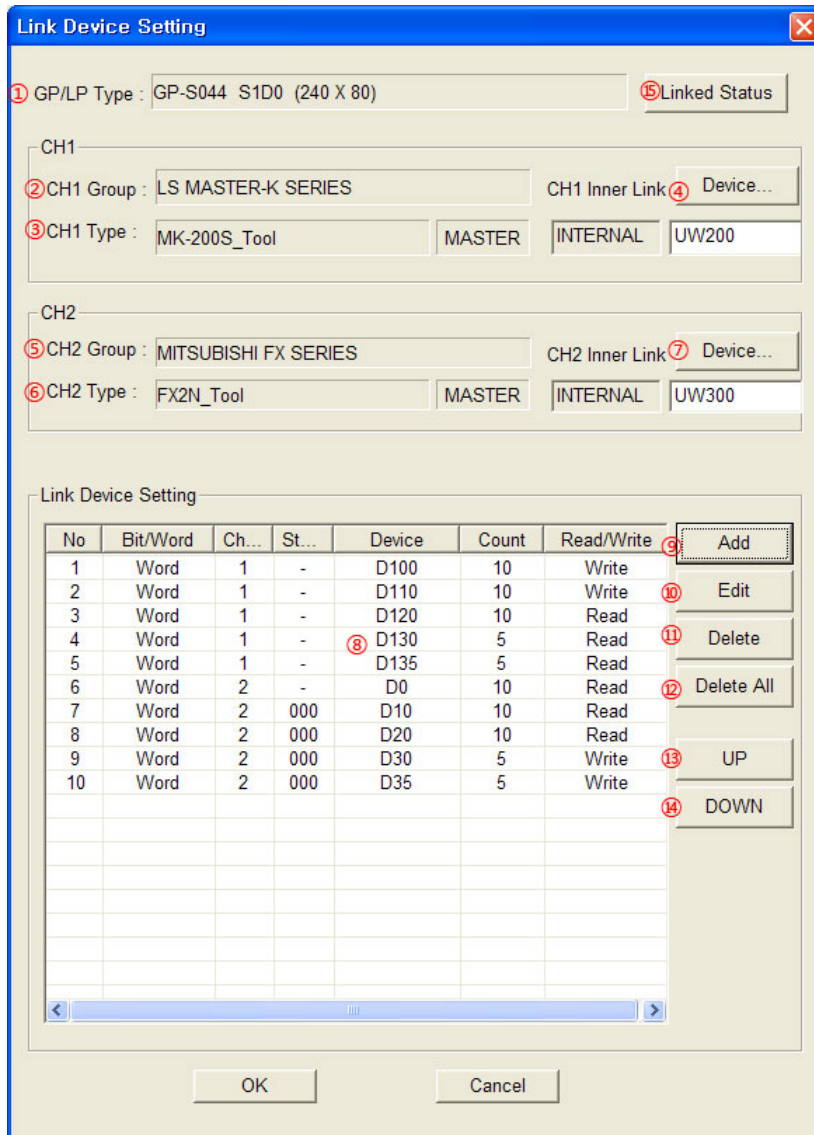

Link Device	Description
①GP/LP Type	Displays GP/LP model type.
②CH1 Group	Displays CH1 group.
③CH1 Type	Display PLC type of CH1 group.
④CH1 Inner Link Device	Designate lead word address of GP/LP for communication with CH1

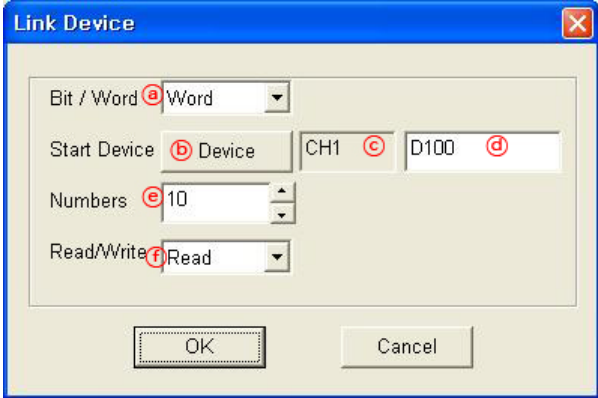
Link Device	Description
⑤ CH2 Group	Displays CH2 group.
⑥ CH2 Type	Displays PLC type of CH2 group.
⑦ CH2 Inner Link Device	Designate lead word address of GP/LP for communication with CH2.
⑧ Link Device Setting Status	Displays bit/word, channel, station, start device, count, read/write of CH1/CH2 to communicate with GP/LP
⑨ Add	<p>Adds link device settings. 'Link Device' dialog box appears.</p>  <p>① Bit/Word: Select bit/word device of PLC to communicate ② Start Device: Designate start device of PLC to communicate ③ Start Device: Displays selected channel at ② ④ Start Device: Displays selected device at ② ⑤ Numbers: Designate the number of read/write device from start device at ② ⑥ Read/Write: Set read/write operation for designated device Link device information by channel is able to register up to 5.</p>
⑩ Edit	Edit the selected item on ⑧ among set link device
⑪ Delete	Delete the selected item on ⑧ among set link device
⑫ Delete All	Delete all of set link device
⑬ UP	Moves up the item of set link device.
⑭ DOWN	Moves down the item of set link device.

Link Device	Description
⑮ Linked Status	<p>Displays table for link device setting of set between GP/LP and CH1, GP/LP and CH2.</p>

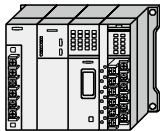
GP/LP	CH1 station	Communication direction	CH1 PLC
			
GP/LP Series	※1		MK-200S
UW200 to UW209	-	(Write) →	D100 to D109
UW210 to UW219	-	(Write) →	D110 to D119
UW220 to UW229	-	(Write) →	D120 to D129
UW230 to UW234	-	(Read) ←	D130 to D134
UW235 to UW239	-	(Read) ←	D135 to D139

※1. Mono type(GP-S044, GP-S057, LP-S044) is able to communicate 1:1 for CH1, and does not support multi station selection. It is fixed as the station of GP/LP and displays '-'.
 Color type(GP-S070, LP-S070) is able to communicate 1:1, 1:N for without CH1, CH2 division, and supports multi station selection. It is able to designate station. If PLC of connected with CH2 does not support station, it displays '-' and 1:N communication does not execute.

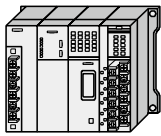
GP/LP	CH2 station	Communication direction	CH2 PLC
			
GP/LP Series	※2		FX-2N
UW300 to UW309	-	(Read) ←	D0 to D9
UW310 to UW319	-	(Read) ←	D10 to D19
UW320 to UW329	-	(Read) ←	D20 to D29
UW330 to UW334	-	(Write) →	D30 to D34
UW335 to UW339	-	(Write) →	D35 to D39

※1. Mono type(GP-S044, GP-S057, LP-S044) is able to communicate 1:1, 1:N for CH2 and supports multi station selection. If PLC of connected with CH2 does not support station, it displays '-' and 1:N communication does not execute.

Color type(GP-S070, LP-S070) is able to communicate 1:1, 1:N for without CH1, CH2 division, and supports multi station selection. If PLC of connected with CH2 does not support station, it displays '-' and 1:N communication does not execute.

In this case, UW(i) is 1st GP device, Dk(i) is 1st CH1 device.

(1) CH1 GP connect device: UW(i)

Link device setting

- Start Device: D1(i), Bit/Word: Word, Numbers: A, Read/Write: Write
- Start Device: D2(i), Bit/Word: Word, Numbers: B, Read/Write: Read
- Start Device: D3(i), Bit/Word: Word, Numbers: C, Read/Write: Read
- Start Device: D4(i), Bit/Word: Word, Numbers: D, Read/Write: Read
- Start Device: D5(i), Bit/Word: Word, Numbers: E, Read/Write: Write

GP Device(Word)	Data move	CH1
		Device
First A units of device from UW (i)	→	D1(i) to D1(i+A-1)
B units of device from the next	←	D2(i) to D2(i+B-1)
C units of device from the next	←	D3(i) to D3(i+C-1)
D units of device from the next	←	D4(i) to D4(i+D-1)
E units of device from the next	→	D5(i) to D5(i+E-1)

(2) CH1 GP connect device: UW (i)

Link device setting

- Start Device: D1(i), Bit/Word: Word, Numbers: A, Read/Write: Write
- Start Device: D2(i), Bit/Word: Bit, Numbers: B, Read/Write: Read
- Start Device: D3(i), Bit/Word: Word, Numbers: C, Read/Write: Read
- Start Device: D4(i), Bit/Word: Bit, Numbers: D, Read/Write: Read
- Start Device: D5(i), Bit/Word: Word, Numbers: E, Read/Write: Write

GP Device(Word)	Data move	CH1
		Device
First A units of device from UW (i)	→	D1(i) to D1(i+A-1)
[(B+16-1)/16] units of device from the next	←	D2(i) to D2(i+[(B+16-1)/16]-1)
C units of device from the next	←	D3(i) to D3(i+C-1)
[(D+16-1)/16] units of device from the next	←	D4(i) to D4(i+[(D+16-1)/16]-1)
E units of device from the next	→	D5(i) to D5(i+E-1)

GP device is always word. When CH1 link device is set as bit, it is linked as below.

1 to 16 units of CH1 bit device ↔ 1 unit of GP word device

17 to 32 units of CH1 bit device ↔ 2 units of GP word device



Ex.

- CH1 GP connect device: UW(30)
- Link device setting
 - Start Device: K(0), Bit/Word: Word, Numbers: 5, Read/Write: Write
 - Start Device: M(0), Bit/Word: Word, Numbers: 3, Read/Write: Write
 - Start Device: D(0), Bit/Word: Word, Numbers: 4, Read/Write: Read
 - Start Device: D(10), Bit/Word: Word, Numbers: 6, Read/Write: Write

GP		Data move	CH1	
Device(Word)	Numbers		Device	Numbers
UW(30) to UW(34)	5	→	K(0) to K(4)	Word 5
UW(35) to UW(37)	3	→	M(0) to M(2)	Word 3
UW(38) to UW(41)	4	←	D(0) to D(3)	Word 4
UW(42) to UW(47)	6	→	D(10) to D(15)	Word 6

- CH1 GP connect device: UW(30)
- Link device setting
 - Start Device: K(0), Bit/Word: Word, Numbers: 5, Read/Write: Write
 - Start Device: M(0), Bit/Word: Word, Numbers: 3, Read/Write: Read
 - Start Device: P(10), Bit/Word: Bit, Numbers: 20, Read/Write: Read
 - Start Device: D(10), Bit/Word: Word, Numbers: 6, Read/Write: Write

GP		Data move	CH1	
Device(Word)	Numbers		Device	Word
UW(30) to UW(34)	5	→	K(0) to K(4)	Word 5
UW(35) to UW(37)	3	→	M(0) to M(2)	Word 3
UW(38)	1	←	P(10) to P(13)	Bit 4
UW(39) to UW(44)	6	→	D(10) to D(15)	Word 6

If numbers is set over than usable numbers, maximum range numbers is used.

CH2 device is monitored indirectly with linked GP device. CH2 link device setting is same as CH1 data link and is able to connect multi devices and to set several stations.

In this case, D(i) is i_{st} GP device, N_Dk(i) is that station is N, Dk(i) is i_{st} CH2 device.

- CH2 GP connect device: D(i)
- Set for station and connect device

(3) Station N

- Start Device: N_D1(i), Bit/Word: Word, Numbers: A_N
- Start Device: N-D2(i), Bit/Word: Word, Numbers: B_N
- Start Device: N-D3(i), Bit/Word: Word, Numbers: C_N
- Start Device: N-D4(i), Bit/Word: Word, Numbers: D_N
- Start Device: N-D5(i), Bit/Word: Word, Numbers: E_N

GP/LP Device(Word)	Data move	CH2	
		Station	Device
First A_0 units of device from D(i)	Read/Write	0	0_D1(i) to 0_D1(i+A ₀ -1)
B_0 units of device from the next	Read/Write		0_D2(i) to 0_D2(i+B ₀ -1)
C_0 units of device from the next	Read/Write		0_D3(i) to 0_D3(i+C ₀ -1)
D_0 units of device from the next	Read/Write		0_D4(i) to 0_D4(i+D ₀ -1)
E_0 units of device from the next	Read/Write		0_D5(i) to 0_D5(i+E ₀ -1)
A_1 units of device from the next	Read/Write	1	1_D1(i) to 1_D1(i+A ₁ -1)
B_1 units of device from the next	Read/Write		1_D2(i) to 1_D2(i+B ₁ -1)
C_1 units of device from the next	Read/Write		1_D3(i) to 1_D3(i+C ₁ -1)
D_1 units of device from the next	Read/Write		1_D4(i) to 1_D4(i+D ₁ -1)
E_1 units of device from the next	Read/Write		1_D5(i) to 1_D5(i+E ₁ -1)
...
A_{31} units of device from the next	Read/Write	31	31_D1(i) to 31_D1(i+A ₃₁ -1)
B_{31} units of device from the next	Read/Write		31_D2(i) to 31_D2(i+B ₃₁ -1)
C_{31} units of device from the next	Read/Write		31_D3(i) to 31_D3(i+C ₃₁ -1)
D_{31} units of device from the next	Read/Write		31_D4(i) to 31_D4(i+D ₃₁ -1)
E_{31} units of device from the next	Read/Write		31_D5(i) to 31_D5(i+E ₃₁ -1)

If Bit/Word setting is Bit, CH1 link device has same link structure as bit's and communicates with GP/LP.



Ex.

- CH2 GP connect device: UW(30)
- Set for station and connect device

(4) Station 1

- Start Device: K(0), Bit/Word: Word, Numbers:5, Read/Write: Write
- Start Device: M(0), Bit/Word: Bit, Numbers:3, Read/Write: Write
- Start Device: D(0), Bit/Word: Word, Numbers:4, Read/Write: Read
- Start Device: D(10), Bit/Word: Word, Numbers:6, Read/Write: Write

(5) Station 3

- Start Device: K(10), Bit/Word: Bit, Numbers:2, Read/Write: Read
- Start Device: M(16), Bit/Word: Word, Numbers:5, Read/Write: Write

(6) Station 11

- Start Device: D(20), Bit/Word: Word, Numbers:7, Read/Write: Read
- Start Device: D(30), Bit/Word: Word, Numbers:2, Read/Write: Write
- Start Device: M(32), Bit/Word: Bit, Numbers:4, Read/Write: Write

GP/LP		Data move	CH2		
Device	Numbers		Station	Device	Numbers
UW(30) to UW(34)	5	→	1	K(0) to K(4)	Word 5
UW(35)	1	→		M(0) to M(3)	Bit 3
UW(36) to UW(39)	4	←		D(0) to D(3)	Word 4
UW(40) to UW(45)	6	→		D(10) to D(15)	Word 6
UW(46)	1	←	3	K(10) to K(11)	Bit 2
UW(47) to UW(51)	5	→		M(16) to M(20)	Word 5
UW(52) to UW(58)	7	←	11	D(20) to D(26)	Word 7
UW(59) to UW(61)	2	→		D(30) to D(31)	Word 2
UW(62)	1	→		M(32) to M(35)	Bit 4

8.4 System Information

8.4.1 Overview

It communicates always between read/write device of GP/LP and PLC device designated from 'System Information' dialog box of GP Editor. Depending on read device value, it controls GP/LP operation and depending on write device value, it monitors GP/LP state.

Select [Common]-[System Information] of menu, 'System Information' dialog box appears.

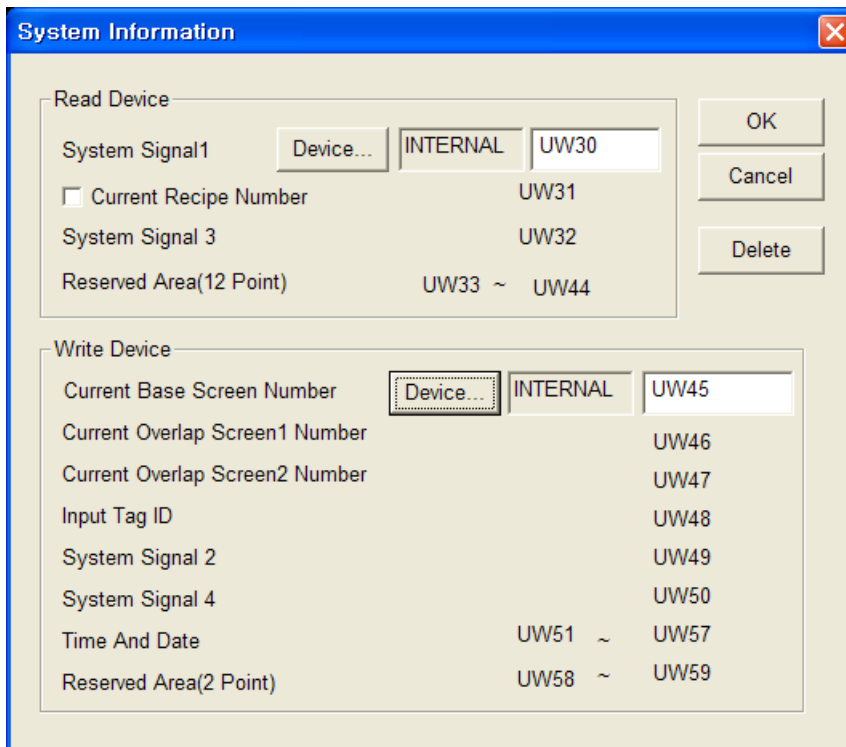

8.4.2 Read device

Reads PLC device in GP/LP, controls GP/LP.

Designate word device from 'System Information' dialog box of GP Editor.

(1) System Signal1

- Bit 0
It clears all alarm history (history and occurrence) when this bit is OFF→ON. When this bit is ON→OFF, it does not clear alarm history.
[Common]-[Alarm History] of menu has also same alarm history clear function. 'Alarm History Property' dialog box appears. Check 'Erase History' and designate device. Clear alarm history by setting the designated device which operates independently without this bit.
- Bit 1
Backlight is turned off after when this bit is OFF→ON and designated time in system setting is passed. Backlight is turned on when this bit is OFF again or you touch the screen. When this bit is ON state, backlight is operated and it is not operated in OFF state.
- Bit 2
When GP/LP and external device (CH1) is not connected, or there is connection problem, this bit is ON and displays error message.

- Bit 3
When GP/LP and external device (CH2) is not connected, or there is connection problem, this bit is ON and displays error message.
- Bit 4
[Disable signal for barcode input] When this bit is ON, it processes current read data from barcode reader as invalid data.
- Bit 5
[Complete signal for barcode input read] When this bit is ON, barcode input read is completed. Barcode reader is ready to receive new data. It switches complete signal for barcode input write as OFF when GP/LP→PLC.
- Bit 7
When this bit is ON, it switches complete signal for numeral input bit (Bit 4 of system signal 2) into OFF.



Note

For further details about Bit 4 and Bit 5, refer to '8.13 Barcode'.

(2) Current Recipe Number

You can designate recipe number to read and write among several files of recipe. Write several recipes in recipe and designate recipe number to this device. Send read/write trigger signal and each operation is occurred.
+1 address of designated word device from 'System Information' dialog box of GP Editor is allotted.



Note

For further details refer to '8.11 Recipe'.

(3) System Signal3

- Bit 0: Buzzer control
Buzzer is ON for ON state, buzzer is OFF for OFF state.
- Bit 4: Backlight control
Backlight is OFF for ON state, backlight is ON for OFF state.
- Bit 5: Print control
It starts to print alarm when it is changed as OFF→ON.

(4) Reserved Area(12Point)

It is reserved area to add system signal.

8.4.3 Write device

It monitors GP/LP state with reading GP/LP device of PLC.

(1) Current Base Screen Number. (Write Device)

It writes current screen number of GP/LP.
When you switches screen, this device value is changed as switched screen number.

(2) Current Overlap Screen1 Number (Write Device+1)

It writes overlap window 1 screen number of GP/LP to the designated PLC device from 'System Information' dialog box. +1 address of designated word device from 'System Information' dialog box of GP Editor is allotted.

(3) Current Overlap Screen2 Number (Write Device+2)

It writes overlap window 2 screen number of GP/LP to the designated PLC device from 'System Information' dialog box. +2 address of designated word device from 'System Information' dialog box of GP Editor is allotted.

(4) Input Tag ID (Write Device+3)

If there is the screen which has numeral input or ASCII input tag, it saves user ID of input tag which completed input at this device. +3 address of designated word device from 'System Information' dialog box of GP Editor is allotted.

(5) System Signal2 (Write Device+4)

- Bit 0
This bit is ON when at least one alarm monitor bit is ON. Even if screen is moved and alarm monitor bit is ON, this bit preserves the state.
- Bit 4: ON when numeral input is completed
This bit is ON when for numeral input or ASCII input tag input value is input normally. It is not reset automatically, you should reset at PLC program separately.
- Bit 8: Barcode input signal
This bit is set when barcode input write data from GP/LP to PLC is completed.
- Bit C
This bit is set when battery is low reading voltage state of backup battery.

(6) System Signal4 (Write Device+5)

- Bit 0: Flag of alarm print (1 for printing, 0 for the other)
- Bit 5: 0.5 sec clock
- Bit 6: 1 sec clock
- Bit 7: 2 sec clock
- Bit 8: Communication port 1 frame error
- Bit 9: Communication port 1 parity error
- Bit A: Communication port 1 overrun error
- Bit C: Communication port 2 frame error
- Bit D: Communication port 2 parity error
- Bit E: Communication port 2 overrun error

(7) Time And Date (7 POINTS)**(8) Reserved Area (2 POINTS)**

It is reserved area which user cannot use.

8.4.4 GP inner device**(1) System Information (UW0 to UW29)**

When designating the device from 'System Information' dialog box of GP Editor, this device and GP/LP inner device UW0 to UW29 shares same value.

UW area	Read area	Write area
UW0		Displayed screen number in GP/LP.
UW1		Displayed overlap1 screen number in GP/LP
UW2		Displayed overlap2 screen number in GP/LP
UW3		User ID number of input tag
UW4		System signal 2
UW5		System signal 4

UW area	Read area	Write area
UW6		Clock sec (second)
UW7		Clock min (miniute)
UW8		Clock hour (time)
UW9		Date day (day)_
UW10		Date month (month)
UW11		Date year (year)
UW12		Date a day of week
UW13		Write reserved area
UW14		Write reserved area
UW15	System signal 1	
UW16	Current recipe number	
UW17	System signal 3	
UW18 to UW29	Read reserved area	

(2) UW30 to UW2047

It is used as general data register.

(3) UW2048 to UW6047

It is used as general data registration, however, it is required to notice for using recipe.

UW area	Read area	Write area
UW30	User area	User area
...	User area	User area
...	User area	User area
UW2047	User area	User area
UW2048	User area(Recipe using area)	
...		
...		
UW6047		

8.5 Switch Screen

8.5.1 Basic operation

This function is for that a base screen or overlap screen switches by designated word device value. For switching a base screen, one device register must be allotted. Therefore data register is allotted as default. Switching overlap window is available up to two for option, overlap window 1, 2 are overlapped successively on a base screen.

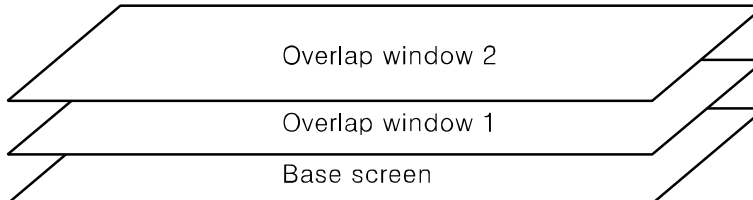

8.5.2 Property



Switch Screen	Description
① Base screen device	Calls 'Device Select' dialog box to designate device for switching base screen.
② Device	Designated device saves current displayed screen number. If changing this device value, base screen switches into the changed device base screen. Data register is allotted as default and you can change it. GP inner device UW20 is designated as default.
③ Overlap Window 1	Check this for using overlap window 1. The specified base screen is overlapped depending on the designated word device value. If both overlap window 1 and 2 are checked, overlap window 2 is always placed on overlap window1. When it is overlapped, it is affected on security configuration of the specified screen and it is overlapped when it is canceled. It displays allowed security level objects and it does not display over allowed security level object.
④ Device	Designate word device for switching overlap window 1 screen.
⑤ Device	If changing this device value, overlap window 1 screen switches into the changed device value screen.
⑥ Overlap Window 2	Check this for using overlap window2. The specified base screen is overlapped depending on the designated word device value.
⑦ Device	Designate word device for switching overlap window 2 screens. If
⑧ Device	changing this device value, overlap window 2 screen switches into the changed device value screen.

Switch Screen	Description
⑨ Do not initialize screen switching device	<p>This is for saving basic screen, overlap screen 1,2, and screen number when downloading data. Designate initializing PLC device value or not.</p> <p>Checking this, GP/LP maintains the set ②, ⑤, ⑧ Device value when downloading the set value by GP Editor.</p> <p>Not-checking this, GP/LP initializes each ②, ⑤, ⑧ Device value to 1, 0, and 0 when downloading the set value by GP Editor.</p>

8.6 Security

Only allowed user can monitor important data and edit it to designate password to each base screen and system screen. User should input correct password to allow to the desired screen which has security.

8.6.1 Basic usage

- 1st From the screen to be set security, select [Common]-[Auxiliary Configuration]-[Screen] of menu. 'Screen Auxiliary Property' dialog box appears. Or click right mouse button, pop-up menu appears. Select 'Screen' and 'Screen Auxiliary Property' dialog box appears.
- 2nd Designate 'Security Level' as over 1.
- 3rd Security level is from 0 to 15. The screen which security level is 0 is available to anyone without inputting password.
- 4th Select [Common]-[Security] of menu, 'Security' dialog box appears. You can designate password by each security level.
- 5th Double-click the level to be set password or select the level and click 'Edit' in 'Security' dialog box.
- 6th 'Password' dialog box appears. Input the desired password.
- 7th Click 'OK' and '*****' is displayed next to the level to be set password in 'Level Password' box of 'Security' dialog box.
- 8th Click 'Close' and complete security setting.



Note

To see the screen which is set security level in GP/LP, the password which is for this security level or higher level should be inputted and security is released.

For example, if you input password for security level 5, you can edit the screen which have security level 5 or below. However, you cannot edit the screen which have security level 6 or higher.

(1) Calling key window for inputting password

- Touch touch key with function key (FFA6) and key window for inputting password appears.
- When switching into the screen which has higher security level than the released security level, key window appears automatically.

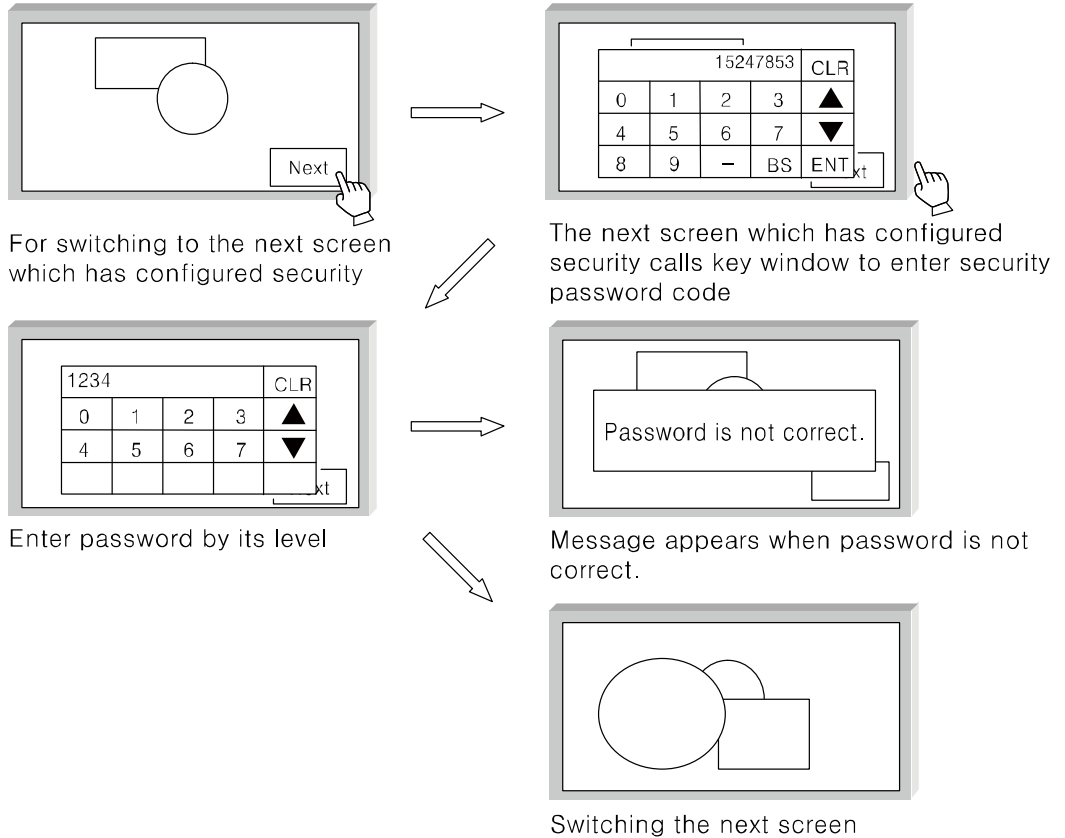

※1. Password code appears when key window for password is called, it is encoded about the top level password. When you forgot the password, send this code to Autonics and we will inform you about the password.

(2) Reset security

Touch touch key with function key (FFAD) and reset security. When switching into the screen which is released security, input password again.

(3) Security from system setting

You can designate security not to edit important settings from system setting menu in GP/LP. System setting's each below menu is able to be set security. If trying to enter the other menu which is set security, key window for inputting password appears. Input correct password. If wrong password is inputted, you cannot enter the desired menu.

(4) Overlap for the screen set security

When switching into base screen which has overlap screen, the screens which have higher security level than the base screen's level are not displayed. The screen which has same security level or below level is displayed only.

When designating security level and password in GP Editor as following, it operates with switching screen in GP/LP.

Screen	Security level	Password
Base screen 1	0	--
Base screen 2	1	11
Base screen 3	2	22
Base screen 4	3	33

- Overlaps base screen 2, 3 to base screen 1 in GP Editor;
If you calls base screen 1 in GP/LP, only base screen is displayed.
- Overlaps base screen 2, 4 to base screen 3 in GP Editor;
If you calls base screen 3 in GP/LP, key pad appears automatically. Enter password for the security level of base screen 3. Base screen 3 which is overlapped base screen 2 is displayed.

(5) Security for upload/memory function

For using upload/memory function of GP Editor, it is able to designate that only allowable user can use these functions by inputting password.

8.6.2 Property

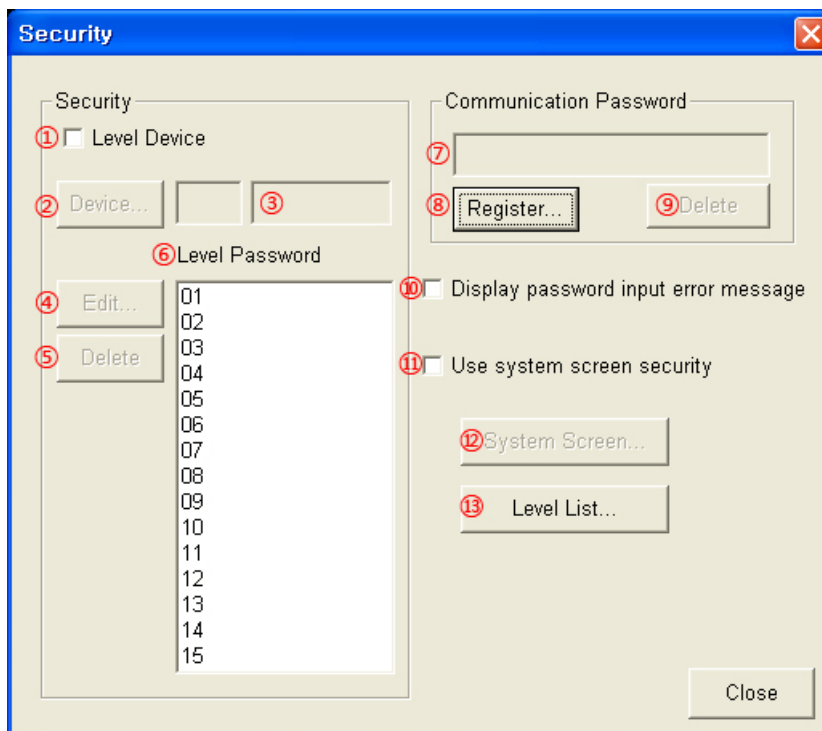

Security	Description
① Level Device	Check this to use level device which saves currently released top security level. Displayed with numeral display on the screen for checking security level of the current screen. If security levels from 1 to 15 do not have password, this device value is 0. For example, security level 10 has password, this device value is 10.
② Device	Calls 'Device Select' dialog box and designate level device.
③ Device	Input device directly or displays the designated device

Security	Description
④ Edit	<p data-bbox="523 282 1334 309">Calls 'Password' dialog box and edit to the selected security level at ⑥.</p>  <p data-bbox="523 613 1251 674">Password is only numbers within 8 characters. If there is designated password, input correct password to edit it.</p>
⑤ Delete	<p data-bbox="523 696 1126 723">Deletes password of the selected security level at ⑥.</p> <p data-bbox="523 734 1278 761">If there is designated password, input correct password to delete it.</p>
⑥ Level Password List	<p data-bbox="523 786 1398 869">Displays that there is password for each security level from 1 to 15. If there is password, it displays '*****' regardless of digit at right side of each level.</p> <p data-bbox="523 880 1362 963">Each base screen is able to have security level from 0 to 15 from 'Security Auxiliary Configuration' dialog box. Each password for the level is only numbers within 8 characters.</p> <ul data-bbox="523 974 1385 1104" style="list-style-type: none"> • Security level 0: You can see the screen which has security level 0 anytime without password. • Security level 1 to 15: You should input password for the security level of the screen or higher level to see the screen which has security level 1. <p data-bbox="523 1115 1326 1142">Every security is reset when power is resupplied with released security.</p>
⑦ Communication Password	<p data-bbox="523 1162 1155 1189">Displays '*****' if there is password for communication.</p> <p data-bbox="523 1200 1358 1249">For using upload/memory function, you should input password. 'Password Input' dialog box Appears automatically.</p>
⑧ Register	<p data-bbox="523 1267 1058 1294">Register password for upload/memory function.</p> <p data-bbox="523 1305 1251 1332">If there is designated password, input correct password to edit it.</p>
⑨ Delete	<p data-bbox="523 1346 1390 1395">Deletes password for communication. If there is designated password, input correct password to delete it.</p>
⑩ Display password input error message	<p data-bbox="523 1424 1401 1485">Designate displaying password input error message in GP/LP when password is not correct.</p>
⑪ Use system screen security	<p data-bbox="523 1529 1158 1556">Checking this, security function for system screen is set.</p> <p data-bbox="523 1568 1321 1617">Non-checking, this, it does not use security function for system screen. Therefore security level for system screen is 0.</p>
⑫ System Screen	<p data-bbox="523 1635 1366 1765">Activated only with checking ⑪ Use system screen security. Calls 'Screen Auxiliary Property' dialog box with 'System Screen' tab. Select the desired screen and click 'Edit' and 'Configure Security Level' dialog box appears to edit security level.</p> <p data-bbox="523 1776 1326 1825">The default security level of system screen is 15 and you can edit each system screen's security level.</p> <p data-bbox="523 1836 1406 1912">If there are not set password for top level from 1 to 15, 'Level Password' tab of 'Data Check' dialog box at [Communication]-[Check Data] of menu appears to check.</p>

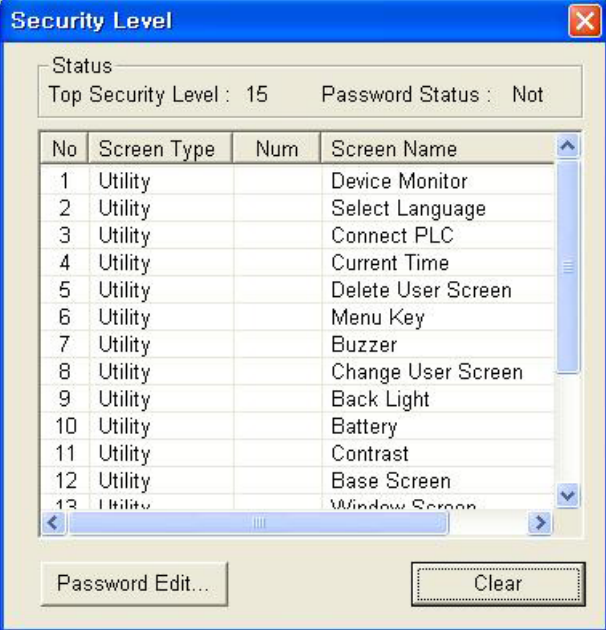
Security	Description
<p>⑬ Level List</p>	<p>Check that there is password for top security level.</p>  <ul style="list-style-type: none"> ▪ If there is not the base screen which has security level any from 1 to 15, and ⑩ Use system screen security is not checked, it does not use security function. ▪ If there is the base screen which has security level any from 1 to 15, and ⑩ Use system screen security is not checked, only base screen uses security function. If there is not password for top security level of base screen, error message appears before downloading.
<p>⑭ Close</p>	<p>Saves settings and closes 'Security' dialog box.</p>

8.7 Comment

Comment is commonly used for alarm history, alarm list, and comment display, etc. Comment list is for up to 2,000 and every saved list is able to download to GP/LP. Maximum list is 2,000 but be sure that capacity of memory for download has limit. You can check comment at system menu in GP/LP.

Comment color for alarm history, alarm list, and comment display is not set from each tag, but is set from comment list.

Comment list is saved as text file, and you can register comment list from comment list of text file. Select [Common]-[Comment] of menu, 'Comment List' dialog box appears. You can edit about the comment.

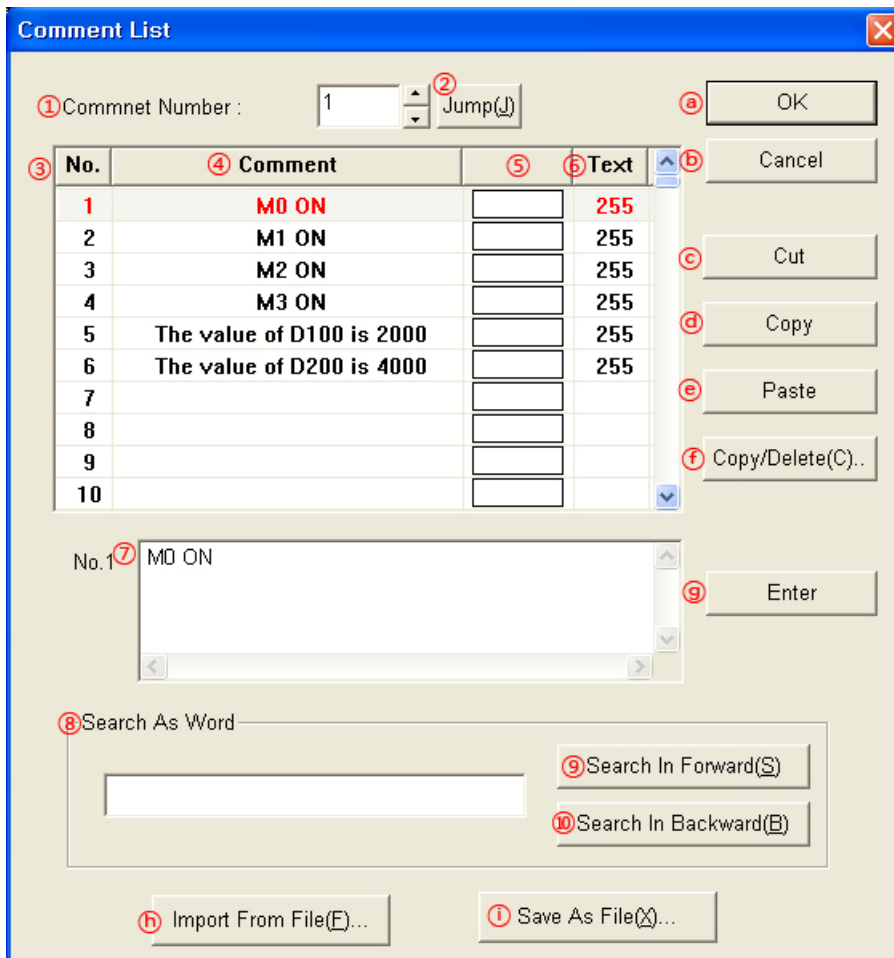

Comment List	Description
① Comment Number	Input to jump comment number.
② Jump	Jumps to input comment number at ⑥. Jumped comment number is listed at first to scroll the list.
③ No.	Displays comment number.
④ Comment	Displays comment content.
⑤,⑥ Text Color	Displays comment text color.
⑦ Input Comment	Input comment content.

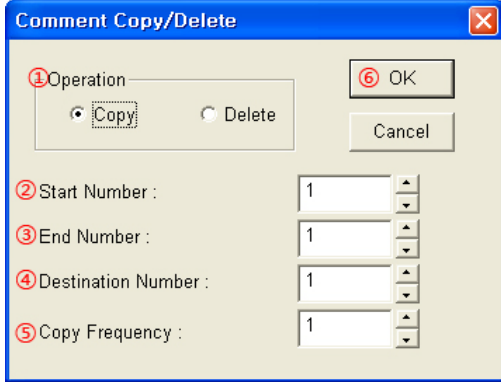
Comment List	Description
⑧ Search As Word	Input the desired comment to search.
⑨ Search In Forward	Search the comment which is same as the input comment at ⑧ with higher comment number direction than currently selected number. The searched comment is listed at first to scroll the list.
⑩ Search In Backward	Search the comment which is same as the input comment at ⑧ with below comment number direction than currently selected number.
Ⓐ OK	Saves current setting, closes 'Comment List' dialog box.
Ⓑ Cancel	Does not save current setting, closes 'Comment List' dialog box.
Ⓒ Cut	Cuts selected item.
Ⓓ Copy	Copies selected item.
Ⓔ Paste	Pastes copied or cut selected item.
Ⓕ Copy/Delete	<p>This function is to copy or delete several comments on the list subsequently. 'Comment Copy/Delete' dialog box appears.</p>  <p>① Operation: Copy, Delete</p> <p>② Start Number: Start number of to be copied/deleted item.</p> <p>③ End Number: End number of to be copied/deleted item.</p> <p>④ Destination Number: Destination number to be copied.</p> <p>⑤ Copy Frequency: Number of copy frequency</p> <p>Ⓔ OK: ① Operation is 'Copy': Copies comments of from start number to end number to from destination number comment with the designated copy frequency subsequently.</p> <p>① Operation is 'Delete': Deletes comments of from start number to end number.</p>
Ⓖ Enter	Registers input comment content at ⑦ to comment list.
Ⓗ Import From File	Registers comment list from comment list of text file or XML file.
① Save As File	Saves comment list as text file or XML file

**Ex.**

When saving comment list, text file form;

```
//Comment number  
'Comment content',  
Color,0,0,0,0
```

```
comment - Notepad  
File Edit Format View Help  
//1  
"Comment 1",  
T16777215,0,0,0,0  
//2  
"Comment 2",  
T16777215,0,0,0,0  
|
```

8.8 Alarm History

Alarm history is feature for recording alarm history. It is able to record occurred time, restored time, the number of frequency by designating. You can print alarm list by connecting serial printer, check it by uploading to PC. Alarm history is the object which can exist only one on a screen.

8.8.1 Alarm history property

8.8.1.1 Basic tab

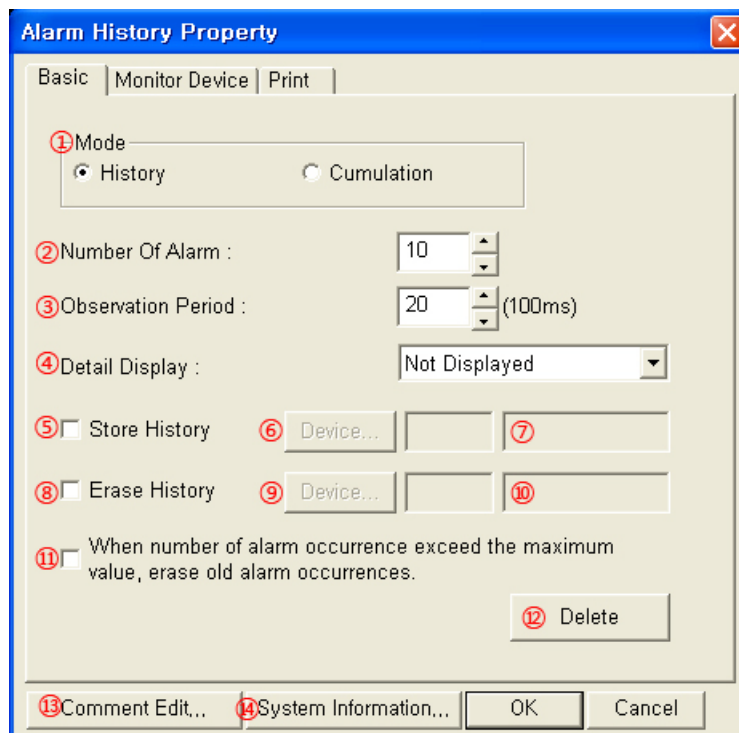

Basic	Description
① Mode	<ul style="list-style-type: none"> History: Displays the date and time of ON and the specified comment. Cumulation: Displays history mode content and occurrence frequency.
② Number Of Alarm	Designate the number of monitored bit device. Range is 1 to 256. When designating the lead device in 'Monitor Device' tab, later bit device is monitored object.
③ Observation Period	Designate monitor period cycle. Range is 600ms(6) to 80sec(8000) with 100ms interval.
④ Detail Display	<p>Designate detail display type by pull-down menu. Displays detail screen with base or window screen depending on the setting of touch key for detail screen display with key code FFA6H.</p> <ul style="list-style-type: none"> Not Displayed: Does not display detail screen. Comment Window: Displays detail screen as comment window form. Move alarm history cursor to view detail screen and touch detail screen view touch key, designated comment window screen appears as window. The specified alarm's comment appears at window. Base Screen: Move alarm history cursor to view detail screen and touch detail screen view touch key, designated base screen for detail screen appears. It is able to return to the previous screen after confirming detail information to place switch touch key for previous screen.

Basic	Description
⑤ Store History	Check this to designate save device for saving the number of current occurring alarm. Register at ⑦ Device not stored alarm of currently occurring alarms.
⑥ Device	Calls 'Device Select' dialog box and designate word device for saving the number of occurred alarm.
⑦ Device	Input device directly or displays the designated device for saving the number of occurred alarm.
⑧ Erase History	Designate bit device for deleting alarm history and the number of alarm frequency. Every alarm history and the number of alarm frequency are deleted when designated bit device at ⑩ turns ON. During that time, any alarm is not registered.
⑨ Device	Calls 'Device Select' dialog box and designate device for delete current alarm list.
⑩ Device	Input device directly or displays the designated bit device.
⑪ When number of alarm occurrence exceed the maximum value, erase old alarm occurrences.	Check this for delete the oldest alarm when alarm history is over 1024 to register new alarm. Non-checking this, when alarm history is over 1024, it is not able to register new alarm anymore. Activated only with history mode, not activated with cumulating mode.
⑫ Delete	Deletes all designated values at 'Alarm History Property' dialog box, sets as default value and closes this dialog box.
⑬ Comment Edit	Calls 'Comment List' dialog box and edit the registered comment list.
⑭ System Information	Calls 'System Information' dialog box and edit the information of alarm history

8.8.1.2 Monitor device tab

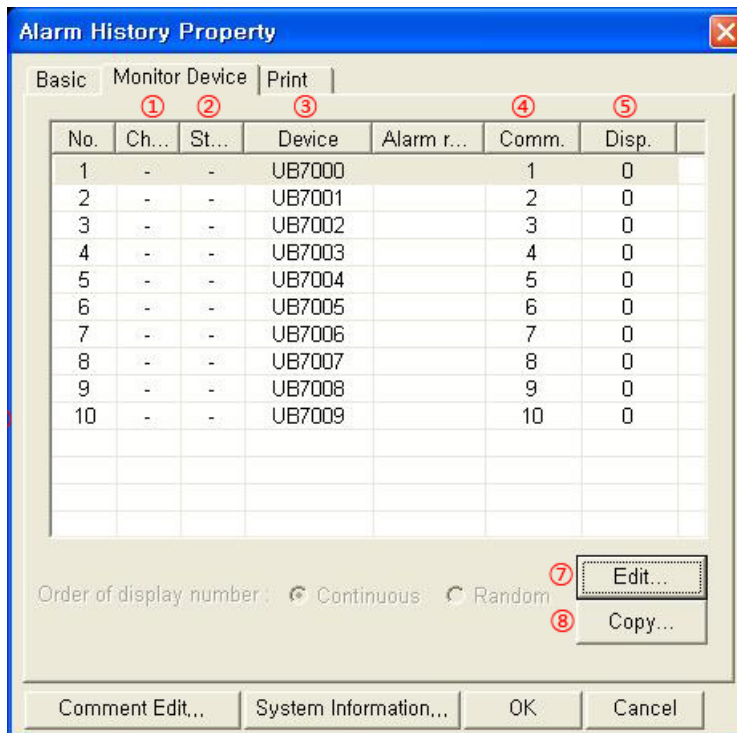

Monitor Device	Description
①Channel	Displays monitored bit device channel
②Station	Displays monitored bit device station
③Device	Displays monitored bit device Bit devices are displayed by then designated number of bit device in 'Basic' tab. Click 'Edit' to edit device and comment number of the device.
④Comment	Displays to be recorded comment number when alarm occurs (same line device is ON).Select the desired number and click 'Comment Edit' to edit the comment.
⑤Display	Displays comment number or base screen number for displaying detail screen. If detail display of 'Basic' tab is 'Comment Window', it displays comment number. If detail display is 'Base Screen', it displays base screen number.
⑥Order of display number	Activated only with when detail display of 'Basic' tab is 'Comment Window' or 'Base Screen'. Designated displaying comment number of base screen number continuously for detail screen or not. <ul style="list-style-type: none"> Continuous: Comment number or base screen number is designated continuously. Random: Click 'Edit' and designate detail screen/comment number as desired.
⑦Edit	Calls 'Edit' dialog box to designate monitor device, comment/display number, and device reset.

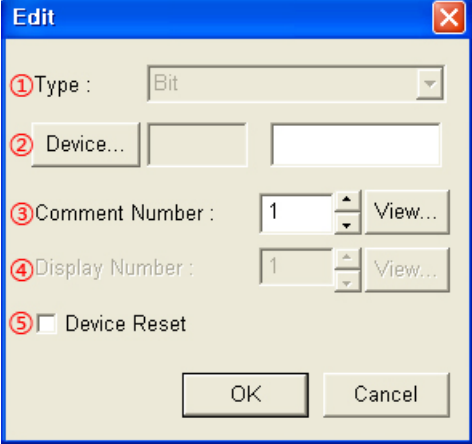
Monitor Device	Description
	 <p>Designate lead device for alarm history and 'Edit' dialog box appears with all activated items. When selecting devices of after lead device, only 'Device Reset' item of 'Edit' dialog box is activated to set individually. If 'Order of display number' is set as random and selecting devices of after lead device, 'Device Number' is also activated to set individually.</p> <p>①Type: It is fixed as Bit. (It does not support word device.)</p> <p>②Device: Set lead bit device for monitoring.</p> <p>③Comment Number: Designate comment number to be displayed. Click 'View' and 'Comment List' dialog box appears. You can check the registered comment and designate comment number.</p> <p>④Display Number: Designate display number at ④Comment. If 'Detail Display' of 'Basic' tab is as 'Comment Window', this number is for displaying comment window when touching detail screen touch key. Click 'Browse' and 'Comment List' dialog box appears to check registered comment and designate comment number. If 'Detail Display' of 'Basic' tab is as 'Base Screen', this number is for switched base screen number when touching detail screen touch key. Click 'Browse' and 'Screen Image' dialog box appears to check drawn base screen and designate screen number.</p> <p>⑤Device Reset: The device which has checked this is reset when touching the touch key with FFAAH.</p>
⑧ Copy	<p>Designates device reset and copies properties of ⑤Display. Calls 'Copy' dialog box. Designate source number item and check device reset or display number to copy that properties at destination number item with copy frequency.</p>

8.8.1.3 Touch key for alarm history

Cursor control to select specified line displaying detail information in basic function of alarm history is used with appropriate key code configuration and arranging on screen.

Key code	Function	Description
FFA4h	Show cursor	When touching touch key with key code FFA4, it is displayed as top of alarm list is selected when there is an alarm in alarm list screen.
FFA5h	Hide cursor	When touching touch key with key code FFA5, alarm list cursor does disappeared.
FFABh	Move cursor upward	When touching touch key with key code FFAB, upper item of currently selected is changed as selected state.
FFACh	Move cursor downward	When touching touch key with key code FFAC, below item of currently selected is changed as selected state.
FFA8h	Erase the alarm in cursor	When touching touch key with key code FFA8, currently selected item is deleted.
FFA9h	Erase all restored alarm	When touching touch key with key code FFA9, restored alarm list is deleted.
FFA6h	Calls detailed alarm information	When touching touch key with key code FFA6, detail screen [window comment or base screen] of selected item is displayed.
FFAAh	Reset device	When touching touch key with key code FFAA, if reset device for monitor device is ON and the specified alarm list item is selected during listing alarm history, the device is reset.

- Show cursor (FFA4h)

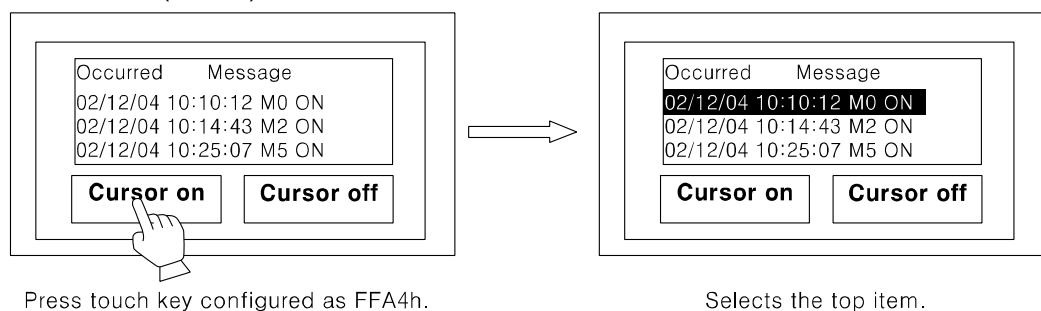

- Hide cursor (FFA5h)

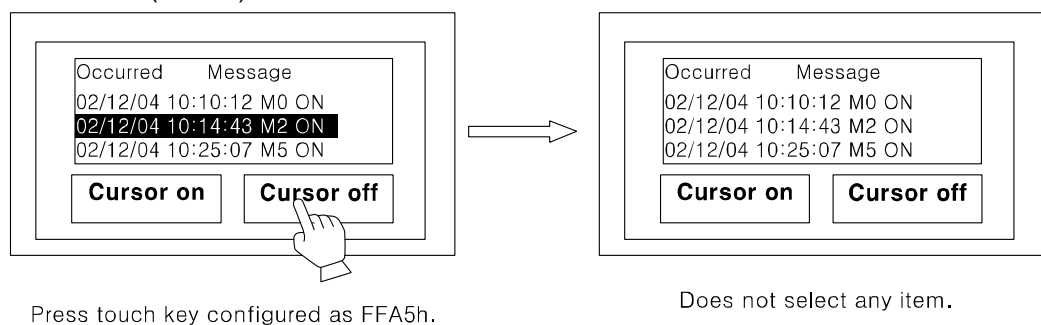

▪ Move cursor upward (FFABh)

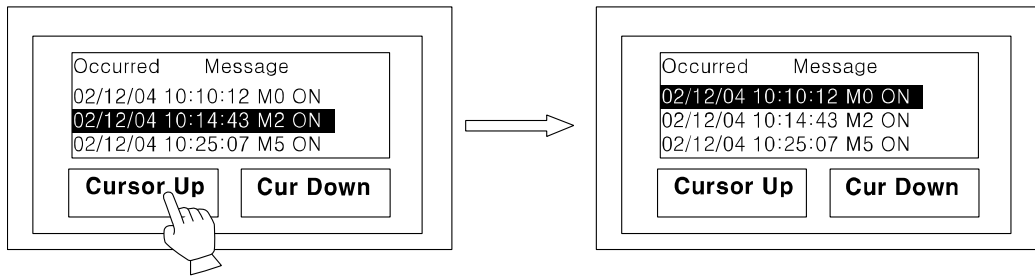

Press touch key configured as FFA6h.

Selects the one upper item.

▪ Move cursor downward (FFACh)

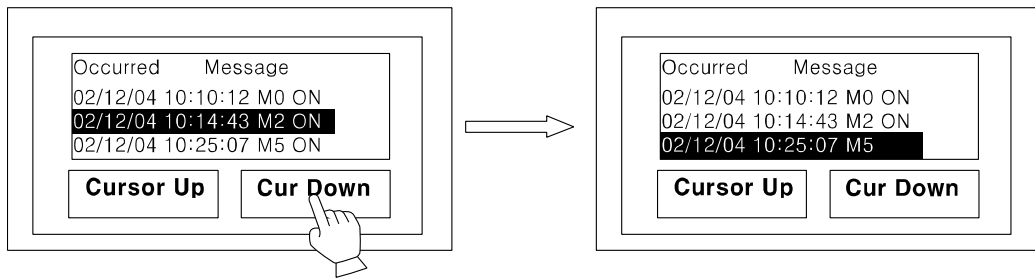

Press touch key configured as FFA7h.

Selects the one lower item.

▪ Erase the alarm in cursor(FFA8h)

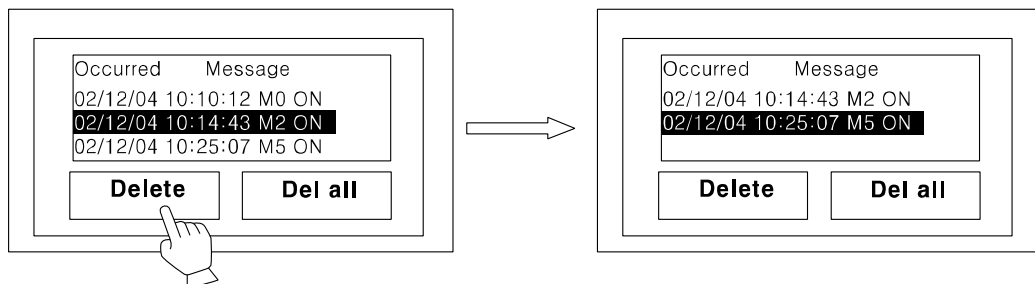

Press touch key configured as FFA8h.

Deletes the selected item which is restored alarm.

▪ Erase all restored alarm (FFA9h)

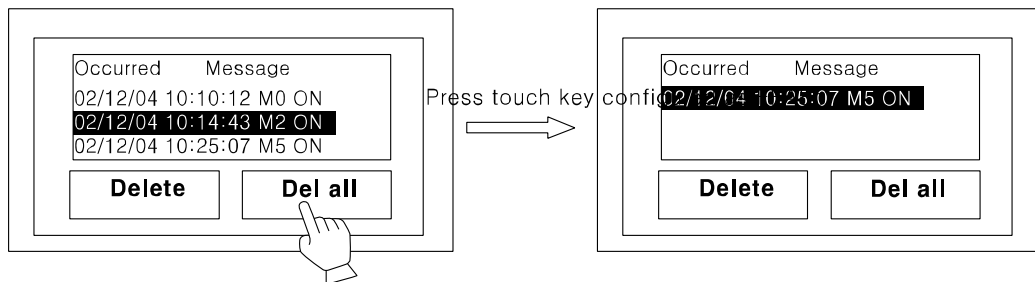

Press touch key configured as FFA9h.

Deletes all restored alarm item.

▪ Calls detailed alarm information(FFA6h)

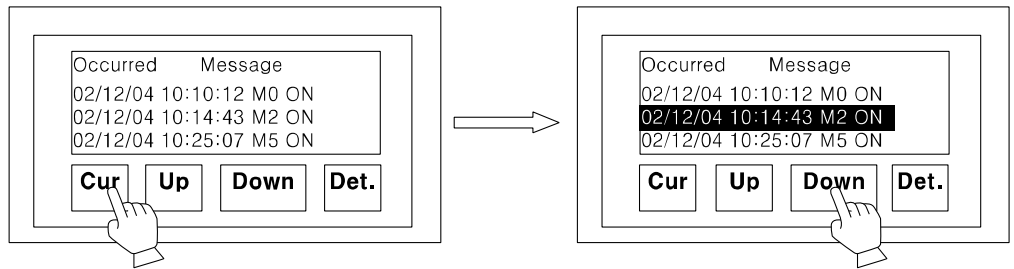

Display cursor with cursor display key.

Select item to read detail information with Up/Down key.

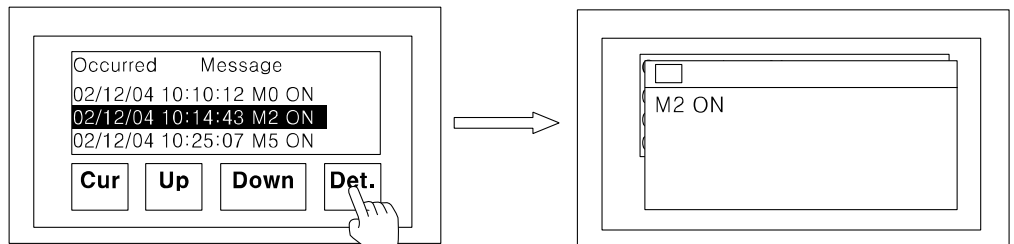

Press detail key(FFA6h).

Detail screen is comment window,

Detail screen is base screen,

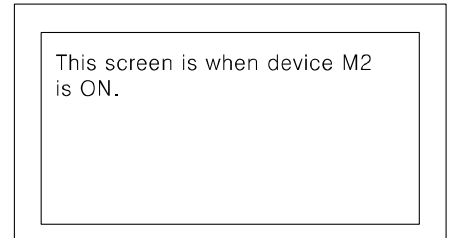

▪ Reset device (FFAAh)

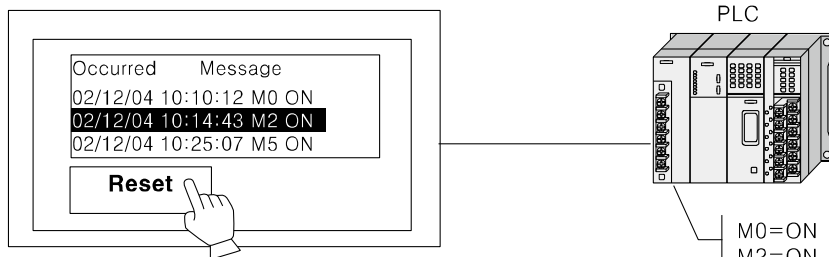

In status of selecting alarm configured to reset in editor configuration, press touch key configured as FFAAh.

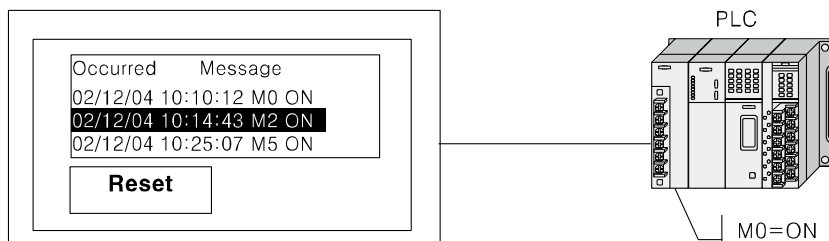

Alarm device M2 is changed as OFF status.

8.9 Floating Alarm

8.9.1 Basic operation

When the designated alarm device(Bit device) is ON state, the specified comment is displayed as designated font size moving right to left at the bottom of the screen.

When alarm is released (OFF), comment does disappears. ASCII character with up to 512 is displayed in a line, it moves as width font size unit and is displayed on a object in screen.

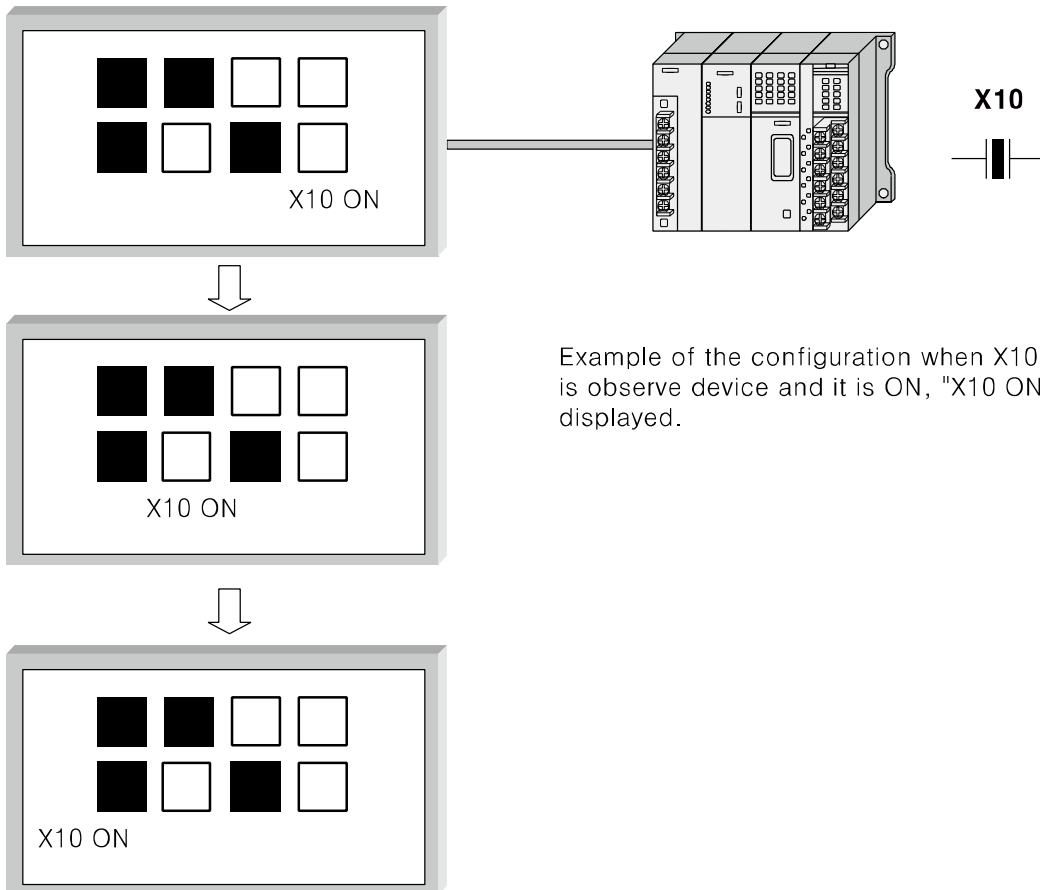

8.9.2 Property

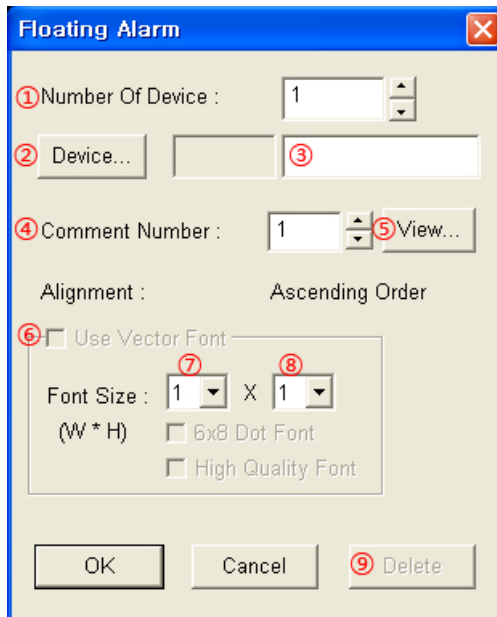

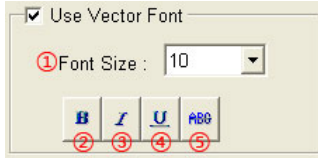
Floating Alarm	Description
①Number Of Device	Designate the number of monitored bit device. Range is 1 to 256.
②Device	Designate lead device of monitored bit device.
③Device	Input device directly or displays the designated device. From designated device, devices are subject to monitor as the number of device.
④Comment Number	Designate displayed comment number when lead device is ON. When device is ON, to be displayed comment corresponds in this number successively.
⑤View	Calls 'Comment List' dialog box and displays registered comment on project. Select the desired comment number to be input at ④Comment Number.
⑥Use Vector Font	Activated only for color type (GP-S070, LP-S070). Non-checking this, it uses bitmap font. Checking this, it displays as following.  ①Font size, ②Bold font, ③Italic font, ④Underline, ⑤Strikethrough
⑦Font Size (Width)	Designate width font size of comment by pull-down menu. ▪ Range: 1,2,3,4,
⑧Font Size (Height)	Designate height font size of comment by pull-down menu ▪ Range: 1,2,3,4,
⑨Delete	Deletes all designated values at 'Floating Alarm' dialog box and closes this dialog box.

8.9.2.1 Allow floating alarm

To operate floating alarm, you should designate it as following. Select [Common]-[Auxiliary Configuration]-[Screen] and 'Screen Auxiliary Property' dialog box appeared. Click 'Edit' and 'Screen Auxiliary Configuration' dialog box appears. Check 'Allow Floating Alarm' to operate floating alarm.

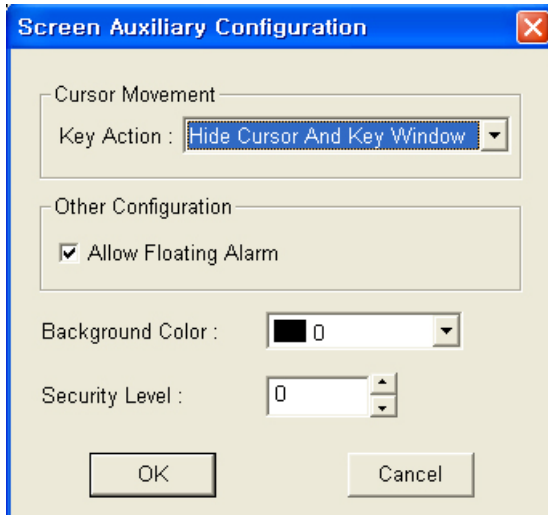

8.10 Monitor Status

Monitor status function is to monitor ON/OFF state of designated bit device (monitor device). Depending on that state it turns ON/OFF bit device of PLC or inputs numeral value to specified word device.

Select [Common]-[Monitor Status] and 'Monitor Status' dialog box appears. You can designate about monitor status such as monitor device, observe period, and operation for trigger, etc. However, this menu is activated only with when GP/LP type is set as GP series from 'GP/PLC Type' dialog box of [Common]-[GP/PLC Type]. This menu is not available to LP series.

8.10.1 Basic action

There are two monitor functions to whole project or to the specified screen.

- Monitors to project function
Regardless currently displayed screen in GP, monitors the designated monitor device. If it satisfies trigger conditions, it executes the set operation.
- Monitors to screen function
If currently displayed screen in GP is set monitor, monitors the designated monitor device. If it satisfies trigger conditions, it executes the set operation.

8.10.2 Execution order

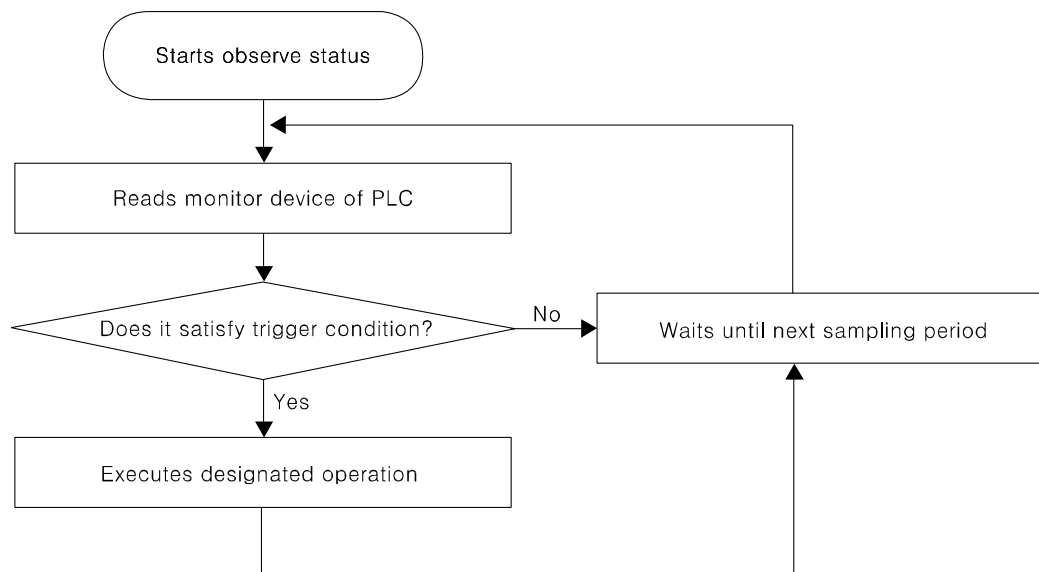

1st GP reads monitor device of designated PLC.

2nd Determines whether monitor device satisfies trigger conditions or not. (GP inner)

3rd If it satisfies trigger conditions, sets the specified bit device, or word device value.
(GP→PLC)

4th Waits next sampling cycle.

Repeats 1st to 4th execution.

If it satisfies trigger conditions at the point of previous sampling time, it skips designated operation for current time. When trigger conditions are lasted during successive sample section, designated operation executes in the first sample. For momentary action which maintains momentary ON the device only when it satisfies trigger conditions, device is turned ON from OFF by PLC program or forced input.

8.10.2.1 Action

When monitor device is satisfied trigger condition, action is divided as bit or word.

(1) Bit action

Bit action has four kinds operation.

- ① Set: Turns ON the device when trigger occurs.
- ② Reset: Turns OFF the device when trigger occurs.
- ③ Alternate: Alternates the current state of designated device when trigger occurs.
- ④ Momentary: Maintains momentary ON the designated device only when trigger occurs.

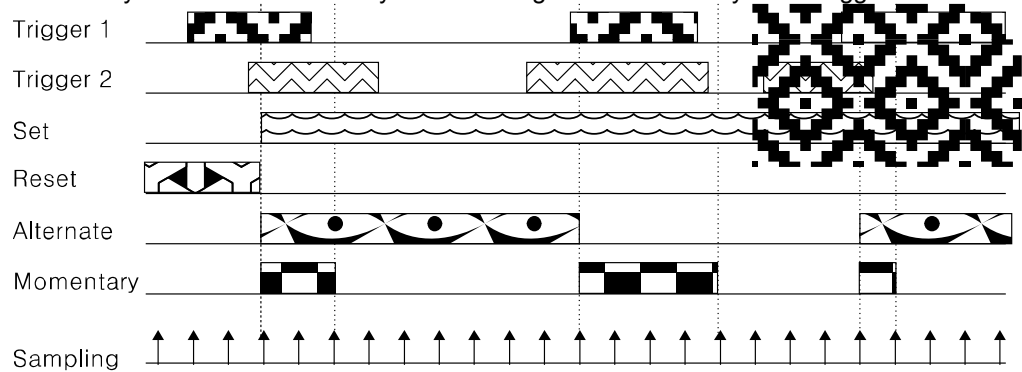

The above feature is for device state with sampling at set, reset, alternate, momentary action. Trigger 1, and trigger 2 display two trigger device state. When both is ON, it satisfies trigger conditions.



Ex.

Below feature is for the monitor operation to turn ON Y0 device when two bit trigger devices as M100, M101 is both ON.

GP screen has the lamp for Y0 state. At the first feature, both M100 and M101 are OFF state, it does not satisfy trigger conditions and the lamp for Y0 does not turn ON. When both M100 and M101 are ON, it satisfies trigger conditions, and the lamp for Y0 turns ON.

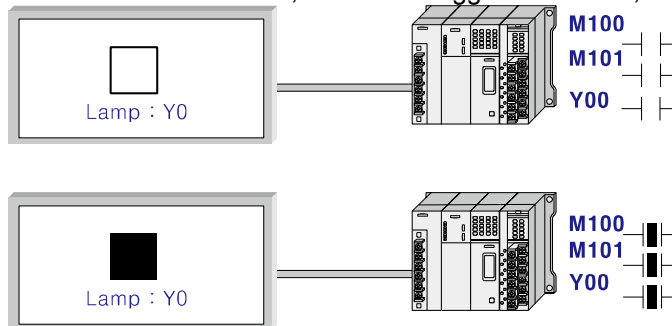

(2) Word action

- 1) 16 bit word setting: Assigns the value to 16 bit word device.
- 2) 32bit word setting: Assigns the value to 32 bit word device.

You can designate this as fixed value or as indirect using device.



Ex.

Example of setting indirect: In case, designated trigger device as M100(ON), Fixed value=10, Indirect device=D50 for M100. When M100 in ON, D50 value + 10 is set at D100.

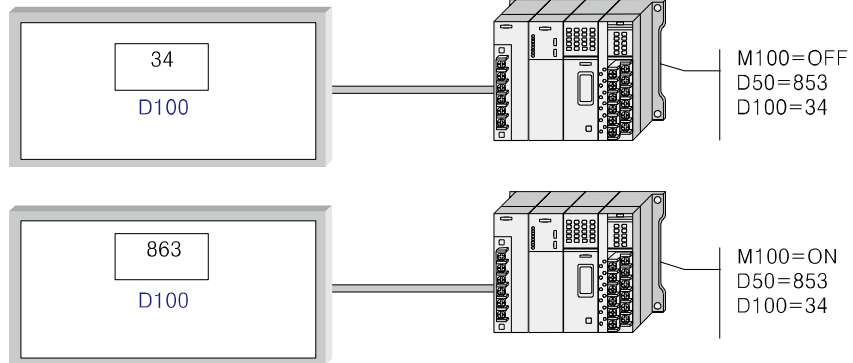

8.10.3 Property

- When trigger occurs, the number of save device point for monitoring at each project and screen is 40 by a project, 40 by a screen. Therefore, monitor trigger is total 80.
- When designating monitor bit device as screen unit, monitor bit of called overlap screen at base screen does not operated, designated monitor bit at base screen operates only.
- For window screen, state monitor function is not available.

8.10.3.1 Project tab

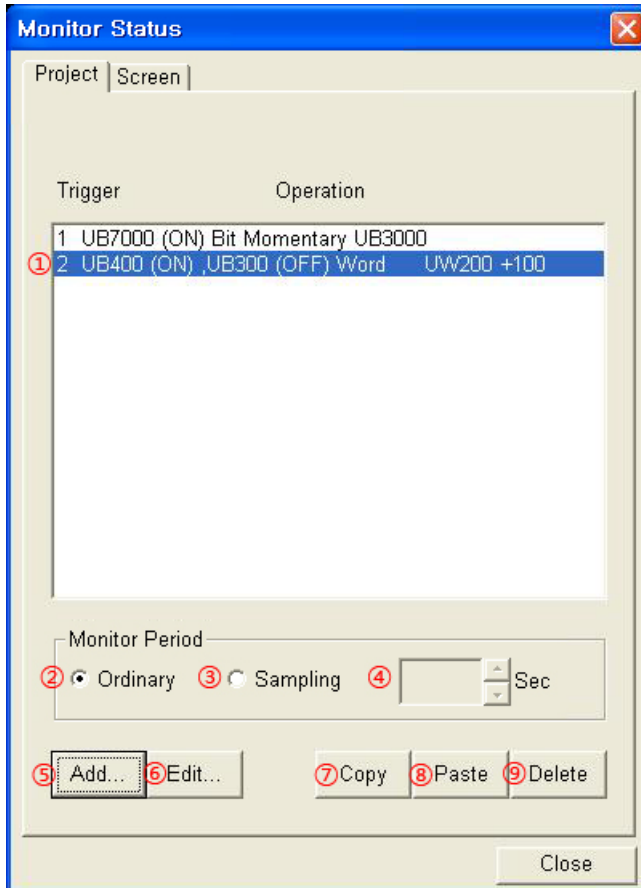

Project	Description
① Trigger/Operation	Displays currently designated trigger/operation.
② Ordinary	Operates monitor one time with minimum cycle which is able in system.
③ Sampling	Operates monitor with user-defined time cycle at ④.
④ Sampling	Activated only with selected ③. Default is 1 and range is from 1 to 60 sec by 1 sec.
⑤ Add	Calls 'Trigger/Action' dialog box and add trigger/action up to 40.
⑥ Edit	Calls 'Trigger/Action' dialog box and edit the selected item.
⑦ Copy	Copy the selected item.
⑧ Paste	Paste copied item to end number of this list.
⑨ Delete	Deletes selected trigger/action on the list.

8.10.3.2 Screen tab

The descriptions of 'Screen' tab is almost same as 'Project' tab's. The designation of 'Project' tab is regardless of GP screen. But the designation about monitor operation of 'Screen' tab is for currently displayed screen in GP. The monitor operation for other screens does not execute. Therefore, 'Screen' tab has 'Base Screen' setting.

- Base Screen

Designate the base screen number to apply monitor operation. You can select base screen number to input with spin box or to click 'View'. 'Screen Image' dialog box appears to select the desired base screen.

8.10.3.3 Trigger tab

Click 'Add' or 'Edit' in 'Monitor Status' dialog box, and 'Trigger/Action' dialog box appears. Set the trigger device and trigger conditions. You can set each individual trigger conditions for two bit device.

If both trigger 1, 2 are set, it operates the designated function when both conditions are satisfied at the same time. You should set trigger 1, but setting trigger 2 is not necessary.

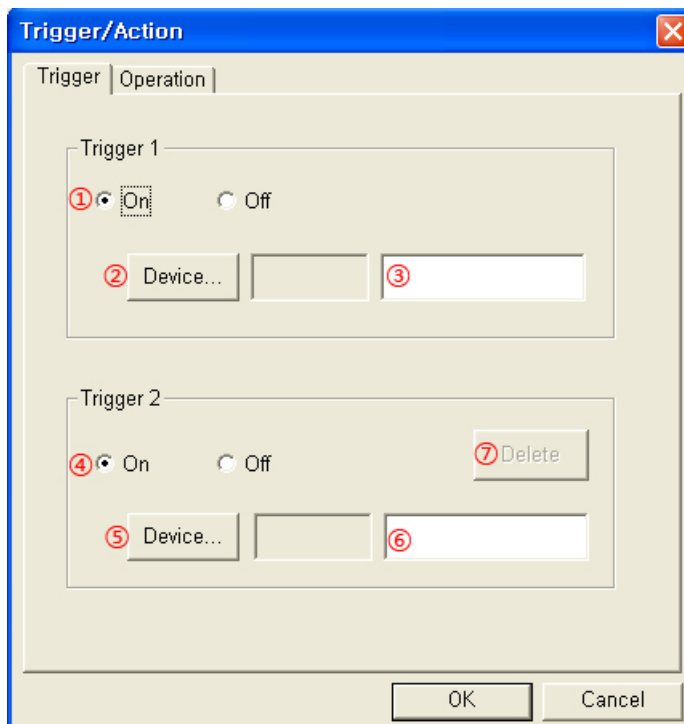

Trigger	Description
① Trigger1	Designate trigger state (On or Off) of trigger 1.
② Device	Calls 'Device Select' dialog box and designate trigger 1 device.
③ Device	Input device directly or displays the designated trigger 1 device.
④ Trigger2	Designate trigger state (On or Off) of trigger 2.
⑤ Device	Calls 'Device Select' dialog box and designate trigger 2 device.
⑥ Device	Input device directly or displays the designated trigger 2 device.
⑦ Device	Sets as trigger 2 is not designated.

8.10.3.4 Operation tab

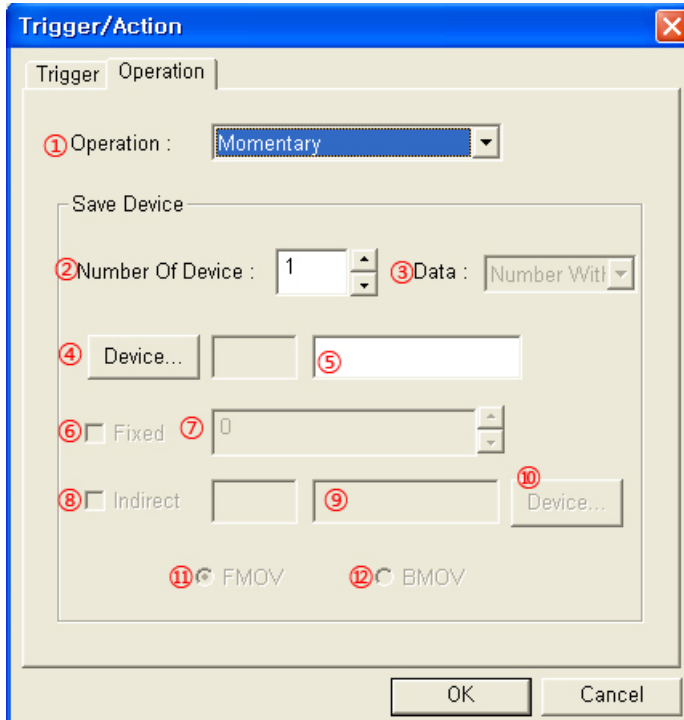

Operation	Description
① Operation	<p>Designate the operation for occurring trigger by pull-down menu.</p> <ul style="list-style-type: none"> ▪ Momentary: Maintains momentary ON the bit device only when trigger is satisfied trigger condition. ▪ Set: Turns ON the bit device when trigger occurs. ▪ Reset: Turns OFF the bit device when trigger occurs. ▪ Alternate: Alternates the current state of the bit device when trigger occurs. ▪ Word Configuration(16bit): Sets the value to 16 bit word device. ▪ Word Configuration(32bit): Sets the value to 32bit word device.
② Number of Device	<p>Designate the number of device which this setting is applied. From designated device at ④, designated operation operates as the number of device continuously.</p> <p>[Limit the number of device]</p> <ul style="list-style-type: none"> ▪ Bit device: 40 ▪ 16bit word device: 20 ▪ 32bit word device: 10
③ Data	<p>Activated only when operation is set 'Word Configuration(16bit)' or 'Word Configuration(32Bit)'.</p> <ul style="list-style-type: none"> ▪ Number With Sign: Device value is set as number with sign. ▪ Number Without Sign: Device value is set as number without sign. <p>For word device, depending on connected device type, it may use only 32bit. Refer to 'GP, LP user manual for communication'.</p>
④ Device	<p>Designate the device for operation.</p> <p>If operation is for bit device, 'Device Select' dialog box for bit appears, or for word device, 'Device Select' dialog box for word appears.</p>
⑤ Device	<p>Input device directly or displays the designated device</p>

Operation	Description
⑥Fixed	<p>Activated only with when operation is for bit device. Check this to designate specified word device as fixed value when trigger occurs.</p> <p>Ex) Set operation for trigger with non-checking ⑧Indirect and setting as ⑤Save device= D100, ⑦Fixed value=64, ②Number of device=4:</p> <p>D100 ← 64 D101 ← 64 D102 ← 64 D103 ← 64</p>
⑦Fixed	<p>Activated only with when operation is for word device and with checking ⑥. Designate fixed value to be saved at word device when trigger occurs.</p>
⑧Indirect	<p>Activated only with when operation is for word device. Check this to set the specified word device same as any device value when trigger occurs. Adds the current value of indirectly designated word device to set fixed value and saves it at the designated word device.</p> <p>⑦Fixed+⑨Indirect device value → ⑤Save device Indirectly designated device's type depends on operation device type. For example, save device is designated as 32 bit word device, indirectly designated device's type is also set as 32 bit type.</p>
⑨Indirect	<p>Input device directly or displays the designated indirect device.</p>
⑩Device	<p>Calls 'Device Select' dialog box and designate indirect device.</p>
⑪FMOV	<p>Activated only with when operation is for word device and ②Number of Device is set over than 2. Adds the current value of indirectly designated device to fixed value and saves at all save devices.</p> <p>Ex) ⑦Fixed=100, ⑨Indirect=D100, ⑤Save Device= D200(16bit), ②Number Of Device =3 Write operation when trigger occurs; D100 ← The value of 100 +D100 D101 ← The value of 100 +D100 D102 ← The value of 100 +D100</p>
⑫BMOV	<p>Activated only with when operation is for word device and ②Number of Device is set over than 2. The operation to add the current value of indirectly designated device to fixed value and to save at all save devices is same as FMOV. However, BMOV is that creating serial device as the number of point from indirectly designated device as lead device.</p> <p>Ex) ⑦Fixed =100, ⑧Indirect=D100, ⑤Save Device=D200(16Bit), ②Number Of Device=3 Write operation when trigger occurs; D200 ← 100(Fixed value)+D100 D201 ← 100(Fixed value)+D101 D202 ← 100(Fixed value)+D102</p>

8.11 Recipe

It reads or writes several PLC devices at once.

Read or write is operated by read or write trigger.

This recipe function transmits volumes of data to device with a write operation and saves volumes of PLC inner device value to recipe area device of GP/LP with a read operation.

- GP recipe area device: UW2048 to UW6047
- LP recipe area device: UW2048 to UW6047

8.11.1 Basic operation

- Select [Common]-[System Information] of menu, 'System Information' dialog box appears. Designate the device for 'System Signal1' and check 'Current Recipe Number'.
- Creates each recipe file
You can create recipe file from 1 up to 256. Recipe file name is up to 32 character of ASCII character and recognition of recipe file in GP/LP is not by recipe file name but recipe file number. You can designate recipe file name as a convenient.
- Designates read/write trigger device
You can designate each read/write trigger. If you do not use recipe read function, you do not need to designate read trigger. However, you should designate write trigger.
- Designates conditions for read/write trigger
You can set ON or OFF. When ON is set, trigger occurs in rising edge of trigger device. When OFF is set, trigger occurs in falling edge of trigger device.
- Designates save device
You can set only 16 bit word device as save device up to 4,000 per one recipe. Except of first recipe, the number of device and read/write trigger setting of other recipe file are fixed as the setting of first file's. You can edit only device and device data type, and device initial value.

8.11.1.1 Execution order

1st Reads read/write device of PLC.

2nd Confirms read/write trigger.

3rd If read/write trigger occurs, it reads recipe device and recipe file number. Operates read/write operations for the specified file.

(1) Recipe read operation

Reads all of each PLC device registered recipe file and set the specified device value to recipe area device.

(2) Recipe write operation

Sets all PLC devices registered recipe file to recipe area device as each saved value.

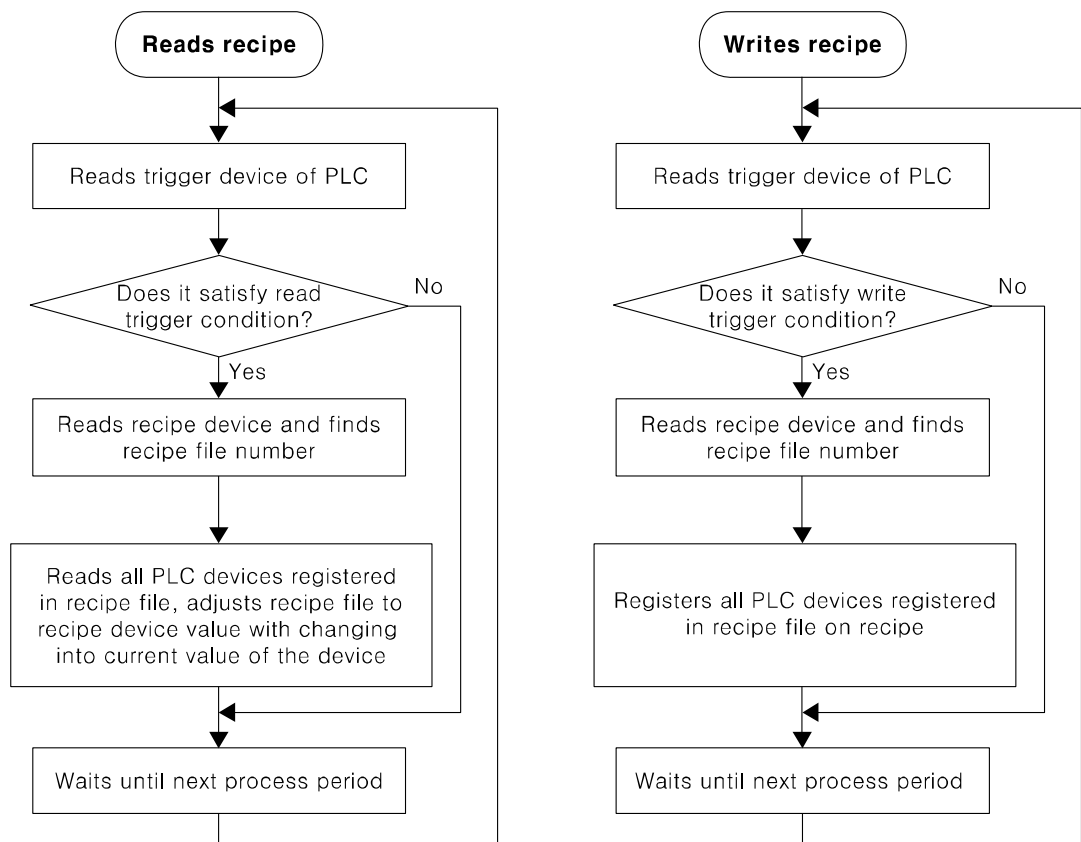

Note

- Maximum capacity of memory for recipe function is about $256 \times 4000 \times (16\text{bit}) = 2,000\text{kbyte}$. However, be aware that actual memory capacity of GP/LP does not meet this when you set this.
- Flash memory is able to be damaged physically when executing write operation more than regular frequency. It is require not to occurring read trigger frequently by proper PLC program or other device setting.

8.11.2 Property

8.11.2.1 Recipe dialog box

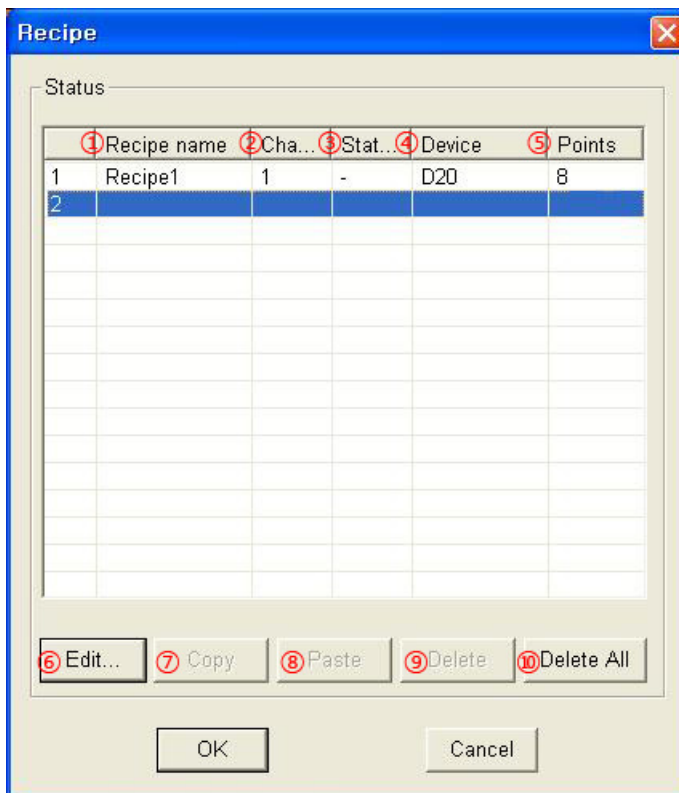

Recipe	Description
① Recipe name	Displays designated recipe name.
② Channel	Displays PLC channel for recipe.
③ Station	Displays PLC station for recipe. (PLC which does not support station is displayed '-'.)
④ Device	Displays lead device for set recipe.
⑤ Points	Displays recipe device point of each recipe.
⑥ Edit	Calls 'Recipe Property' dialog box and edit the selected item or create new recipe.
⑦ Copy	Copies the selected item.
⑧ Paste	Pastes copied item on the list box.
⑨ Delete	Deletes selected item.
⑩ Delete All	Deletes all recipes on the list box.

8.11.2.2 Recipe property dialog box

(1) Operation contents tab

Operation Contents	Description
① Recipe Name	Input recipe name which is up to 32 character of ASCII character.
② Device	Calls 'Device Select' dialog box and designate lead word device for recipe.
③ Number Of Device	Input device directly or displays the designated word device.
④ Number Of Device	Designate the number of device. From the designated lead device, recipe function is operated by series of the devices. Up to 4,000 can be designated.
⑤ Data Type	Select data type 16bit With Sign or 16bit Without Sign by pull down menu.



Note

For word device, depending on connected device type, it may use only 32bit. Refer to 'GP,LP user manual for communication'.

(2) Read trigger tab

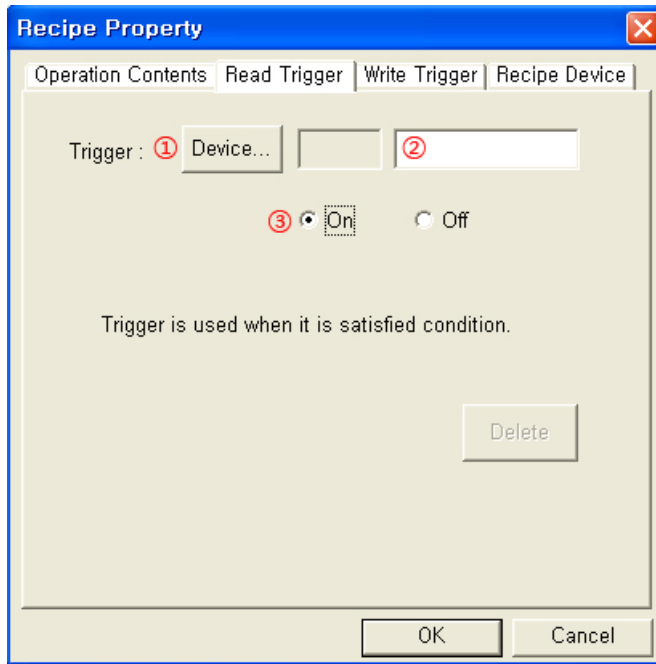

Read Trigger	Description
①② Device	Designate bit device for read trigger.
③ Trigger	<ul style="list-style-type: none"> On: Executes read operation when designated device turns ON. Off: Executes read operation when designated device turns OFF.

(3) Write trigger tab

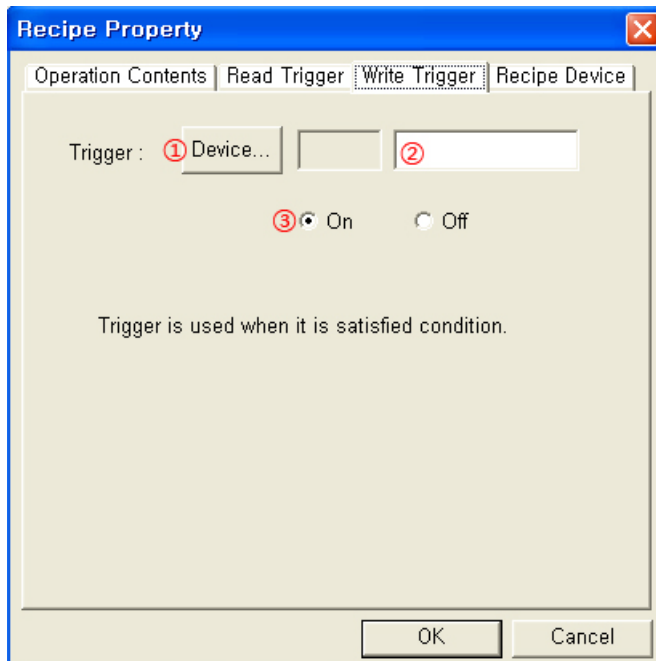

Write Trigger	Description
①② Device	Designate bit device for write trigger.
③ Trigger	<ul style="list-style-type: none"> On: Executes write operation when designated device turns ON. Off: Executes write operation when designated device turns OFF.

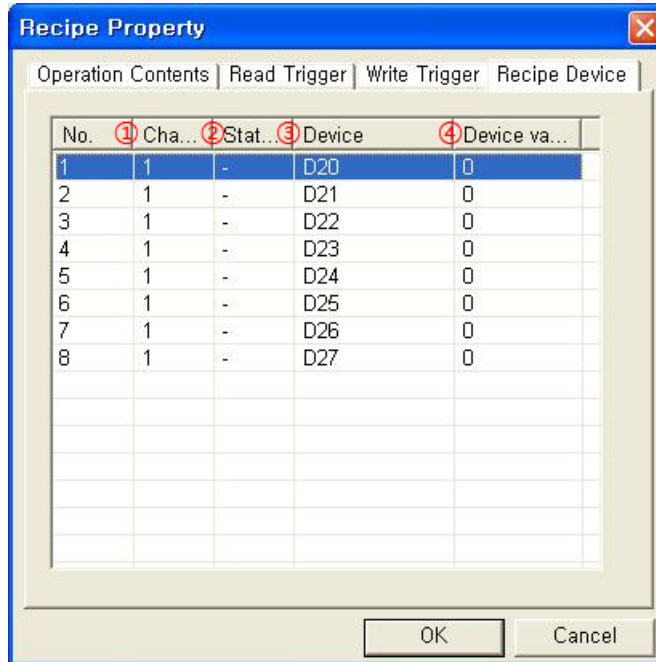
(4) Recipe device tab

Recipe Device	Description
①Channel	Displays PLC channel for recipe.
②Station	Displays PLC station for recipe. (PLC which does not support station is displayed '-')
③Device	Displays lead device for recipe.
④Device value	Displays set initial value of recipe area device and edit it.

8.12 Time Action

This function is for the specified bit device of inner PLC to turn ON/OFF when designated time and day. You can designate each time action of inner GP/LP by GP Editor, or by from GP/LP system menu, [Functionality]-[Time Switch]. You can designate bit device up to 8 with consecutive number.

Designated bit device turns ON when start time, and turns OFF when end time.

8.12.1 Basic operation

Select [Common]-[Time Action] of menu, 'Time Action' dialog box appears.

When downloading designated action data from 'Time Action' dialog box of GP Editor, designated items are displayed at GP/LP system menu [Functionality]-[Time Switch]. It is not able to upload items of GP/LP system menu [Functionality]-[Time Switch] to GP Editor.

8.12.2 Property

8.12.2.1 Time action dialog box

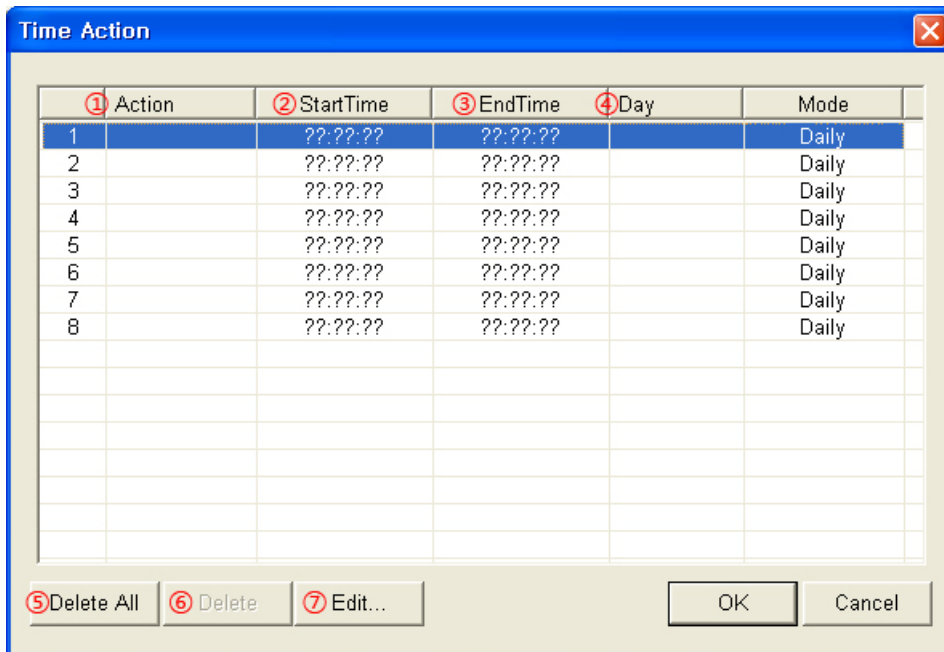

Time Action	Description
① Action	Displays designated bit device for time action.
② StartTime	Displays start time of each action.
③ EndTime	Displays end time of each action.
④ Day	Displays start day of week of each action.
⑤ Delete All	Deletes all designated items.
⑥ Delete	Deletes selected item on the list box.
⑦ Edit	Calls 'Time Action Attribute' dialog box and edit details about each time action. Bit device related with action is designated when editing the first item of list and other items have successive address after the device and they allotted automatically.

8.12.2.2 Time action attribute dialog box

Time Action Attribute	Description
① Start time	Designate start time (hour, minute, second) of action.
② Start day	Check start day of week of action.
③ End time	Designate end time (hour, minute, second) of action.

- 'Operation' tab is for designation bit device for action. It is able to designate lead device for the first item only.
- Designated bit device turns ON when start time of checked day and turns OFF when end time.

8.13 Barcode

It reads data from barcode reader and saves it to PLC.

8.13.1 Basic operation

For barcode reading, you should designate the followings in GP Editor at first.

- Designate device and data saving area for barcode reading from [Common]-[Barcode] of menu.
- Designate system signal 1 of system information from [Common]-[System Information] of menu.

Barcode reading action is controlled by three bits of designated device in system information.

- ① Limit signal for barcode input[PLC→GP/LP]
Bit4 of word device designated in read device of system information in GP Editor.
When this bit turns ON, it does not read barcode input.
- ② Completion signal for barcode read[PLC→GP/LP]
Bit5 of word device designated in read device of system information in GP Editor.
When this bit turns ON, barcode input signal is OFF and barcode input is prohibited until this signal is reset.
- ③ Barcode input signal[GP→PLC]
Bit8 of system signal 2 of system information in GP Editor is allocated.
This bit turns ON automatically when GP/LP saves all of barcode input values to save device of PLC.
When completion signal for barcode read is set, this bit is reset.



Note

Limit signal for barcode input and completion signal for barcode read should be controlled by PLC program.

Barcode information from barcode reader is saved at barcode device. After this, when reading barcode, it saves same device. You should move read barcode information to other area. Please create logic for controlling limit signal for barcode input and completion signal.

8.13.2 Barcode read order

- 1st Reset limit bit of barcode input and completion bit of barcode read to make readable state.
- 2nd Barcode input signal is set when reading barcode.
- 3rd Set limit bit of barcode input not to read input anymore.
- 4th Move saved data at barcode device to other area.
- 5th Set completion bit of barcode and barcode input signal is reset.
- 6th Repeat 1st to 4th execution.

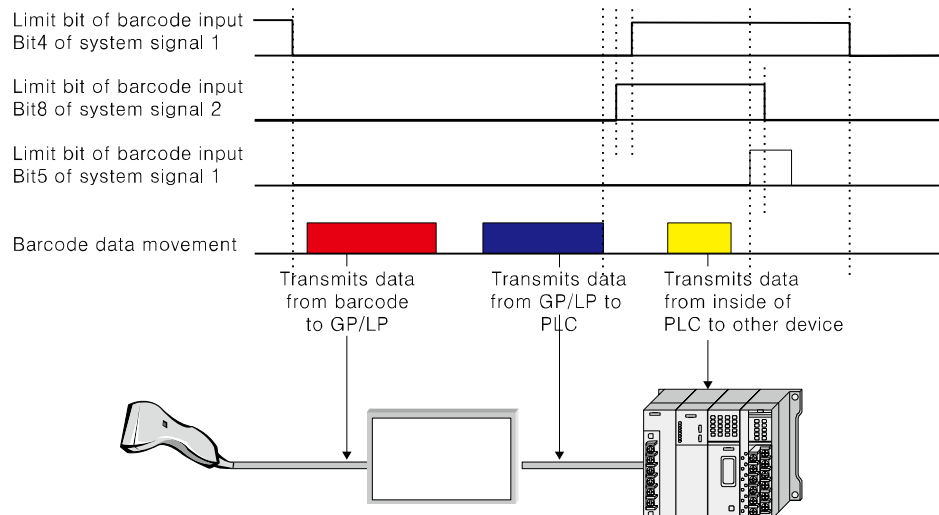
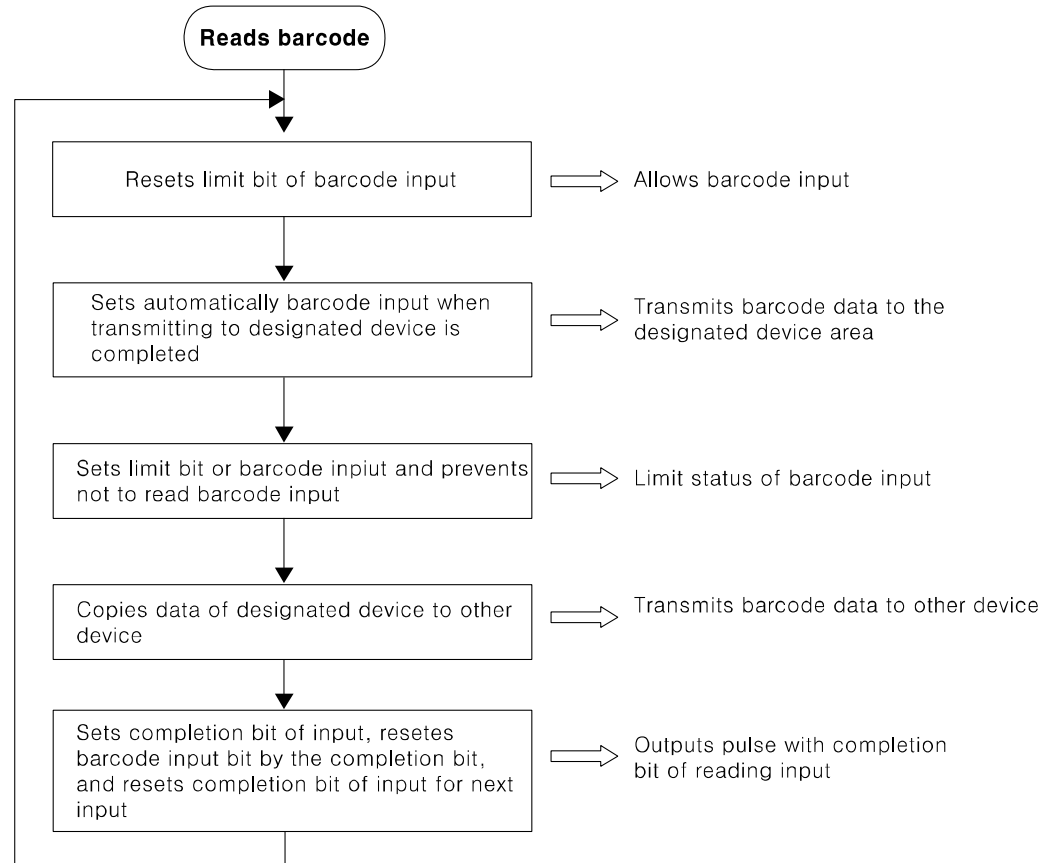

8.13.3 Save

Select [Common]-[Barcode] and 'Barcode' dialog box appears.

Designate device for saving data from barcode reader.

When designating lead device and device point, successive word register as points including lead device is used for saving barcode data.

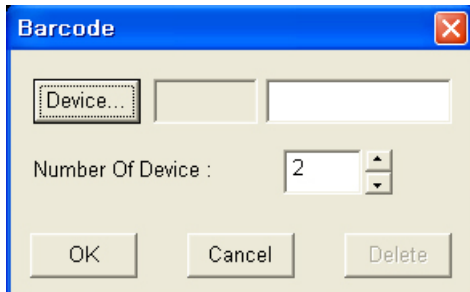

- Lead device saves the number of byte (the number of character) and after this devices save read (ASCII) code.
- If data is less than the number of designated device for saving, other area is filled with 20H[SPACE].
- If data is more than the number of designated device for saving, it saves data up to available area and the others are not saved. In this case, lead device saves actual reading.



Ex.

In case, Barcode='1234567', Device=D100, Number of device= 7;

Device	Saved data	ASCII Character	Description
D100	0007H		The number of read byte.
D101	3231H	'1"2'	Saves data in order of from lower byte to upper byte.
D102	3433H	'3"4'	
D103	3635H	'5"6'	
D104	2037H	'7' ' '	After last device address is filled with 20H (space).
D105	2020H		
D106	2020H		

In case, Barcode='1234567', Device=D100, Number of device=4;

Device	Saved data	ASCII Character	Description
D100	0007H		The number of read byte.
D101	3231H	'1"2'	Saves data in order of from lower byte to upper byte.
D102	3433H	'3"4'	
D103	3635H	'5"6'	The other data is not saved.

8.13.4 Specification of available barcode reader

In order to use barcode reader, you should set connection as 'Barcode' from GP/LP system setting [Environment]-[Serial Communication] and speed, data length, etc also as connected barcode reader's specification.

Interface	RS232/RS422
Speed	300, 600, 1200, 2400, 4800, 9600, 19200, 38400, 57600 bps
Data length	7, 8 Bit
Stop bit	1, 2 Bit
Parity	ODD, EVEN, NONE
Flow control	XON/XOFF, DSR/DTR, NONE
Communication format	ASCII character code and exit code CR[0DH] [ASCII data + Exit code]

Interface, and speed are designated same with other serial devices connected with GP/LP.

8.14 Auxiliary Configuration

8.14.1 Project

Refer to '2.1.2 Project auxiliary property'.

8.14.2 Screen

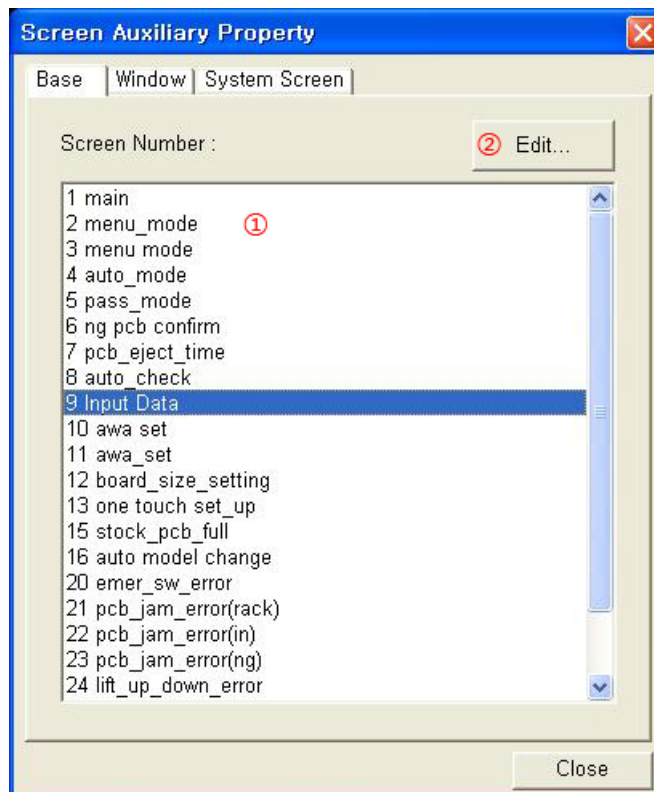

Base	Description
①Screen Number	Displays all base screen of the project as a list.
②Edit	Edit the selected base screen at ①.

You can designate for cursor movement for key action, allowing floating alarm, background color, and security level of each base screen's configuration.

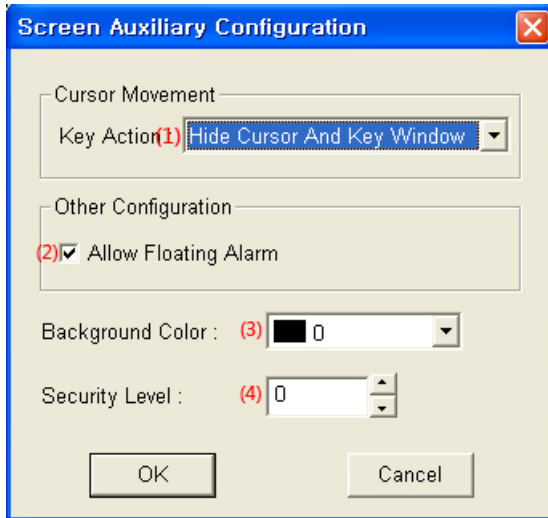

(1) Cursor Movement

Designate cursor movement when touching ENT, CLR, UP, or DOWN key window at numeral input, ASCII input mode by pull-down menu.

- No Movement
When touching CLR, ENT key window, key window is not closed and cursor does not move to other input tag. Even though touching UP or DOWN key window, cursor does not move to other input tag.
- Order Of User ID
When touching ENT, cursor moves in order to designated user ID.

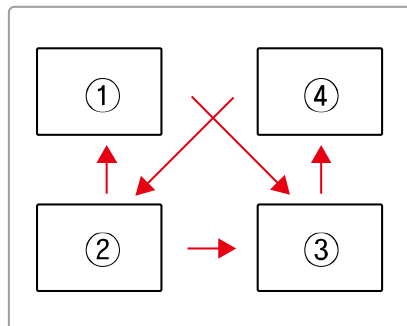

Input tag	User ID	Destination ID
①	3	1
②	4	1
③	1	2
④	2	4

- Touching at ①: Repeats ①→③→④→②→③→④→②③④
- Touching at ②: Repeats ②→③→④→②③④
- Touching at ③: Repeats ③→④→②→③→④→②③④
- Touching at ④: Repeats ④→②→③→④→②③④
- Hide Cursor And Key Window
When touching CLR/ENT, it hides cursor and key window. If there are designated user ID and destination ID, cursor moves in accordance with designated value when touching UP/DONW key window.

(2) Other Configuration

Designate allowing floating alarm function or not. Checking this, the designated comment floats when designated alarm at 'Alarm Floating' dialog box occurs.

(3) Background Color

Designate background color of current editing screen.

- Mono type(GP-S044, GP-S057, LP-S044): White/Black
- Color type(GP-S070, LP-S070): 24bit True Color

(4) Security Level

Designate security level of current editing screen.

Security level 0 is not designated security state, security level 1 is the lowest and security level 15 is top level. For further detail, refer to '8.6 Security'.

9 Appendix

9.1 USB driver installation

'GP/LP USB Driver' is driver for communication PC and GP/LP by USB cable.

Before installing 'GP/LP USB Driver', visit our homepage(www.autonics.com) and download setup file.

Downloaded zip file name is as following.

GP_LP_Series.inf, GP_LP_Series.sys

(1) Install with found new hardware wizard

1st Connect GP/LP to PC with USB cable and 'Found New Hardware Wizard' operates.

2nd Select 'No, not this time' and click 'Next'.



3rd Select 'Install from a list or specific location (Advanced)' and click 'Next'.

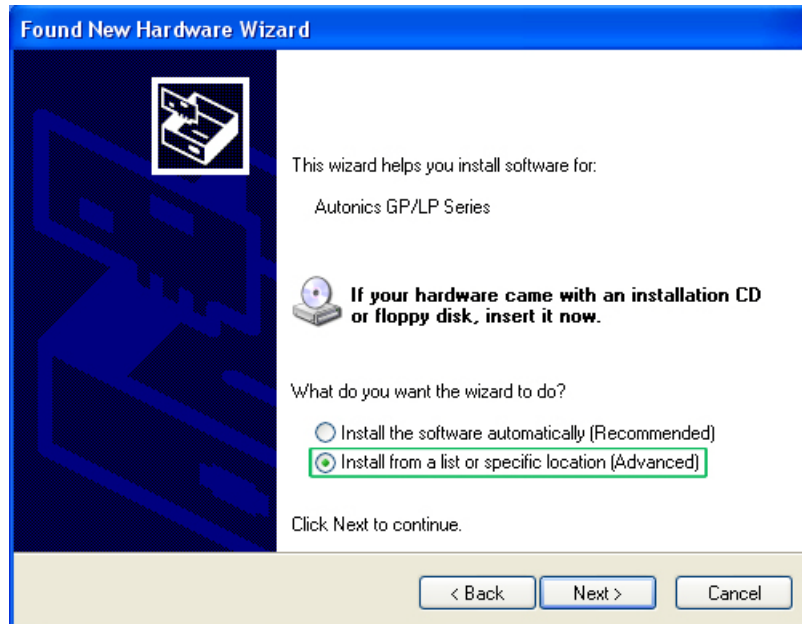

4th Select 'Don't search. I will choose the driver to install.' and click 'Next'.

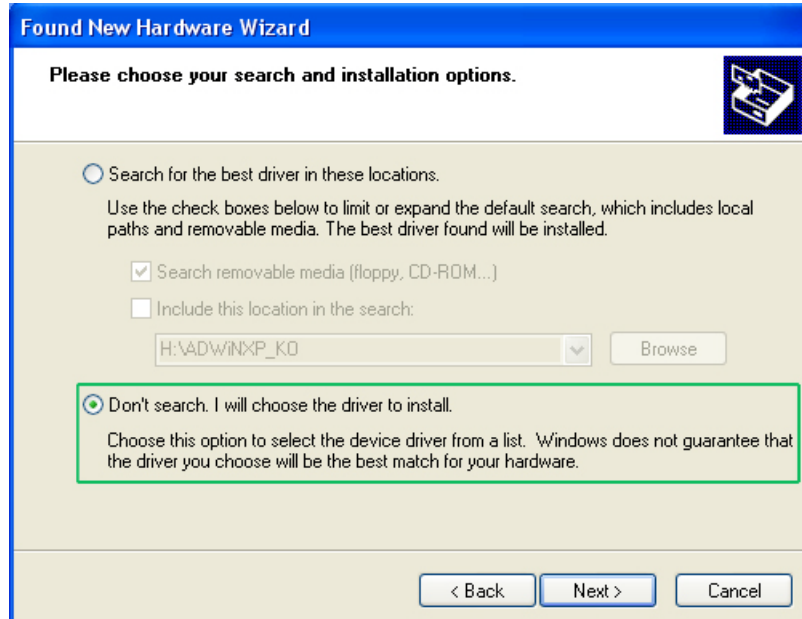

5th Select 'Show All Devices' for common hardware type and click 'Next'.

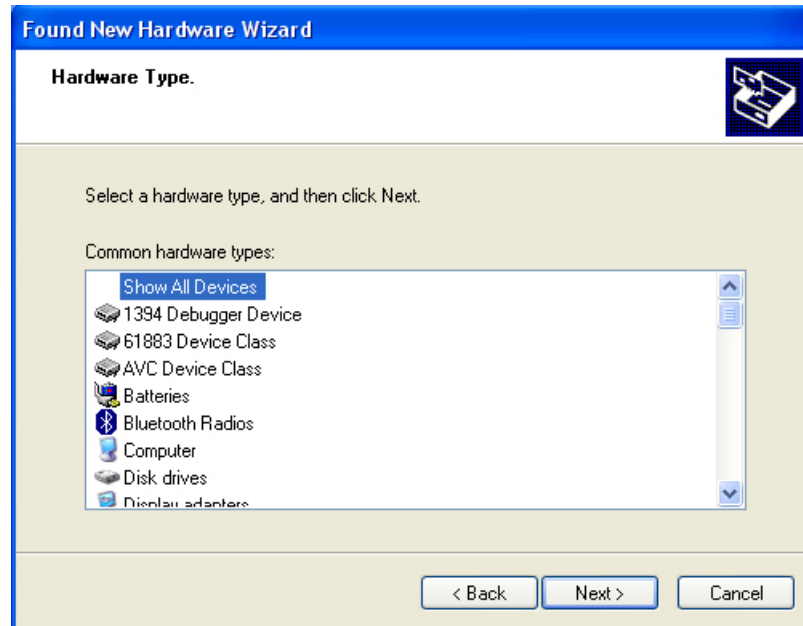

6th Select '(Standard system devices)' and 'HID-compliant game controller' and click 'Have Disk' and 'Install From Disk' dialog box appears.

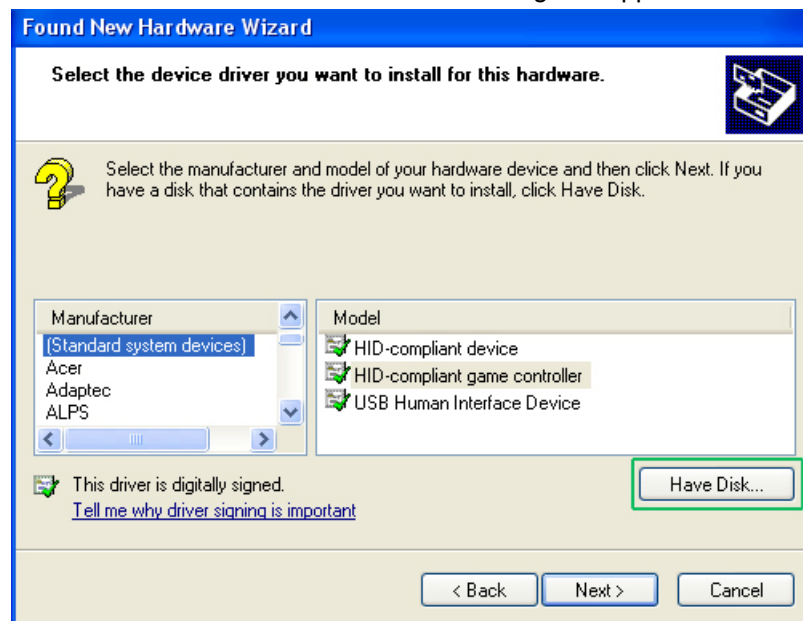

7th Click 'Browse', designate GP/LP USB Driver folder and click 'OK'.

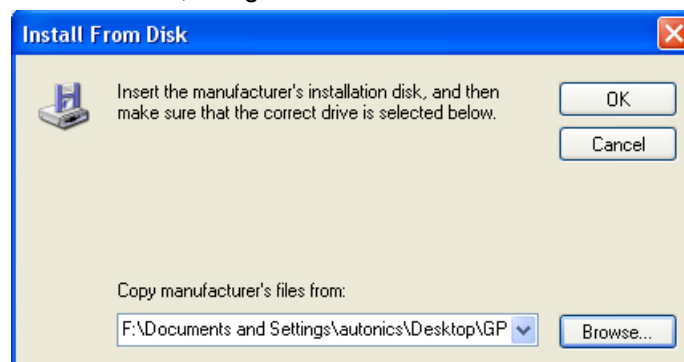

8th Select 'GP/LP Series' as below feature and click 'Next'.

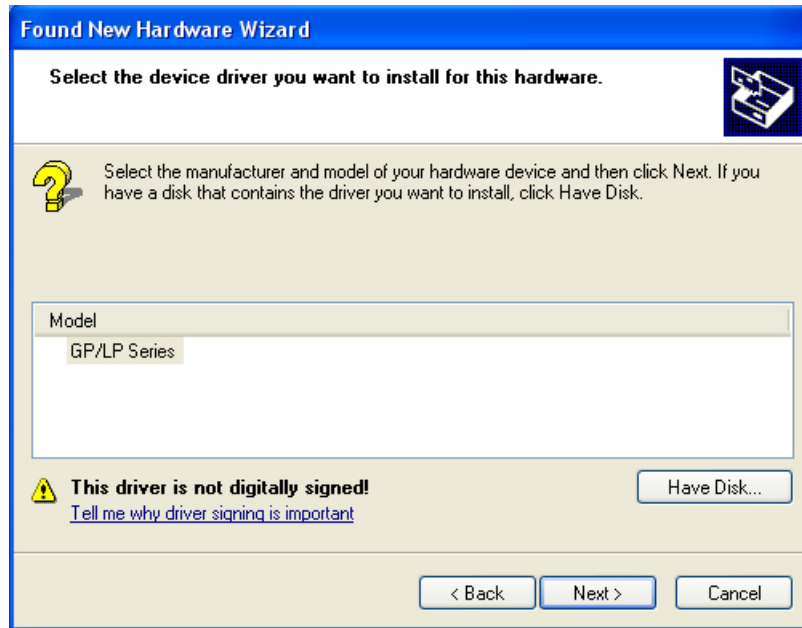

During installing driver, if following message appears, click 'Yes' and continues installing driver.

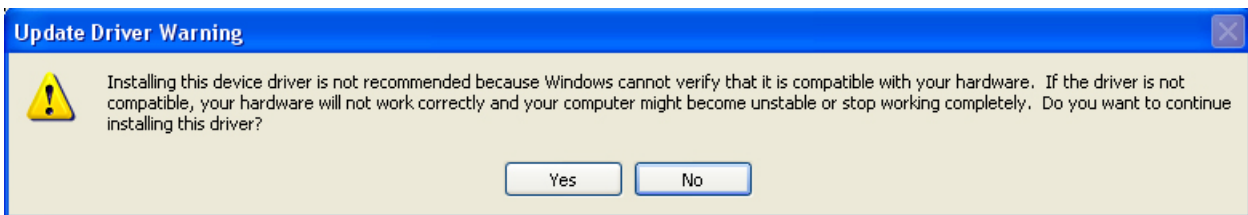

9th Processes installing GP/LP USB Driver.

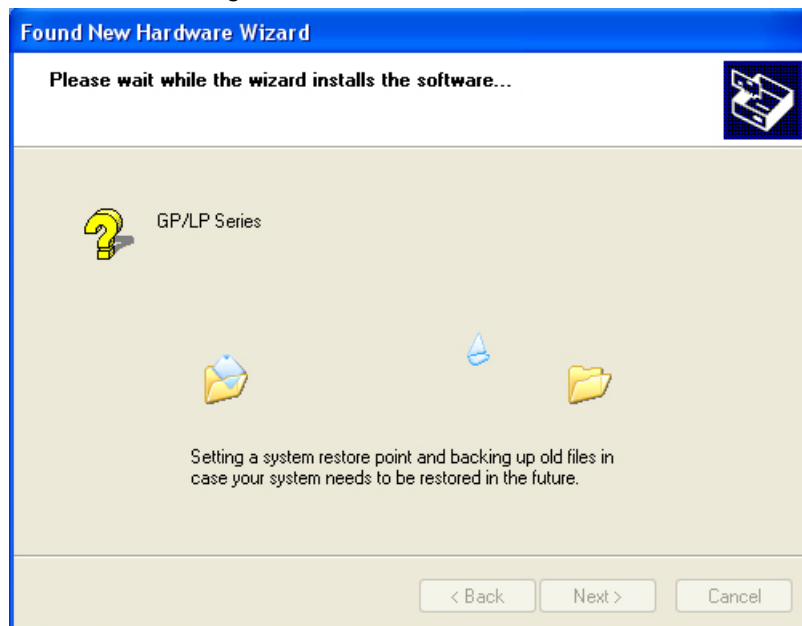

10th Click 'Finish' and completes installing driver.



You can check installed driver at [Start]-[Control Panel]-[System]-[Hardware]-[Device Manager].

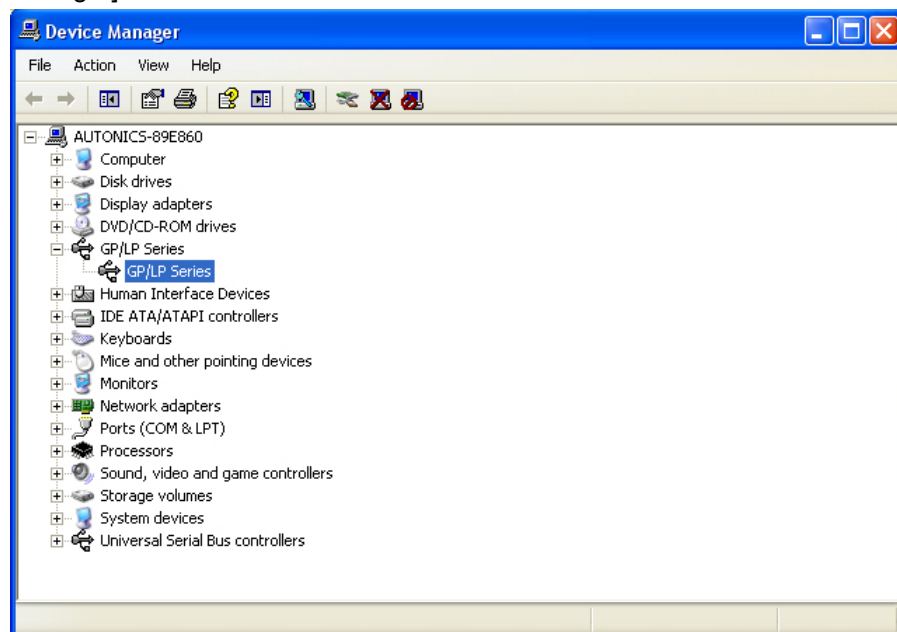

(2) Install with device manager

1st If 'Found New Hardware Wizard' does not operate, you can install USB driver at [Start]-[Control Panel]-[System]-[Hardware]-[Device Manager].

Uninstalled driver displays '?' as following feature.

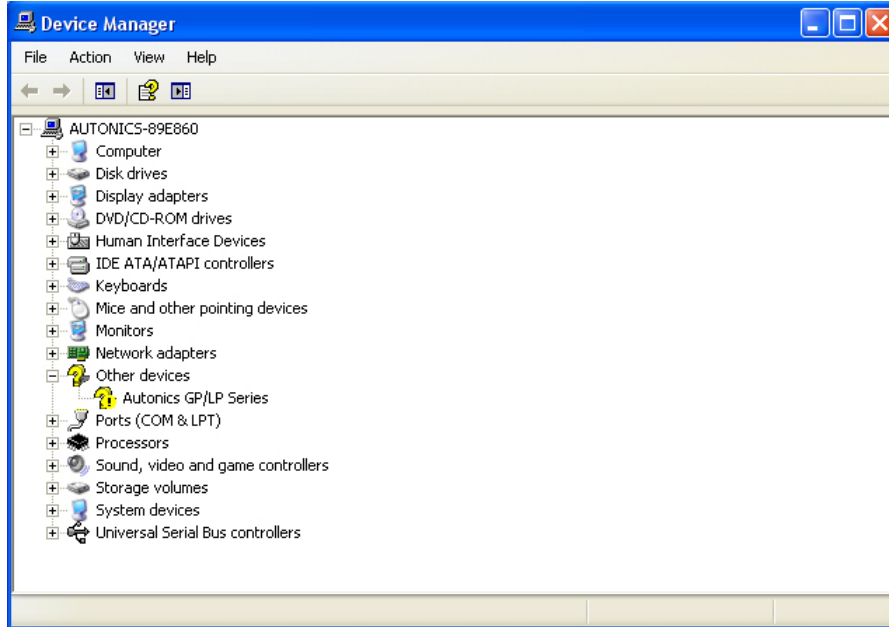

2nd Click 'Autonics GP/LP Series' with right mouse button and pop-up menu appears.

Select 'Properties'.

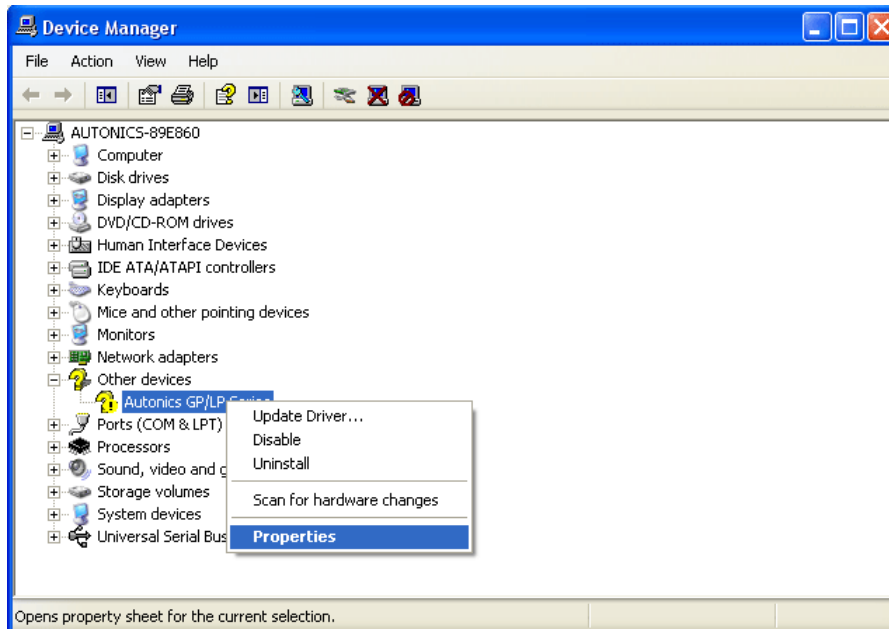

3rd 'Autonics GP/LP Series Properties' dialog box appears. Click 'Reinstall Driver'.

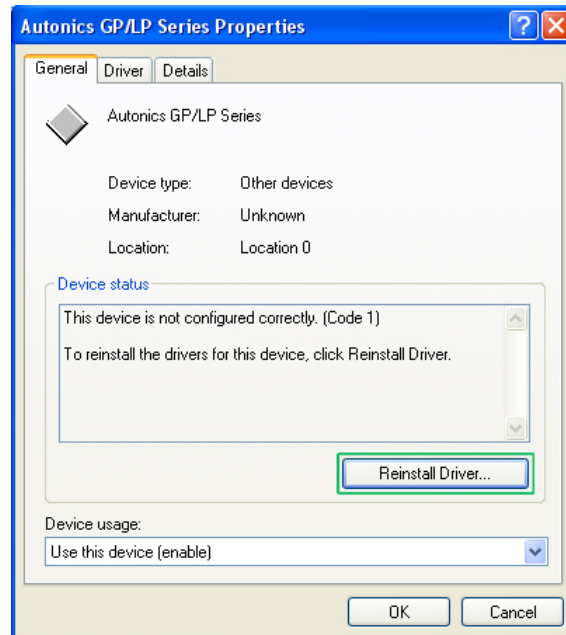

4th 'Found New Hardware Wizard' operates. Next steps are same as '(1)Install with found new hardware wizard' and please refer this.

5th After installing GP/LP USB driver, you can check installed AUTONICS USB Flash Disk USB Device as mass storage device and GP/LP Series USB driver at [Device Manager].

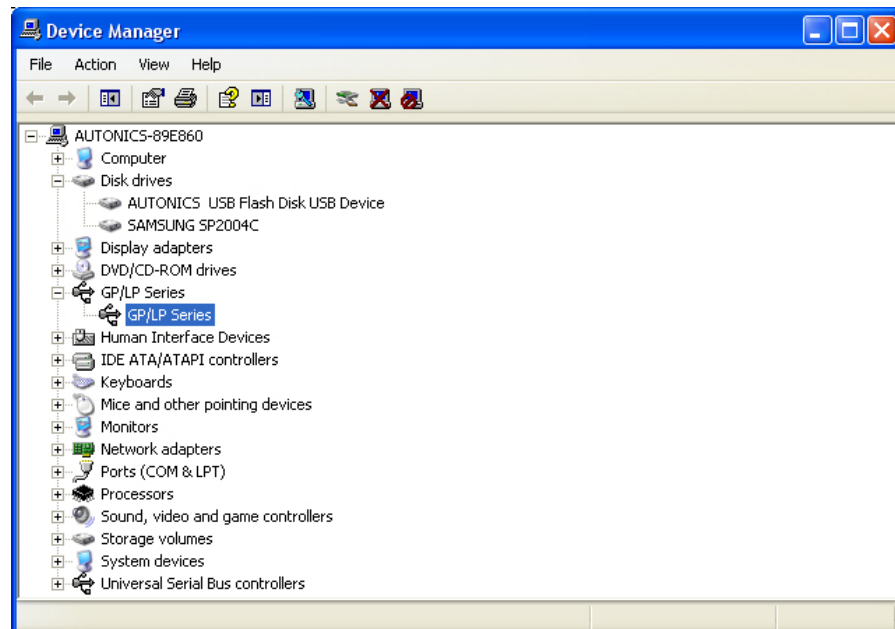

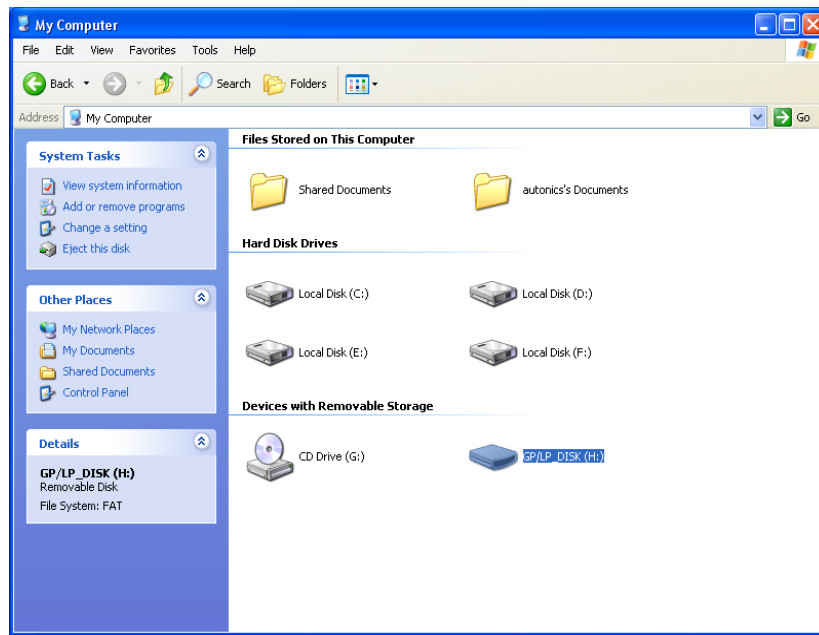

9.2 GP Editor runs in Windows 7 operating system

To run GP Editor in windows 7 operating system, you need to configurate it as following.
(If an account of Window7 is 'Adminstrator', GP Editor runs normally without configuration.)

9.2.1 GP Editor runs as administrator

1st Select 'GP Editor' icon and click it with right mouse button and pop-up menu appears.
Select 'Properties (R)'.

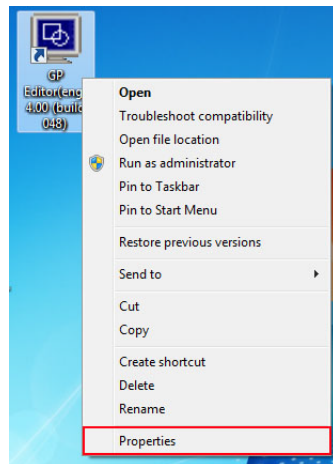

2nd 'GP Editor Properties' dialog box appears. Select 'Compatibility' tab.
(Check one 'Compatibility mode' or 'Privilege Level'.)

Checking compatibility mode: Check 'Run this program in compatibility mode for:' and select 'Windows XP (Service Pack 3)' by below pull down menu and click 'OK'.

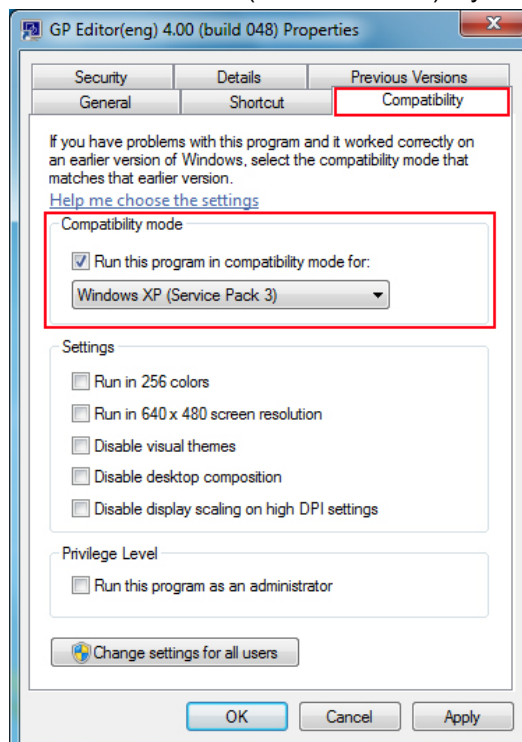

Checking privilege level: Check 'Run this program as an administrator' and click 'OK'.

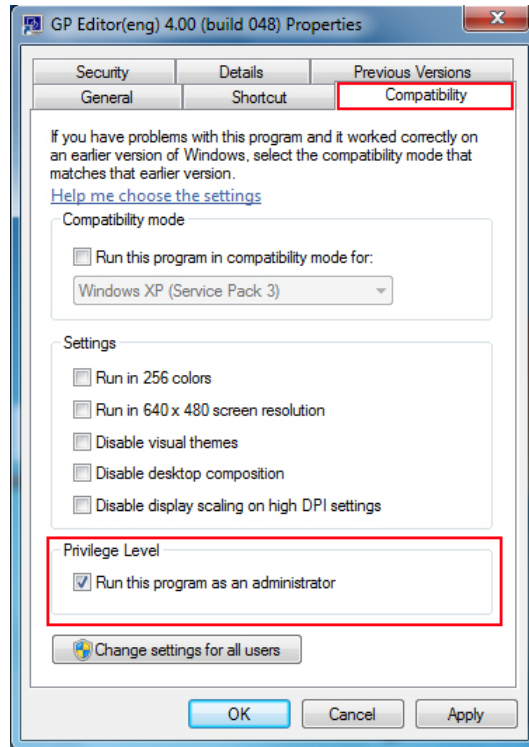

3rd Executes GP Editor, 'User Account Control' dialog box appears. Click 'Yes(Y)' and GP Editor executes.

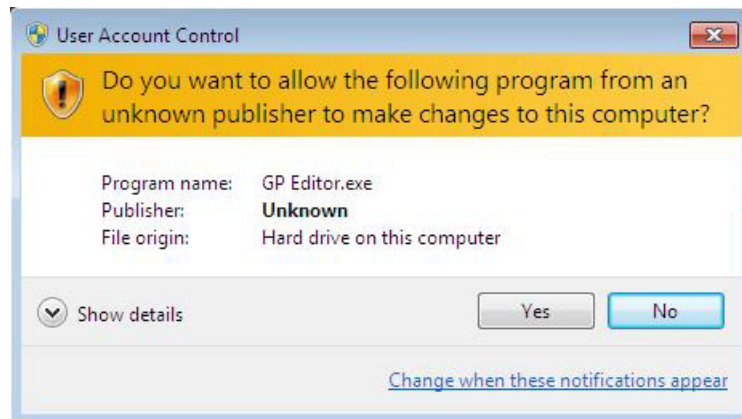

To disable 'User Account Control' dialog box, refer to '9.2.3 Disable to user account control dialog box'.

9.2.2 In case of no administrator account (Create administrator account windows 7)

1st Select [Start]-[Control Panel]-[Add or remove user accounts].

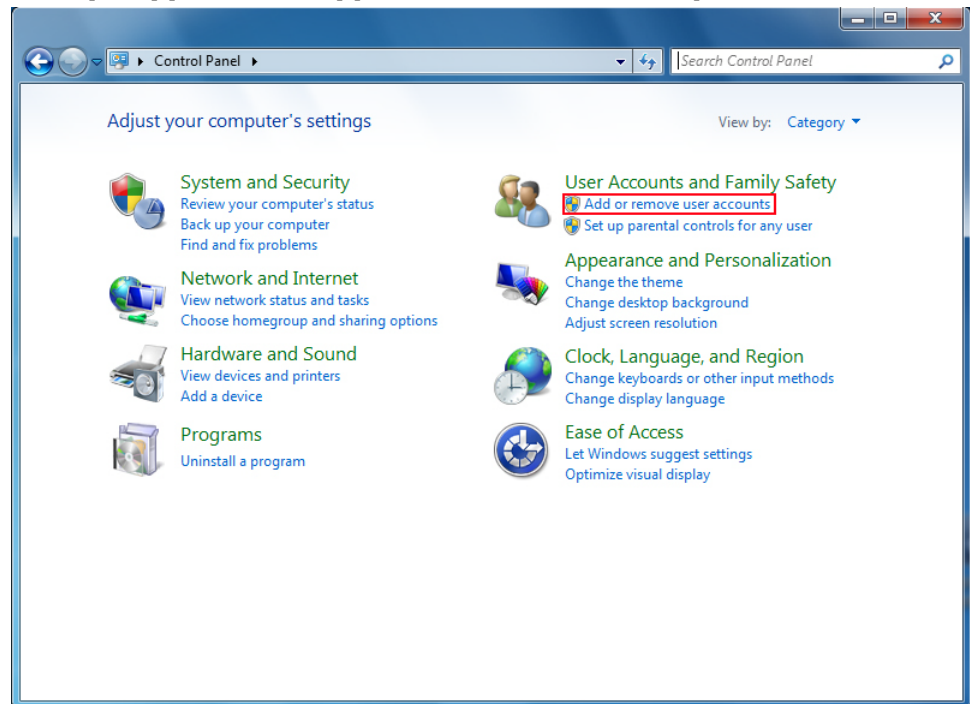

2nd Click 'Create a new account'.

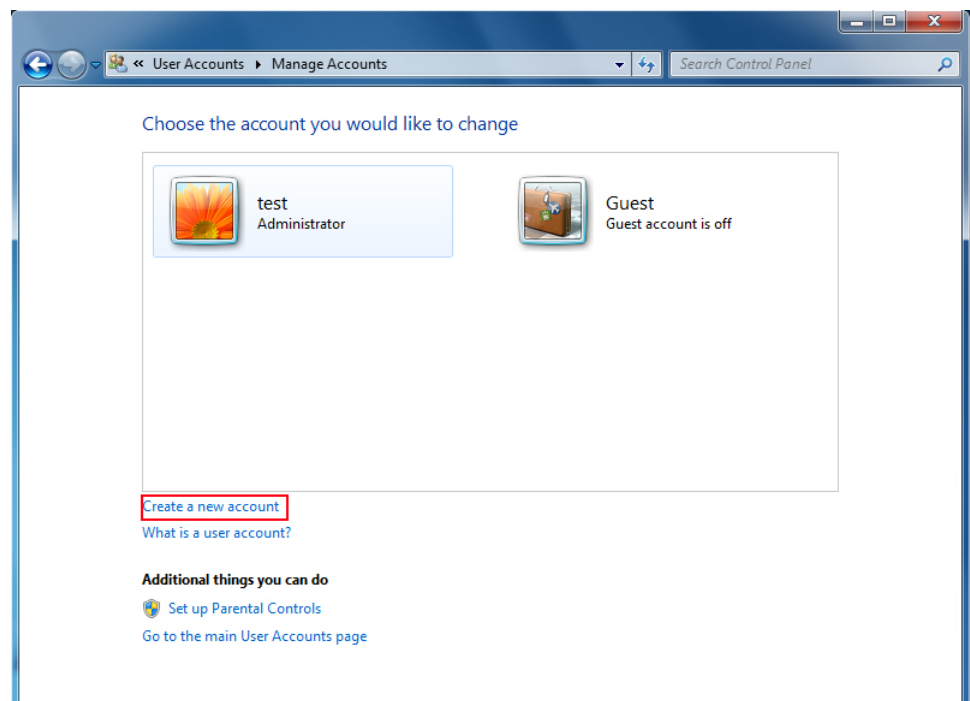

3rd Enter the desired account name in 'Name the account and choose an account type' and select 'Administrator (A)' and click 'Create Account'.

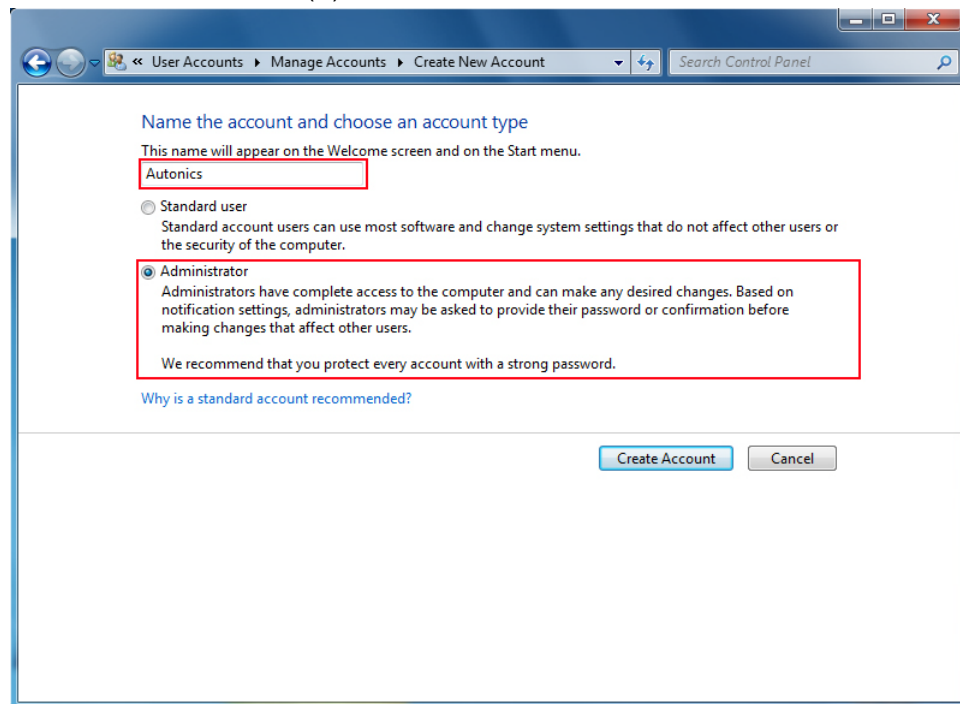

4th It completes creating administrator account.

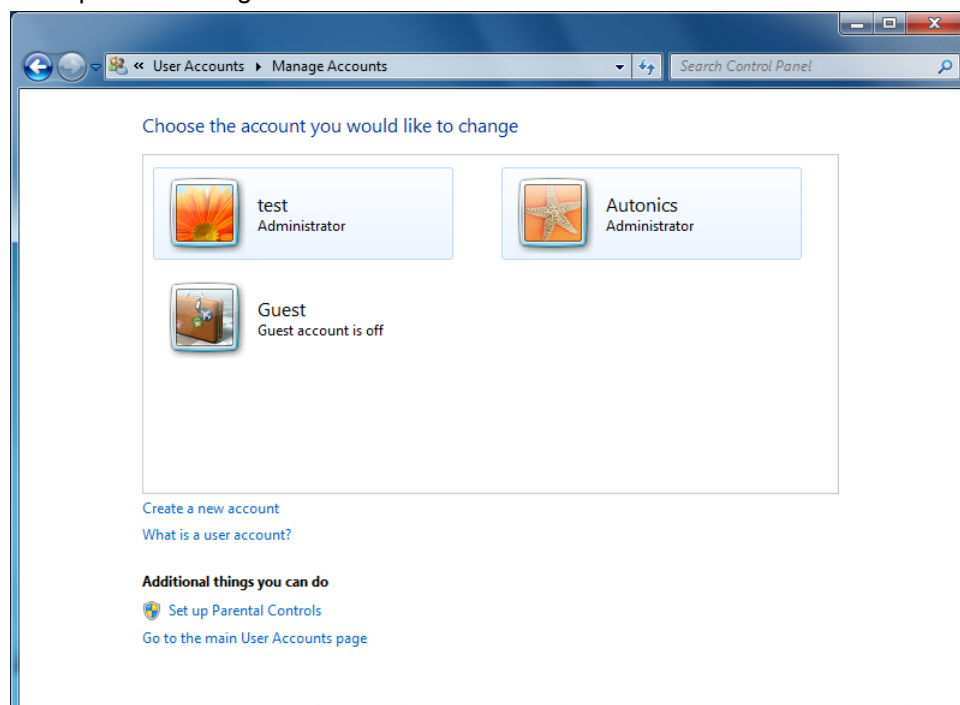

9.2.3 Disable to user account control dialog box

1st Select [Start]-[Control Panel]-[System and Security].

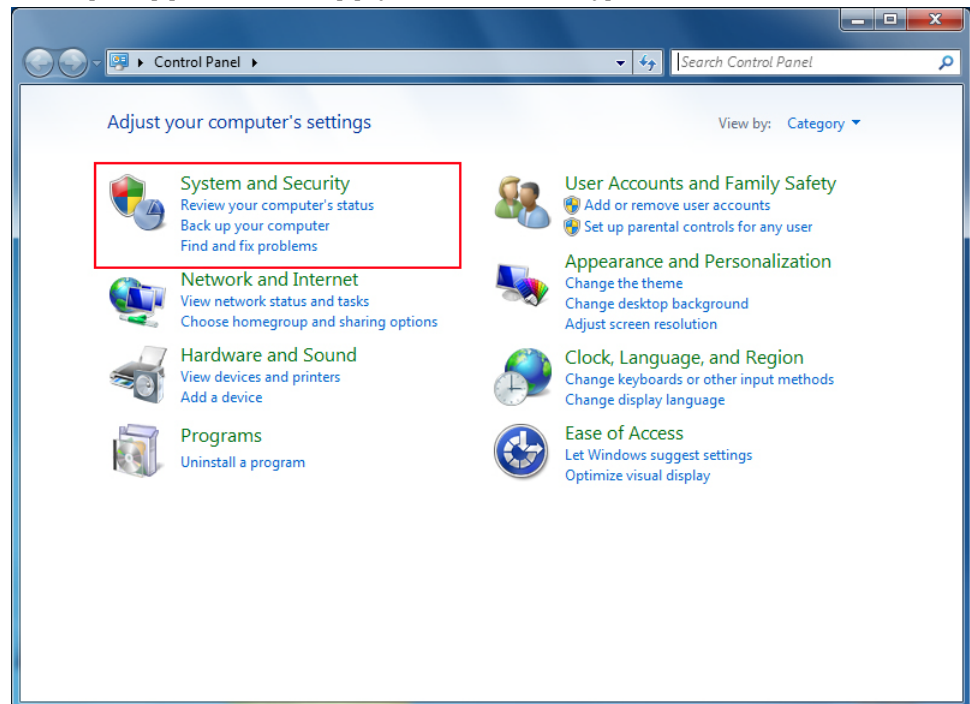

2nd Click 'Change User Account Control settings'.

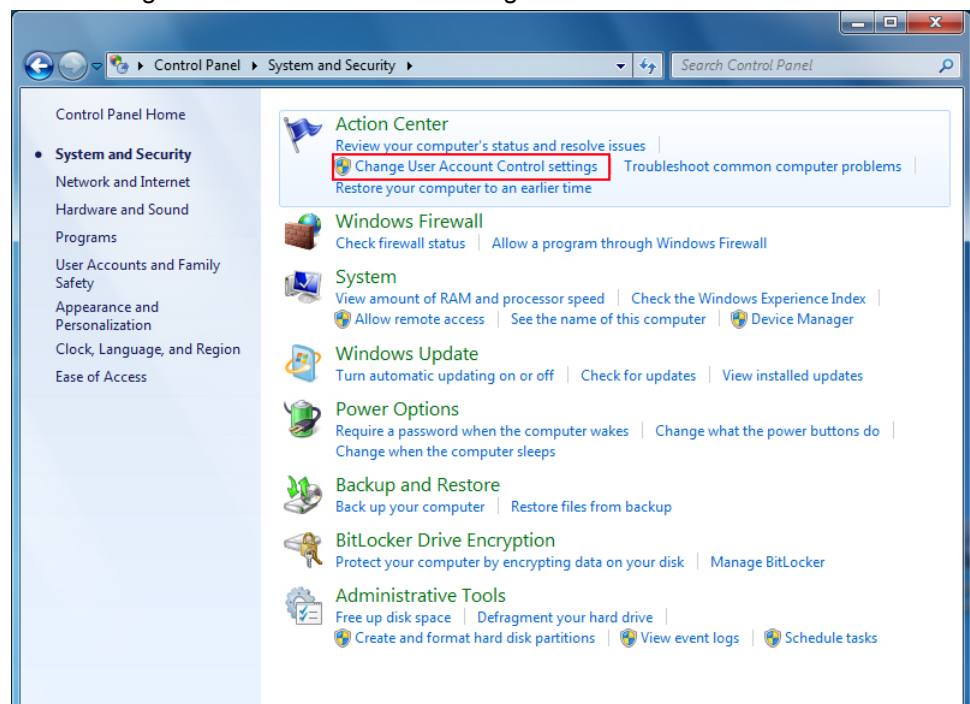

3rd 'User Account Control Settings' dialog box appears. Select as 'Never notify' and click 'OK'.

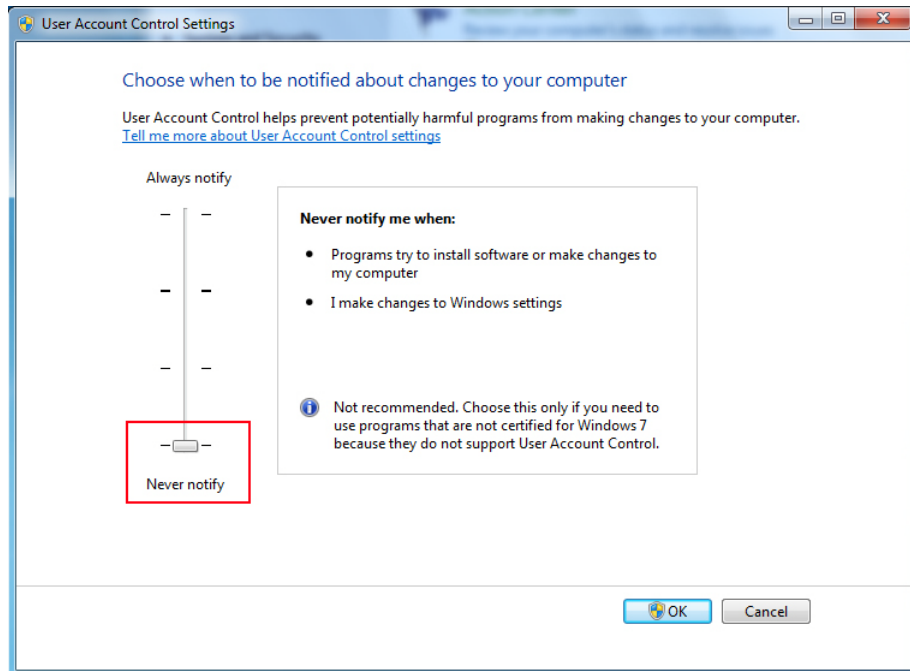

Autonics

Sensors & Controllers

www.autonics.com

Distributor



Major products

Proximity sensors • Photoelectric sensors • Area sensors • Fiber optic sensors • Door/Door Side sensors • Pressure sensors • Rotary encoders • Sensor controllers • Switching power supply • Temp. controllers • Temperature/Humidity transducers • Power controllers • Recorders • Tachometer/Pulse(Rate) meters • Panel meters • Indicators • Signal converters • Counters • Timers • Display units • Graphic panel • Stepping Motors & Drivers & Motion controllers

Any proposal for a product improvement and development: Product@autonics.com

Headquarters

41-5, Yongdang-dong, Yangsan-si, Gyeongnam, 626-847, Korea

Overseas Business Dept.

Bldg. 402 3rd Fl., Bucheon Techno Park, 193, Yakdae-dong, Wonmi-gu, Bucheon-si, Gyeonggi-do, 420-734, Korea

Tel: 82-32-610-2730 / Fax: 82-32-329-0728 / E-mail: sales@autonics.com

Brazil

Autonics do Brasil Comercial Importadora Exportadora Ltda

Tel: 55-11-3055-1660 / Fax: 55-11-3055-1661 / E-mail: vendas@autonics.com.br

China

Autonics electronic(Jiaying) Corporation

Tel: 86-573-8216-1900 / Fax: 86-573-8216-1917 / E-mail: china@autonics.com

India

Autonics Corporation - India Liaison Office

Tel: 91-22-2781-4305 / Fax: 91-22-2781-0538 / E-mail: india@autonics.com

Indonesia

PT. Autonics Indonesia

Tel: 62-21-6586-6740 / Fax: 62-21-6586-6741 / E-mail: autonics@cbn.net.id

Japan

Autonics Japan Corporation

Tel: 81-3-5730-0568 / Fax: 81-3-5730-0569 / E-mail: ja@autonicsjp.co.jp

Malaysia

Mal-Autonics Sensor Sdn. Bhd.

Tel: 60-3-7805-7190(Hunting) / Fax: 60-3-7805-7193 / E-mail: malaysia@autonics.com

Mexico

Autonics Mexico Sales Office

Tel: 52-55-5207-0019 / Fax: 52-55-5207-0099 / E-mail: ventas@autonics.com

Russia

Autonics Corp. Russia Representative Office

Tel/Fax: 7-495-745-2343 E-mail: russia@autonics.com

Turkey

Autonics Otomasyon Ticaret Ltd. Sti.

Tel: 90-212-222-0117 (PBX) / Fax: 90-212-222-0108 / E-mail: info@autonics.com.tr

USA

Autonics USA, Inc.

Tel: 1-847-680-8160 / Fax: 1-847-680-8155 / E-mail: sales@autonicsusa.net

Vietnam

Autonics Vietnam Representative Office

Tel: 84-8-3925-6563 / Fax: 84-8-3925-6564 / E-mail: vietnam@autonics.com