



# Product Guide

Sensors and Measuring Systems

Displacement  
Distance  
Position

Dimension  
Temperature  
Color

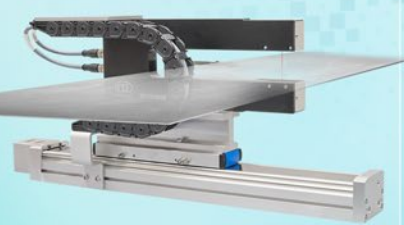
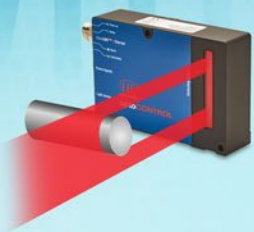

More Precision



## Why choose Micro-Epsilon?

- More precision and innovation made in Germany
- Wide range of powerful and flexible products which are easy to integrate
- Consultation, development and production from a single source
- Hand in hand with our customers we create quality and solution competence in series & OEM
- Profound knowledge of industries & applications in automation, machine building and machine design

As a technology leader of precision sensors, Micro-Epsilon pursues the need to develop high precision sensors, measurement devices and systems. This need is the drive for continuous high performance in measurement technology. As well as sensors for displacement, distance, position, color and temperature, we also focus on 3D sensors.

Continuous development efforts, extensive know-how and a wide cooperation network enable us to develop high precision sensors. Further development of measuring techniques and technical innovations is our basis for the creation of sensor products that provide our customers with significant added value.

# Contents

<b>Sensors for displacement, distance, length and position</b>	<b>Page</b>
Laser triangulation sensors	6 - 7
Confocal sensors for measuring displacement and thickness	8 - 9
White light interferometer for displacement and thickness measurements	10 - 11
Laser gauges and distance sensors	12 - 13
Capacitive displacement sensors	14 - 15
Eddy current displacement sensors	16 - 17
Inductive displacement sensors	18 - 19
Magneto-inductive distance sensors	20 - 21
Draw-wire displacement sensors	22 - 23
<b>2D/3D sensor systems for dimensional measurement</b>	<b>Page</b>
Laser profile sensors	24 - 25
Optical micrometers & fiber optic sensors	26 - 27
3D Measurement & surface inspection	28 - 29
<b>Color sensors for surfaces and self-luminous objects</b>	<b>Page</b>
Color sensors, color measuring system & LED Analyzers	30 - 31
<b>Infrared temperature measurement</b>	<b>Page</b>
IR temperature sensors	32 - 33
Thermal imaging cameras	34 - 35
<b>Application-specific solutions</b>	<b>Page</b>
Special sensors & OEM sensors	36 - 37
Measuring & inspection systems	38 - 39

# > More Precision

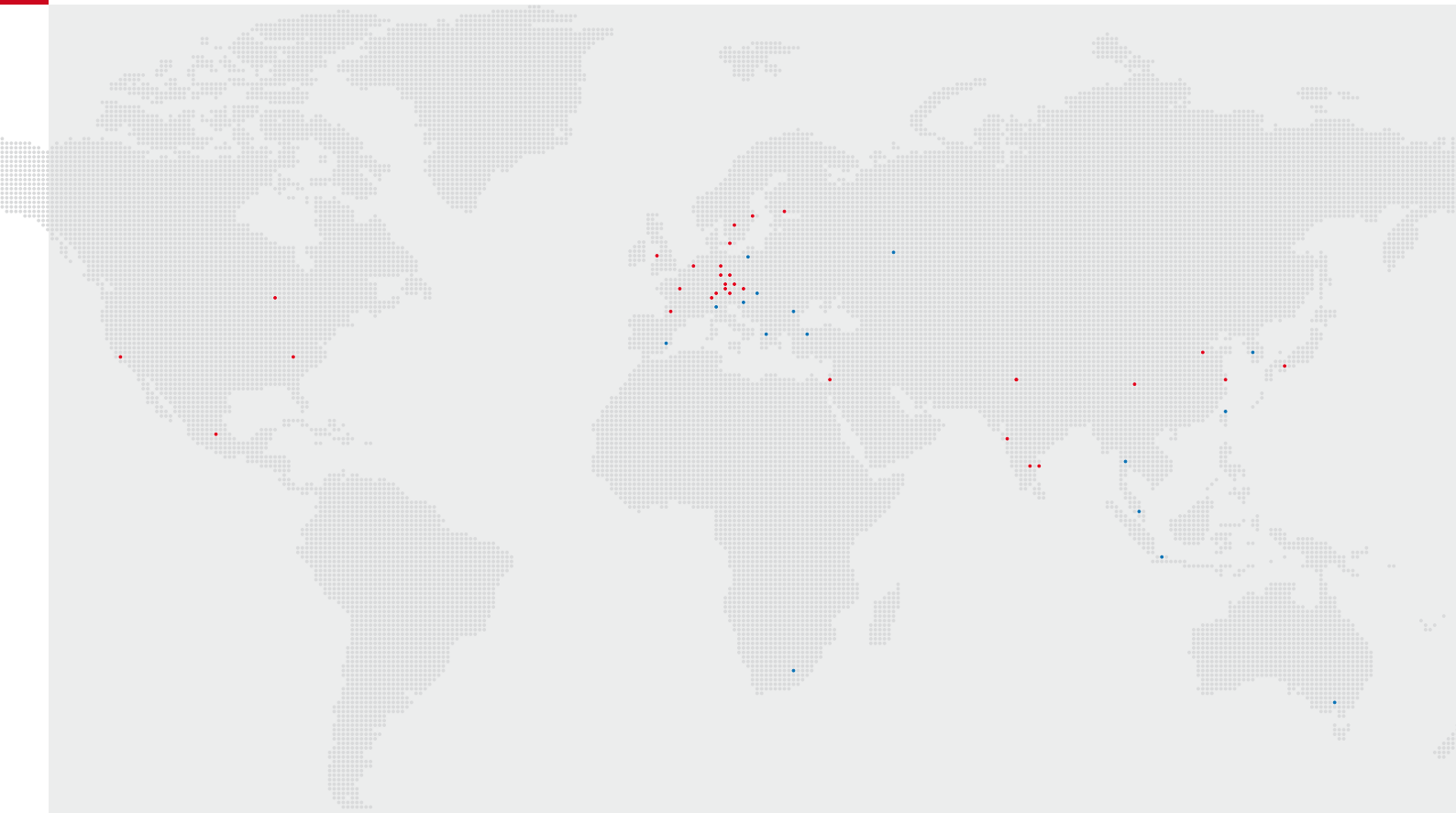

Sensors and measurement devices from Micro-Epsilon are used in numerous industries. Whether it is for quality assurance, applications in maintenance, process and machine monitoring, automation or R&D - sensors make a vital contribution to the improvement of products and processes. From global major groups to medium-sized companies and engineering service providers - sensors and solutions from Micro-Epsilon ensure reliable measurement results with the highest precision all over the world. From machine building and automated production lines in the food industry, to integrated OEM solutions - almost all industries benefit from sensor technologies.

Micro-Epsilon has the experience and the required resources to provide solutions starting from the basic idea through to series production, all from one source – and at a convincing price/performance ratio. A team of specialist development and application engineers implements concepts and designs according to customer-specific requirements. All project members are involved in development, prototype construction and series production.

Semiconductors & lenses

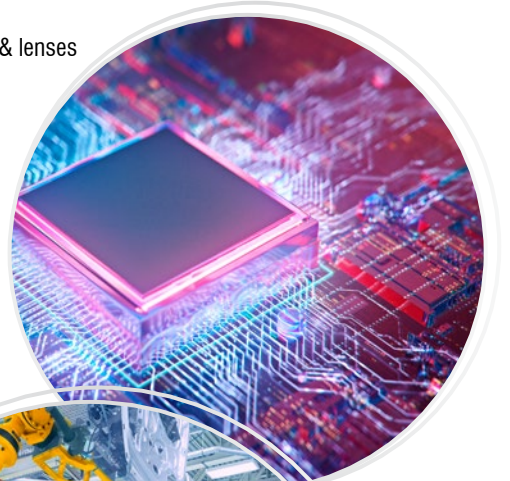

Advanced automation



Aerospace



Additive manufacturing



Automotive



Renewable energies

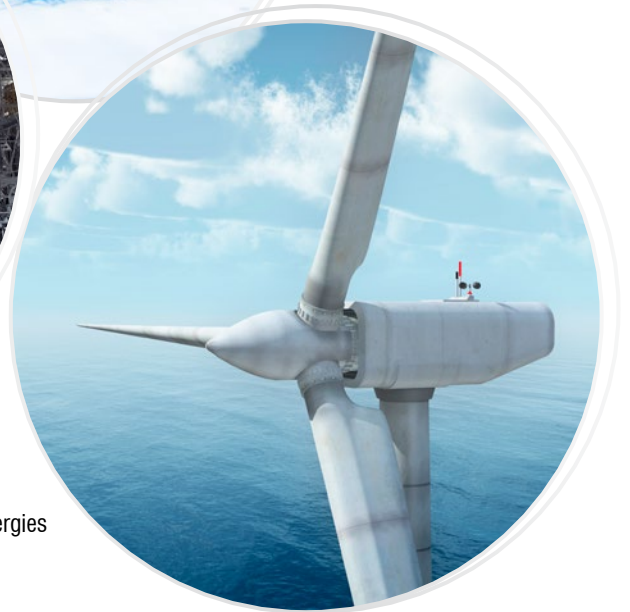

# Laser triangulation sensors

for precise displacement distance measurements

## optoNCDT

- Measurement of displacement, distance and position on numerous surfaces
- Detection of smallest parts due to point-shaped measurement
- Comprehensive product range with numerous measuring ranges
- High resolution and linearity
- Ideal for measurement tasks with high measuring rates
- Numerous interfaces, also for bus connection



optoNCDT sensors are designed for both measurement tasks in factory automation and integration into machines and systems. Despite their very compact dimensions, these robust laser sensors have a fully integrated controller. As a result, simple installation and wiring is possible in confined installation spaces or on a robot. Their high performance enables the sensors to provide precise measurement results at a high measuring rate.

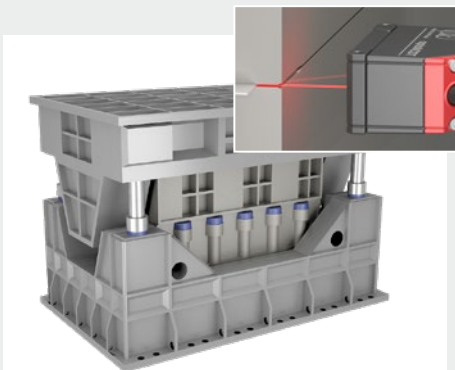

Monitoring the metal sheet infeed during pressing

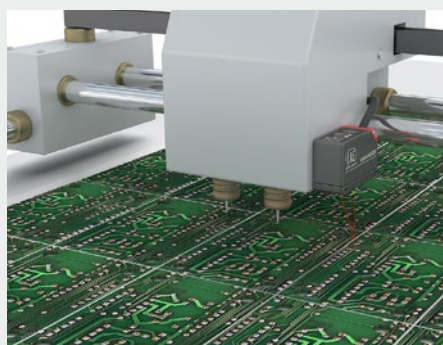

Measuring scribe lines on PCB panels

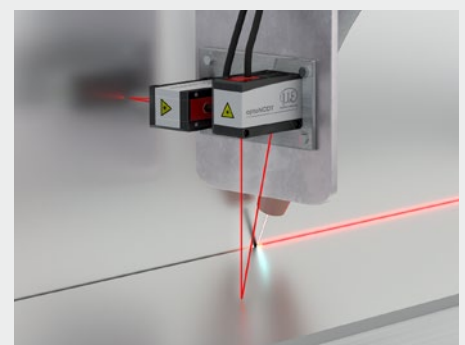

Distance control with laser welding



### optoNCDT 1220/1320

Compact laser triangulation sensor for high speed, precision measurements

Measuring ranges (mm)	10   25   50   100
Linearity	≤ ±0.1% FSO
Repeatability	from 1 μm
Measuring rate	1 kHz   2 kHz



### optoNCDT 1420/1420 CL1

Smart laser triangulation displacement sensor for fast and precise measurements

Measuring ranges (mm)	10   25   50   100   200   500
Linearity	≤ ±0.08% FSO
Repeatability	from 0.5 μm
Measuring rate	4 kHz



**PROFINET**  
**EtherCAT**  
**EtherNet/IP**

### optoNCDT 1900

Innovative laser sensor for advanced automation

Measuring ranges (mm)	2   10   25   50   100   200   500
Linearity	< ±0.02 % FSO
Repeatability	from 0.1 μm
Measuring rate	10 kHz

Now with integrated EtherCAT, EtherNet/IP and PROFINET interfaces



### optoNCDT 1750/1750-DR

Universal sensor with integrated controller for industrial applications

Measuring ranges (mm)	2   10   20   500   750
Linearity	≤ ±0.06% FSO
Repeatability	from 0.1 μm
Measuring rate	7.5 kHz



### optoNCDT 1750BL/2300BL/2300-2DR

Laser sensor with Blue Laser Technology for metals and organic materials

Measuring ranges (mm)	2   5   20   50   200   500   750   1000
Linearity	≤ ±0.03% FSO
Resolution	0.0015 % FSO
Measuring rate	49 kHz



### optoNCDT 2300

Highly dynamic laser sensor in the 50 kHz class

Measuring ranges (mm)	2   5   10   20   50   100   200   300
Linearity	≤ ±0.02% FSO
Resolution	0.0015 % FSO
Measuring rate	49 kHz



### optoNCDT 1420LL / 2300LL / 1900LL

Laser sensors for shiny metallic and structured surfaces

Measuring ranges (mm)	2   10   20   25   50
Linearity	≤ ±0.02% FSO
Resolution	0.0015 % FSO
Measuring rate	49 kHz



### optoNCDT 1710 / 2310

Long-range sensors for large distances

Measuring ranges (mm)	10   20   40   50   1000
Linearity	≤ ±0.03% FSO
Resolution	0.005 % FSO
Measuring rate	49 kHz

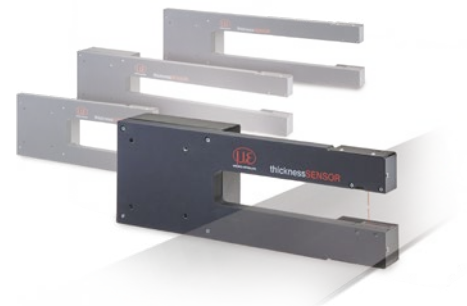

### thicknessSENSOR

Sensor for non-contact thickness measurements of strip and plate materials

Measuring ranges (mm)	10   25
Linearity	±0.01 % FSO
Measuring rate	4 kHz
Measuring widths (mm)	200   400

# Confocal chromatic sensors

for high precision displacement & thickness measurements

## confocalDT

- Distance measurement with extremely high resolution and measuring rate
- Precise thickness measurement of transparent materials with up to 5 layers
- Extremely high resolution
- Suitable for all surfaces
- Extremely small, constant spot size
- Compact beam path
- Vacuum-suitable sensor design
- Numerous interfaces, also for bus connection



The confocalDT product range stands for the highest precision and dynamics in confocal chromatic measurement technology. The measuring system includes the worldwide fastest controller currently available, which in combination with the sensors enables high precision measurement results in displacement and distance measurement tasks, as well as thickness measurement of transparent objects. A large number of sensors and different interfaces can be used in versatile measurement tasks, e.g., in the semiconductor industry, glass industry, medical engineering and machine building.

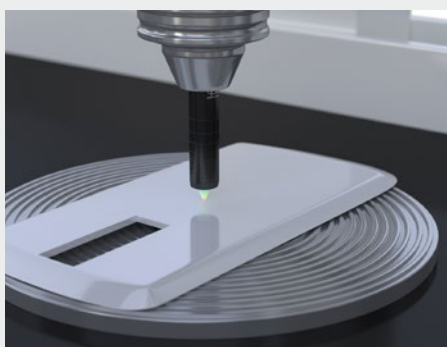

Roughness measurement and geometry inspection in coordinate measuring machines

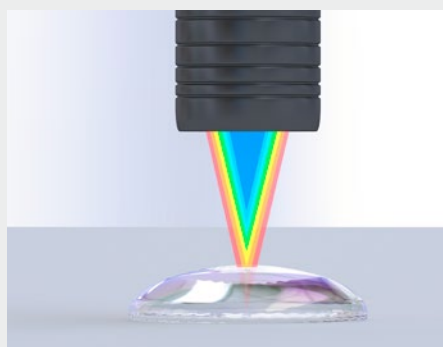

Measuring the curvature of lenses

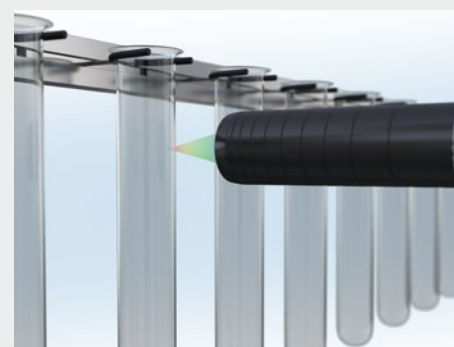

Wall thickness of medical glass containers



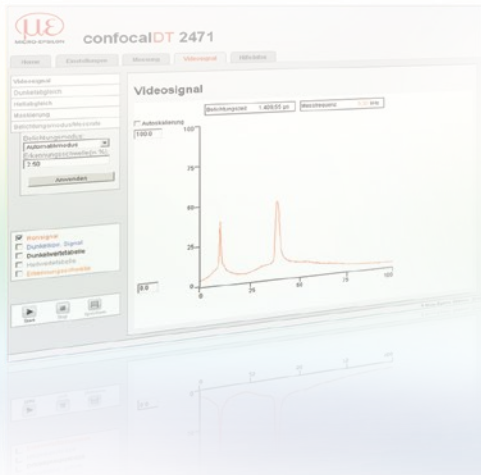

**confocalDT 2421/2422**

Single and dual-channel controller with integrated light source for industrial applications and measuring rates up to 6.5 kHz

**confocalDT 2471 HS**

High-speed controller with integrated light source for measuring rates up to 70 kHz

**confocalDT 2465/2466**

Light-intensive controller for high measuring rates up to 30 kHz

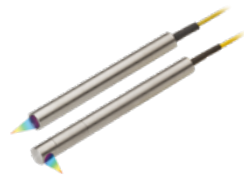

**IFS2402**

Miniature sensors (gradient index lens) for the inspection of smallest inner bodies

Measuring ranges (mm)	0.4   1.5   2.5   3.5
-----------------------	-----------------------

available with axial / radial beam path

**IFS2403**

Confocal hybrid sensors with narrow gradient index lens and relay lens

Measuring ranges (mm)	0.4   1.5   4   10
-----------------------	--------------------

Resolution 0.0015 % FSO

available with axial / radial beam path

**IFS2404**

Confocal chromatic sensors for high precision applications in restricted spaces

Measuring ranges (mm)	2
-----------------------	---

Resolution (µm) 0.04

available with axial / radial beam path



**IFS2405**

Standard sensors for precise distance and thickness measurements

Measuring ranges (mm)	0.3   1   3   6   10   28   30
-----------------------	--------------------------------

Large offset distance and tilt angle

**IFS2406**

Confocal chromatic compact sensors for displacement & thickness measurements

Measuring ranges (mm)	2.5   3   10
-----------------------	--------------

available with axial / radial beam path

**IFS2407**

Confocal sensors for precise displacement, thickness & roughness measurements

Measuring ranges (mm)	0.1   0.3   0.8   3
-----------------------	---------------------

Small measurement spot and large tilt angle

available with axial / radial beam path

# High-precision white light interferometer

for non-contact distance and thickness measurements

## interferoMETER

- Absolute distance measurement and multi-peak distance measurement
- Distance-independent thickness measurement & multi-layer thickness measurement
- Best-in-Class: resolution < 30 picometers and outstanding linearity
- High signal stability due to new evaluation algorithms and active temperature compensation
- Simple parameter set up via web interface
- Numerous interfaces, also for bus connection

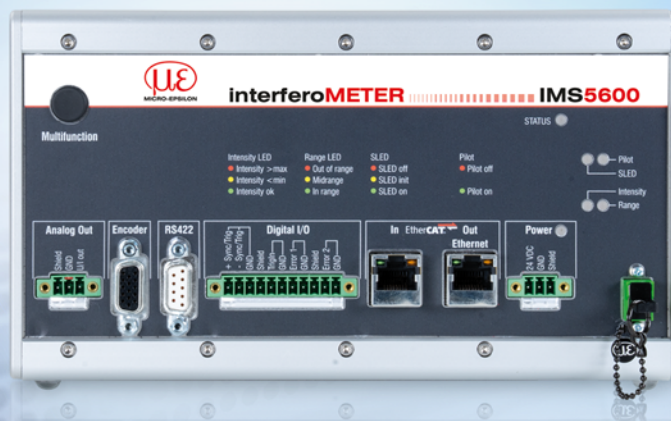

The innovative white light interferometers from Micro-Epsilon set a benchmark in high-precision distance and thickness measurements. These sensors enable stable measurement results with sub-nanometer resolution offering a comparatively large measuring range and offset distance. The interferometers are available in 3 series: the IMS5400-DS for high-precision industrial distance measurements, the IMS5400-TH for accurate thickness measurements and the vacuum-suitable IMS5600-DS for distance measurements with picometer resolution.

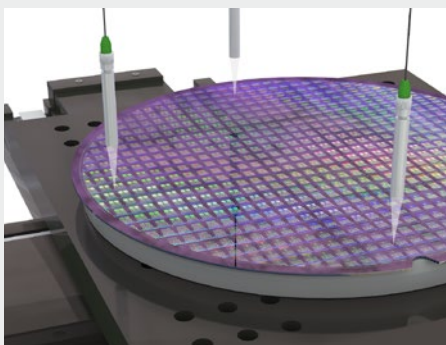

Inspection of wafer tilt angle

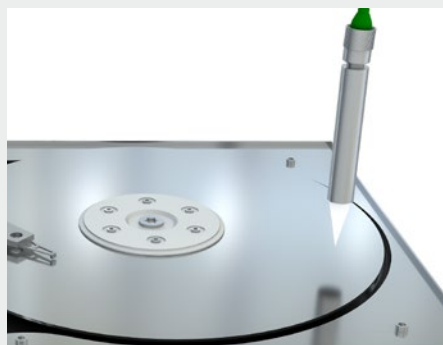

Inspecting the axial runout of hard drives

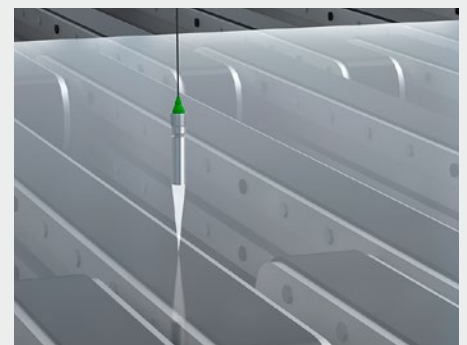

Thickness measurement of flat glass



**interferoMETER 5400-DS**

White light interferometer for absolute distance measurement with nanometer accuracy

Measuring range	2.1 mm
Linearity	< ±50 nm
Resolution	< 1 nm
Measuring rate	up to 6 kHz
Multi-peak distance measurement (thickness calculation)	



**interferoMETER 5400-TH**

White light interferometer for stable thickness measurement with submicron accuracy

Working distance	45 mm ±3.5 mm 70 mm ±2.1 mm
Linearity	< ±100 nm
Resolution	< 1 nm
Measuring rate	up to 6 kHz
Multi-peak thickness measurement	



**interferoMETER 5600-DS**

White light interferometer for absolute distance measurement with subnanometer accuracy

Measuring range	2.1 mm
Linearity	< ±10 nm
Resolution	< 30 pm
Measuring rate	up to 6 kHz
Multi-peak distance measurement (thickness calculation)	

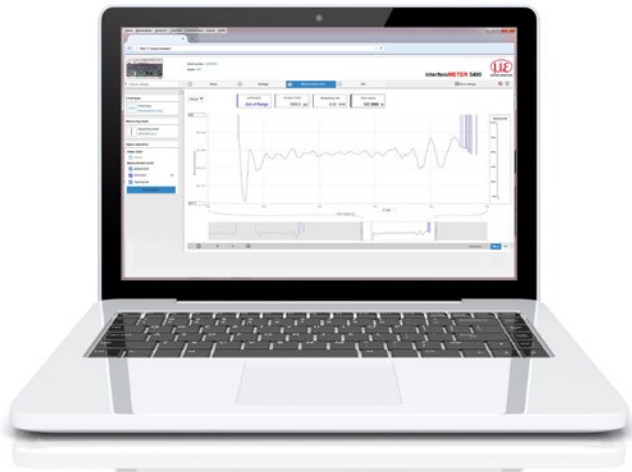

**Ease of use via web interface**

Due to a user-friendly web interface, no additional software is necessary to configure the controller and the sensors. The web interface is accessible via Ethernet connection and enables quick and easy setting of, e.g., averaging, measuring rate and presets.

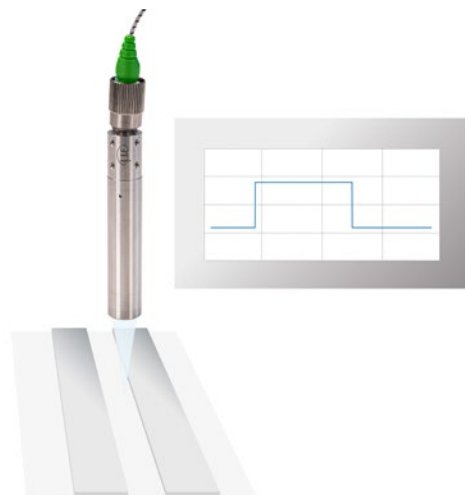

**Absolute measurement of step profiles**

Unlike interferometers based on relative measurements, the IMS-DS also enables the measurement of step profiles. Thanks to the absolute measurement, the scanning is performed with high signal stability and precision. When measuring on moving objects, the differences in height of heels, steps and depressions can thus be reliably detected.



Thickness measurement of plastic films

**Integration in industrial environments**

Robust sensors and a controller enclosed in metal make the interferometer ideal for integration into production lines and machines. These compact sensors are extremely space-saving and can also be integrated in confined spaces. The controller is installed in the control cabinet via DIN rail mounting and provides very stable measurement results due to active temperature compensation and passive cooling.

# Laser distance sensors

for the precise measurement of large distances

## optoNCDT ILR

- Precise measurement of displacement, distance & position on different surfaces
- Very large measuring range
- High repeatability
- Fast response time
- Excellent price/performance ratio
- Open interfaces



Optoelectronic optoNCDT ILR sensors are designed for non-contact distance and displacement measurements with large measuring ranges. Depending on the application and the required measuring range, the sensors detect diffuse reflecting surfaces or special reflector plates. Thanks to their robust design, optoNCDT ILR sensors are suitable for measurement tasks indoors and also outdoors.



Position detection for robots

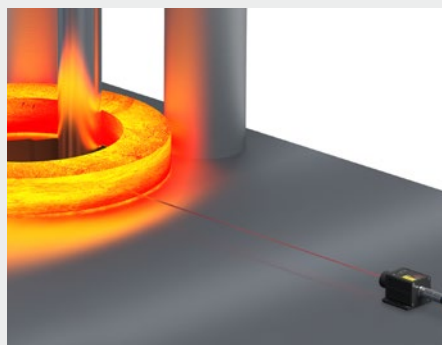

Diameter monitoring on seamless rolled rings



Acquisition of coil diameters

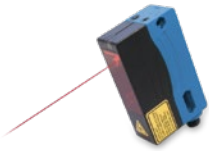

**optoNCDT ILR 1030/LC1 and 1031/LC1**  
Compact laser distance sensors

Measuring range	no reflector 0.2 - 15 m with reflector 0.2 - 50 m
Linearity	±20 mm
Repeatability	< 3 mm
Response time	10 ms

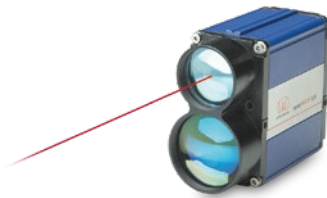

**optoNCDT ILR 1191**  
Laser distance sensors

Measuring range	0.5 - 3000 m
Linearity	±20 mm
Repeatability	<20 mm
Response time	0.5 ms



**IO-Link**  
inside

**optoNCDT ILR 2250**  
Compact laser distance sensors

Measuring range	0.5 - 150 m
Linearity	±1 mm
Repeatability	< 300 μm
Measuring rate	20 Hz

Measurement is performed directly onto the target



Measurement against a reflector which is installed on the target



Reflector

	ILR	1030	1031	1191	2250
Measuring range in gauging mode (without reflector)	8 m	•			
	15 m	•			
	50 m				
	100 m				•
	300 m			•	
Measuring range with reflector	50 m		•		
	150 m				•
	3000 m			•	

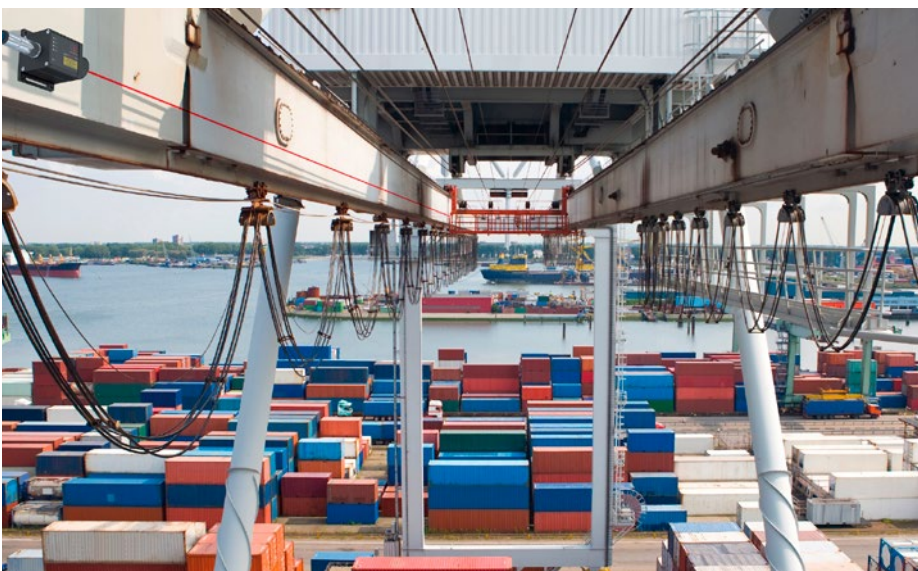

optoNCDT ILR sensors are particularly suitable for filling level measurement, safety applications, height measurement of lifting systems, overhead conveyors, crane systems and for positioning lifts.

# Capacitive sensors

for non-contact displacement & distance measurements

## capaNCDT

- Non-contact measurement of displacement, distance and thickness as well as on electrical conductors and insulators
- Resolution down to the nanometer range
- Temperature stability over a large temperature range
- World's most modern product portfolio for a wide range of laboratory and industrial applications
- Numerous interfaces, also for bus connection

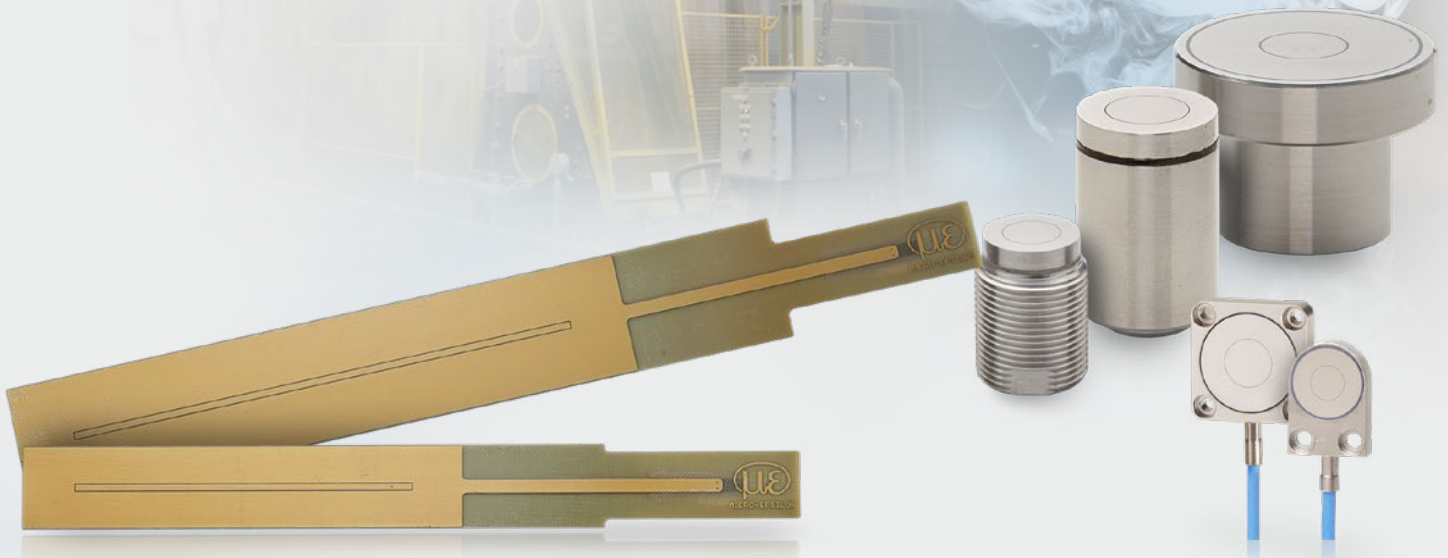

Capacitive sensors are designed for non-contact displacement and distance measurements with the highest precision and are used for measurement tasks in the laboratory as well as in industrial applications. Their special sensor design, triaxial sensor cables and innovative controller technology result in a perfectly matched measuring system. For this reason, capacitive sensors from Micro-Epsilon stand for the highest precision and signal stability. Even in industrial applications, capacitive sensors achieve resolutions in the submicrometer range.

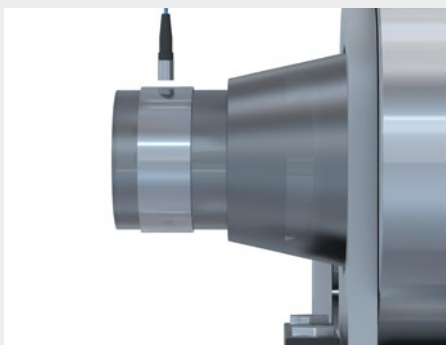

Measuring the bearing gap in roll drives

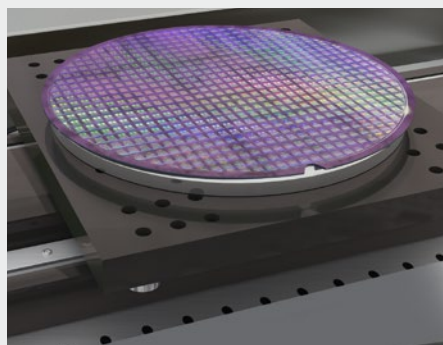

Positioning of precision stages

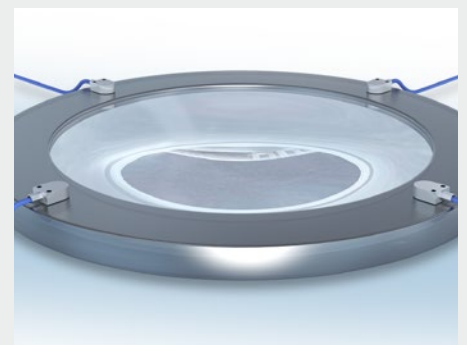

Checking the tilt angle of lens carriers



**capaNCDT 6110**  
Compact single-channel system

Measuring ranges (mm)	0.05   0.2   0.5   0.8   1   2   3   5   10
Linearity	$\leq \pm 0.05\%$ FSO
Resolution	0.01 % FSO
Frequency response	up to 20 kHz (-3dB)



**capaNCDT 61x0/IP**  
Measuring system for industrial applications

Measuring ranges (mm)	0.5   1   1.25   2   3   4   6
Linearity	$\leq \pm 0.1\%$ FSO
Resolution	0.01 % FSO
Frequency response	1 kHz (-3dB)



**capaNCDT 6200**  
Modular multi-channel system

Measuring ranges (mm)	0.05   0.2   0.5   0.8   1   2   3   5   10
Linearity	$\leq \pm 0.025\%$ FSO
Resolution	0.0005 % FSO
Frequency response	up to 20 kHz (-3dB)



**capaNCDT 6500**  
Modular multi-channel system

Measuring ranges (mm)	0.05   0.2   0.5   0.8   1   2   3   5   10
Linearity	$\leq \pm 0.025\%$ FSO
Resolution	0.000075 % FSO
Frequency response	8.5 kHz (-3dB)



**capaNCDT 61x4**  
Active sensor system, ideal for long signal transmission paths up to 15 m  
Sensor cable for use on drag chains and robots  
Easy integration due to flexible cable routing  
Robust sensor design



**capaNCDT DTV**  
Measuring the Disc Thickness Variation of brake discs  
Multi-channel controller for multi-track thickness measurements  
High dynamics up to 20 kHz  
Robust sensor design for long-life operation  
Comprehensive software package for ease of use and real-time evaluation of measurement results  
Analog interfaces, Ethernet, EtherCAT

### Large range of capacitive sensors

Capacitive displacement sensors from Micro-Epsilon are available in different designs and versions. They differ with respect to measuring range, design and manufacturing technology. Capacitive sensors are available in a cylindrical design (with integrated cable or socket) or as flat sensors (with integrated cable). These sensors can be exchanged without recalibration; the sensor replacement can be completed rapidly. Most sensors can be used in clean rooms as well as in ultra-high vacuums.



#### Adaption of sensors to OEM serial applications

- Shape & size
- Sensor material
- Cable
- Vacuum suitability
- Cryogenic or high temperatures
- Integrated controller with sensor for OEM design



Other capacitive sensors for special measurement tasks on page 37

# Inductive sensors (eddy current)

for high precision displacement & distance measurements

## eddyNCDT

- Non-contact and wear-free
- High resolution and linearity
- Stable measurement signals
- High dynamics
- Excellent temperature range and temperature stability
- For industrial applications
- Numerous interfaces, also for fieldbus connection

For many years, Micro-Epsilon has been a pioneer in displacement measurement using eddy current technology. eddyNCDT displacement sensors are designed for non-contact measurement of displacement, distance, position, oscillation, vibrations etc. Considered as extremely robust and precise, eddy current sensors from Micro-Epsilon are preferably used in industrial environments. eddyNCDT sensors are based on the eddy current principle and are used for measurements on metallic targets. They enable non-contact and wear-free measurements without exerting any forces onto the measuring object. The insensitivity to, e.g., oil, dirt, water or electromagnetic interference fields makes eddyNCDT sensors ideal for measurement tasks in which precise measurements are required despite harsh industrial environments.

### Extreme temperature stability

Eddy current sensors from Micro-Epsilon can be used in a wide temperature range, some models from  $-50\text{ }^{\circ}\text{C}$  to  $+350\text{ }^{\circ}\text{C}$ . Their wide temperature range and insensitivity to dirt or dust enable a variety of applications in industrial environments. Active temperature compensation ensures the highest signal stability with fluctuating ambient temperatures.

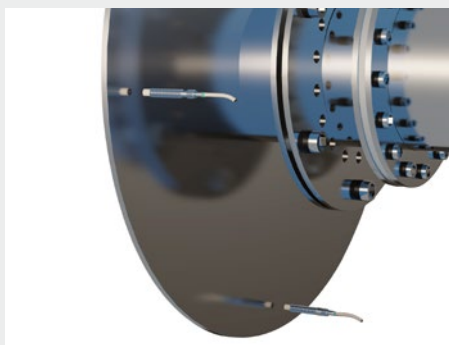

Measuring the radial runout of clutch discs

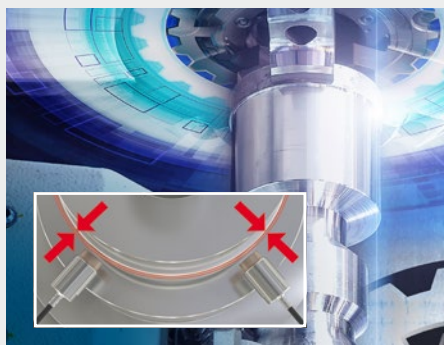

Measuring the spindle runout

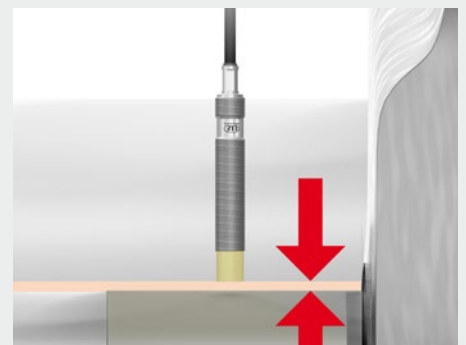

Monitoring the oil gap of drive shafts





### eddyNCDT 3001

Compact eddy current sensor with integrated controller

Measuring ranges (mm)	2   4   6   8
Linearity	< ±0.7 % FSO
Resolution	0.1 % FSO
Frequency response	5 kHz



### eddyNCDT 3005

Miniature eddy current measuring system ideal for integration into plant and machinery

Measuring ranges (mm)	1   2   3   6
Linearity	< ±0.25 % FSO
Resolution	0.05 % FSO
Frequency response	5 kHz (-3dB)



### eddyNCDT 3060/3070

A new performance class in inductive displacement measurements

Measuring ranges (mm)	0.4   0.8   1   2   3   4   6   8
Linearity	< ±0.1 % FSO
Resolution	0.002 % FSO
Frequency response	20 kHz (-3dB)

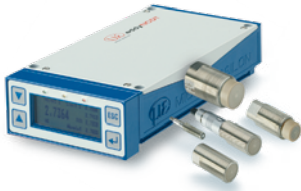

### eddyNCDT 3300

High precision eddy current system for industrial applications

Measuring ranges (mm)	0.4   0.8   1   2   3   4   6   8   15   22   40   80
Linearity	< ±0.2 % FSO
Resolution	0.005 % FSO
Frequency response	100 kHz (-3dB)
Standard and miniature sensors	



### Largest sensor range worldwide

Our long-term technology leadership in the field of eddy current sensor technology is reflected by the range of products - more than 400 sensors are available in different designs for different applications. The range includes miniature sensors which achieve high precision measurement results with the smallest possible dimensions.

For special requirements that are not met by standard models, the standard sensors can be modified accordingly. Cost-effective implementation can already be achieved with medium-sized quantities. For special applications where large quantities are required, Micro-Epsilon develops sensors that are precisely tailored to the customer's requirements.

### Adaption of sensors for small and large series

- Shape & size
- Sensor material
- Cable
- Connector
- Vacuum suitability
- Sensor with integrated controller



Other eddy current sensors for special measurement tasks on page 37

# Linear inductive displacement sensors

for industrial measurement tasks

## induSENSOR

- More than 250 different models with measuring ranges from 1 to 630 mm
- Integrated or separate controller
- High accuracy
- Extreme stability and durability
- Different designs with plunger, tube or measuring ring
- Analog output, digital interfaces and fieldbus connection
- Ideal for customer-specific designs and serial applications



For decades, Micro-Epsilon has been renowned for its inductive displacement sensors and gauges and has extended the range of proven measurement techniques such as, e.g., LVDT by further innovative developments. induSENSOR displacement sensors from Micro-Epsilon are used extensively in applications for automated processes, quality assurance, test rigs, hydraulics, pneumatic cylinders, and building monitoring. Typical measurement tasks require a long service life and reliability.

The induSENSOR models stand out due to their robustness and reliability under harsh conditions. As they provide high signal quality, temperature stability, resistance to shocks and vibrations as well as insensitivity to dirt and humidity, these sensors are the preferred choice for industrial measurement tasks.

induSENSOR systems are universally applicable and have been tried and tested in various industries. When several measuring points are required, the 2-channel controllers or multi-channel systems are used that are equipped with digital interfaces and, in addition, enable integration into fieldbus environments.



Stress and bending tests for material experiments

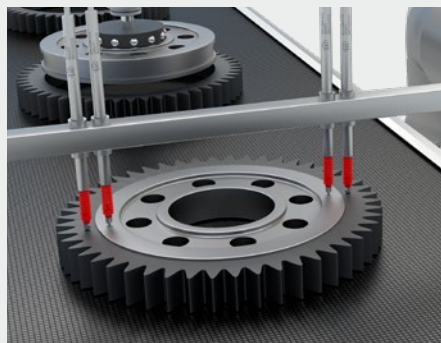

Checking the offset of gears



Lift height measurement in pneumatic cylinders



#### induSENSOR LVDT series

Gauging sensor with external controller

Measuring ranges (mm)	±1   3   5   10
Linearity	±0.3 % FSO
Frequency response	300 Hz (-3dB)
Target	Plunger with spring



#### induSENSOR LVDT series

Displacement sensors with external controller

Measuring ranges (mm)	±1   3   5   10   15   25
Linearity	±0.15 % FSO
Frequency response	300 Hz (-3dB)
Target	Plunger



#### induSENSOR LDR series

Linear displacement sensors with external controller for high temperatures up to 160 °C

Measuring ranges (mm)	10   25   50
Linearity	±0.30 % FSO
Frequency response	300 Hz (-3dB)
Target	Plunger



#### induSENSOR EDS series

Displacement sensors with integral controller

Measuring ranges (mm)	75   100   160   200   250   300   370   400   500   630
Linearity	±0.3 % FSO
Resolution	0.05 % FSO
Frequency response	150 Hz (-3dB)
Target	Measuring tube
Pressure resistance	450 bar



#### Miniature sensor controller for inductive displacement sensors

The MSC controllers are designed to be operated with LVDT and LDR measuring gauges and displacement sensors. Due to the robust and compact aluminum housing, the controllers are ideal for industrial measurement tasks. A wide variety of compatible, inductive displacement sensors and gauges combined with an optimized price/performance ratio opens up numerous fields of applications in automation technology and machine building.

For special requirements that are not met by standard models, the standard sensors can be modified accordingly. Cost-effective implementation can already be achieved with medium-sized quantities. For special applications where large quantities are required, Micro-Epsilon develops sensors that are precisely tailored to the customer's requirements.

#### Adapted to ambient conditions

Depending on the location of use, environment, and application, different influences prevail to which the sensors are adapted.

- Ambient temperature
- Pressure
- Interference fields
- Dirt, dust, and moisture
- Vibration, shock
- Seawater, IP69K



# Magneto-inductive distance sensors

for industrial measurement tasks

## mainSENSOR

- Ideal alternative to inductive sensors and proximity sensors
- Linear output signal, high basic sensitivity and temperature stability
- High dynamics
- Measuring range can be adjusted via magnets
- Ideal for customer-specific designs and serial applications



mainSENSOR distance sensors use an innovative measuring principle, which combines the advantages of both inductive and magnetic sensors. Measuring the distance to a magnet which is attached to the measuring object, the sensor outputs a continuous, linear output signal. By using magnets of different strengths, measuring ranges between 20 mm and 55 mm can be achieved. In order to adapt the measuring range, you only have to change the magnet.

Magneto-inductive sensors are frequently used as an alternative to inductive sensors and proximity sensors in process automation, the packaging industry and in machine monitoring. Their sensor design brings numerous application possibilities, especially for OEM series applications. The sensor is available as simple PCB, in a plastic housing or in housings made from stainless steel, which are resistant to many chemicals as well as oil or dirt.



Load measurement in washing machines

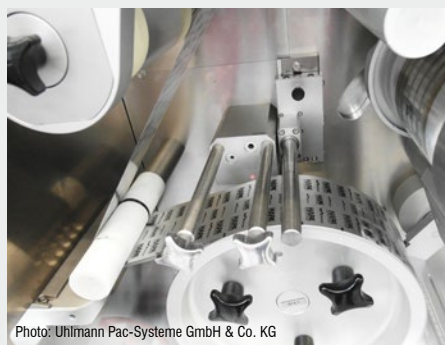

Photo: Uhlmann Pac-Systeme GmbH & Co. KG

Foreign body detection in blister packs



Photo: SIG Combibloc Group AG

Valve lift measurement in the food industry



#### MDS-45-M18-SA

Measuring range	20 - 55 mm*
Output	2 - 10 V
Linearity	< ±3 % FSO
Resolution	0.05 % FSO
Pressure resistance	up to 400 bar (front)
Frequency response	3 kHz (-3dB)



#### MDS-45-M12

Measuring range	20 - 55 mm*
Output	2 - 10 V
Linearity	< ±3 % FSO
Resolution	0.05 % FSO
Axial cable output or connector	
Frequency response	3 kHz (-3dB)



#### MDS-45-M30-SA

Measuring range	20 - 55 mm*
Output	2 - 10V / 4 - 20 mA
Linearity	< ±3 % FSO
Resolution	0.05 % FSO
Pressure resistance	50 bar (front)
Frequency response	1 kHz (-3dB)



#### MDS-35-M12-HT

Measuring range	20 - 55 mm*
Output	2 V ±0.4 V ... 9.6 V ±0.4 V
Linearity	< ±5 % FSO
Resolution	< 0.05 % FSO
Axial cable output or connector	
Frequency response	5 kHz (-3dB)
Temperature range	up to 120 °C



#### MDS-40-MK

Measuring range	approx. 40 mm*
Output	different kinds
Linearity	< ±3 ... < ±5 % FSO
Resolution	0.05 % FSO
Number of pieces	from 1 or 10 pcs. / freely configurable from 200 pcs.



#### MDS-40-LP

Measuring range	approx. 40 mm*
Output	square
Linearity	< ±9 % FSO
Resolution	0.05 % FSO
Number of pieces	2,000 or 5,000 pcs./year

\*depends on the magnet



#### Accessories

Measuring ranges of magnets: 20 mm, 27 mm, 35 mm, 45 mm, 55 mm  
Power and output cables with M8x1 connector in different types

#### Flexible sensor design for OEM applications

Due to the flexible sensor design and the significant advantages of this physical measuring principle, various possibilities are available for adjusting the sensor to specific high volume applications. In OEM projects, the requirements of certain applications can be met at a very competitive price level.

- Improved dynamics
- Different shapes and materials for the housing
- Various output signals
- Special features such as pressure resistance, integrated cables, etc.

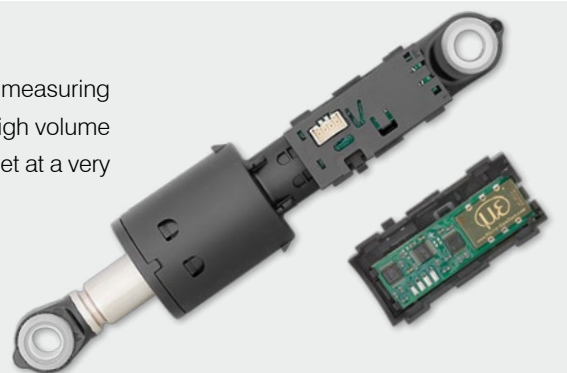

# Draw-wire sensors

for displacement, position and length

## wireSENSOR

- Measuring displacement, distance and position up to 50,000 mm
- Compact sensor housing combined with a large measuring range
- Ideal for difficult-to-access positions
- Easy, fast and flexible mounting
- Robust design, also for outdoors
- Excellent price/performance ratio
- Ideal for customized OEM series



Draw-wire sensors from Micro-Epsilon enable the measurement of long displacements with a small sensor size. Draw-wire displacement sensors measure the linear movement of a component using a wire made from highly flexible stainless steel strands, which is wound onto a drum by means of a long-life spring motor. The wire is attached directly to the measuring object and can also be guided over deflection pulleys to reach installation spaces that are difficult to access. The winding drum is axially coupled with a multi-turn potentiometer, an incremental encoder, or an absolute encoder.

Different sensor designs range from easy low-cost models to extremely robust designs for industrial applications. wireSENSOR models stand out due to their optimized ratio between measuring range and size, easy installation and handling. Their robust sensor design enables reliable measurements even in challenging ambient conditions.



Synchronization monitoring with draw-wire sensors in telescopic platforms



Measuring the deformation of rotor blades for wind turbines



Vibration monitoring of cranes



**wireSENSOR**  
**MK30 / MK46 / MK77 / MK60 / MK88 / MK120**  
 OEM miniature sensors with plastic housing

Measuring ranges (mm)	50   150   250   500   750
	1000   1250   1500   2100   2300   2400   3000   3500   5000   7500
Analog outputs	Potentiometer, voltage, current
Digital output	Encoder



**wireSENSOR MT**  
 Miniature draw-wire sensors with aluminum housing

Measuring ranges (mm)	40   80   130
Analog output	Potentiometer
Miniature sensor size	



**wireSENSOR MPM/MP/MPW**  
 Robust miniature sensors with aluminum housing

Measuring ranges (mm)	50   100   150   250   300   500   1000
Analog output	Potentiometer
Option with wire acceleration up to 100 g	
Option with protection class IP67	



**wireSENSOR P60/P96/ P115**  
 Industrial sensors with aluminum housing

Measuring ranges (mm)	100   150   300   500   750   1000   1500   2000   2500   3000   4000   5000   7500   10,000   15,000
Analog outputs	Potentiometer, voltage, current
Digital outputs	HTL, TTL, SSI, PB, CO



**wireSENSOR P200**  
 Long-range industrial sensors with aluminum housing

Measuring ranges (mm)	30,000   40,000   50,000
Digital outputs	HTL, TTL, SSI, PB, CO



**wireSENSOR K**  
 OEM industrial sensors with plastic housing

Measuring ranges (mm)	1500   2500   3500   5000
Analog outputs	Potentiometer, voltage, current
Ideal for serial applications	

**wireSENSOR mechanics**

wireSENSOR mechanics are designed in such a way that they ensure easy mounting of an incremental or absolute encoder. Therefore, the user can individually choose the interface, resolution and connection type. Due to the robust housing, the draw-wire mechanisms are ideal for industrial use.

**WDS mechanics**

Draw-wire sensor mechanics for encoder installation

Measuring ranges (mm)	1,500   3,000   5,000   7,500   10,000   15,000   30,000   40,000   50,000
Housing	Plastics / aluminum
Output types	depending on encoder



## 2D/3D Laser profile sensors

with high accuracy and profile frequency

### scanCONTROL

- Compact size with integrated evaluation: no external controller required
- High profile resolution for the detection of finest details
- High profile rate for dynamic measurement tasks
- Patented Blue Laser Technology
- Powerful software for parameterization and visualization
- SDKs for integration in individual software environments
- SMART design with integrated evaluation

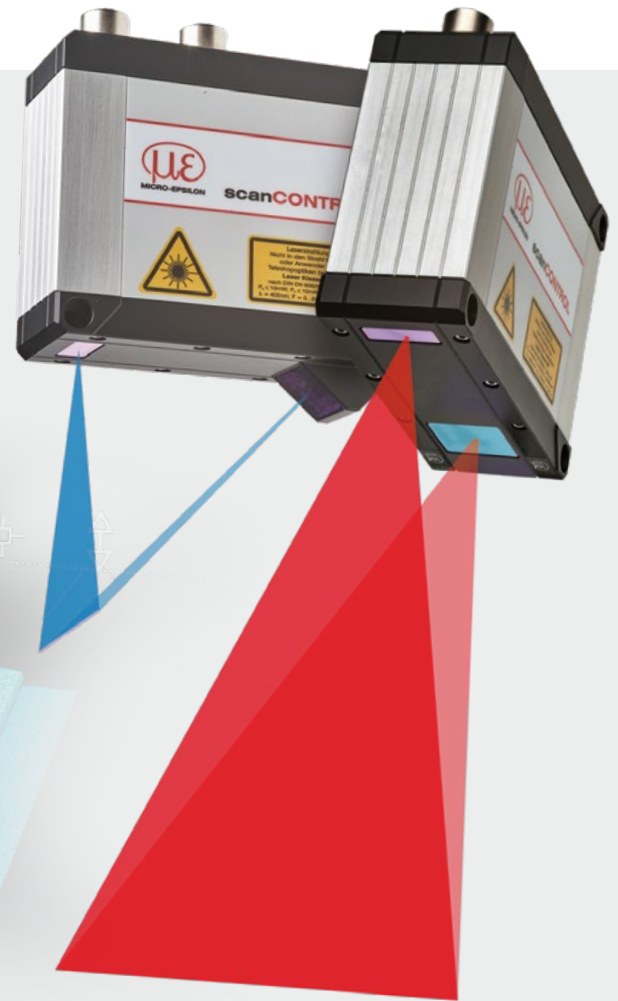

Laser scanners from Micro-Epsilon are among the highest performing profile sensors with respect to accuracy and measuring rate. They detect, measure and evaluate profiles on different object surfaces without contact. The available models are suitable for numerous industrial applications. The integrated intelligence in their sensor head (scanCONTROL SMART) solves versatile measurement tasks. Models for the customer's own programming are available for system integrators. scanCONTROL profile scanners do not require any external controller, which considerably simplifies the installation effort.

Equipped with powerful processors and highly sensitive optical components, these scanners ensure precise profile measurements on almost any type of surface. While they can be integrated in numerous environments, the laser scanners also impress with their compact design which includes an integrated controller.



Measuring the inside of the rail



Gap and flushness measurement on bodywork parts

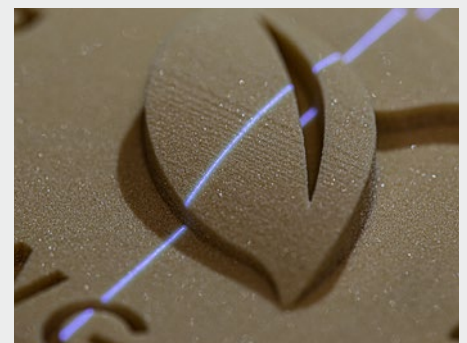

Quality inspection with 3D printing





**scanCONTROL 25xx**  
Laser scanner for serial applications

Measuring range	z-axis	up to 265 mm
	x-axis	up to 143.5 mm
Resolution	x-axis	640 points/profile
Profile frequency		up to 2,000 Hz



**scanCONTROL 29xx**  
Laser scanner with high precision

Measuring range	z-axis	up to 265 mm
	x-axis	up to 143.5 mm
Resolution	x-axis	1,280 points/profile
Profile frequency		up to 2,000 Hz



**scanCONTROL 30x2**  
Powerful 2D/3D laser scanners

Measuring range	z-axis	up to 300 mm
	x-axis	up to 290 mm
Resolution	x-axis	1,024 points/profile
Profile frequency		up to 5,000 Hz



**scanCONTROL 30x0**  
High-performance laser scanner

Measuring range	z-axis	up to 300 mm
	x-axis	up to 290 mm
Resolution	x-axis	2,048 points/profile
Profile frequency		up to 10,000 Hz

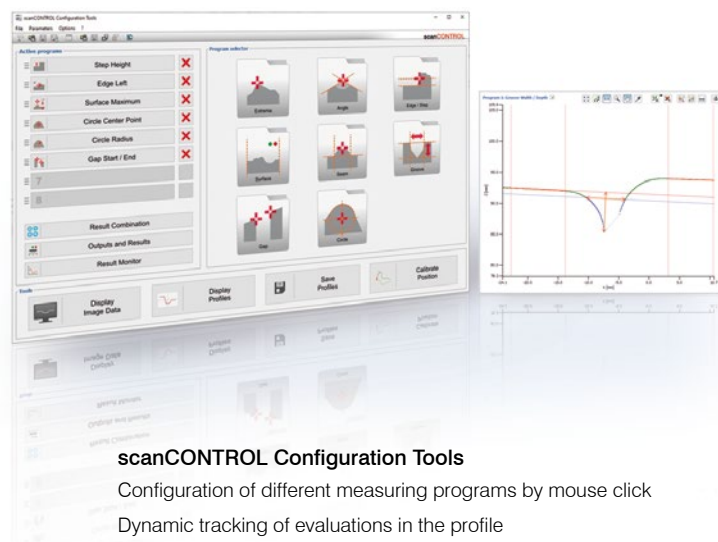

**scanCONTROL Configuration Tools**

- Configuration of different measuring programs by mouse click
- Dynamic tracking of evaluations in the profile
- Parameterizing outputs and displaying measured values
- Output of measured values across a large number of interfaces

**scanCONTROL 3D-View**

- Can be used with all scanCONTROL sensors
- Offline or real-time display of 3D profiles
- 2D export of profile sequences (.png)
- 3D export (.asc, .stl) for CAD programs
- Intensity per point can be displayed and exported

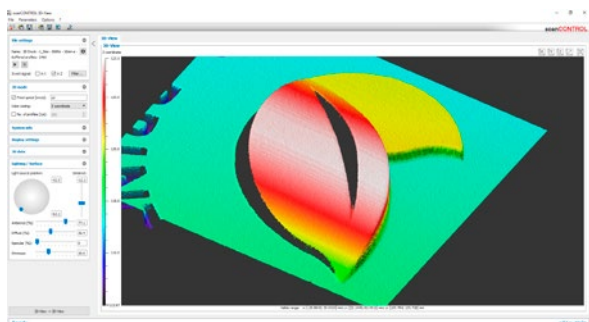

**scanCONTROL Software integration**

- Ethernet GigE Vision
- SDK for fast integration in C/C++ (Linux and Windows) or C# (Windows) applications
- Example VIs for NI LabVIEW for integration using LLT.DLL or NI IMAQdx

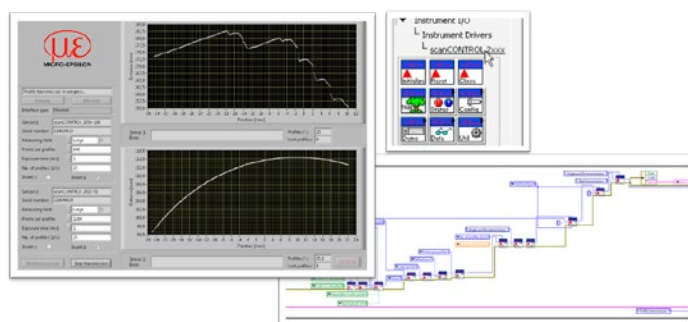

# Optical micrometers & fiber optic sensors

## optoCONTROL

- Various models for different applications
- Large working distance
- Compact designs with integrated controller
- High accuracy
- Large measuring ranges up to 95 mm
- Detection of edges, gaps, positions and diameters of round objects
- Inspection and detection of position and presence



Optical micrometers are primarily used for production control and quality monitoring, and continuously measure both endless material and single parts. The technologies used are suitable for a wide range of applications. The compact optoCONTROL models are suitable for applications in production lines, as well as for integration in testing machines and automated production systems. The high measuring rates ensure a high and continuous cycle rate in the production process.

All optoCONTROL models work without rotating mirrors and are therefore completely wear-free. The parallel light curtain is created by special optics in the light source. High quality components in the receiving optics, e.g. filters and lenses, enable the high accuracy of the micrometers. This is why optoCONTROL micrometers are particularly suitable for fields where high precision and reliability are required.



Diameter measurement at conical constrictions

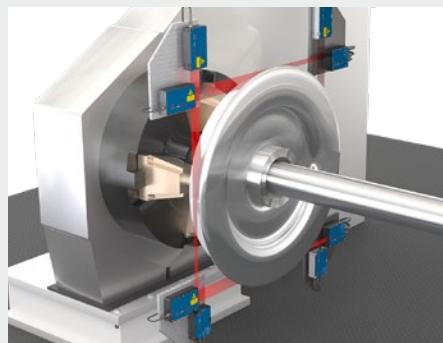

Ovality and roundness of wheelsets and wheel tires



Inspections of large-diameter tubes

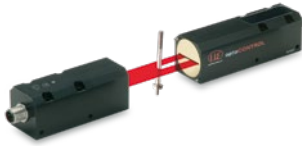

### optoCONTROL 1200

Compact high-speed micrometer (laser)

Measuring ranges (mm)	2   5   10   16   20   30
Linearity	$\pm 40 \mu\text{m}$ (independent)
Resolution	$10 \mu\text{m}$
Frequency response	100 kHz
Integrated controller	



### optoCONTROL 2500

High-resolution micrometer (laser)

Measuring range (mm)	34
Linearity	$\pm 10 \mu\text{m}$
Resolution	$1 \mu\text{m}$
Measuring rate	2.3 kHz
External controller	

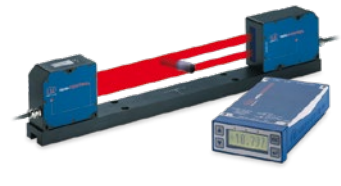

### optoCONTROL 2600

High-resolution micrometer (LED)

Measuring range (mm)	40
Linearity	$\pm 3 \mu\text{m}$
Resolution	$0.1 \mu\text{m}$
Measuring rate	2.3 kHz
External controller	



### optoCONTROL 2520

Compact laser micrometer (class 1M)

Measuring range (mm)	46   95
Linearity	$\pm 12 \mu\text{m}$
Resolution	$1 \mu\text{m}$
Measuring rate	2.5 kHz
Integrated controller (web interface)	



optoCONTROL 2520-46(090) and optoCONTROL 2520-95 (270) micrometers offer a receiver equipped with a lens that is turned by 90°. The flat design of the receiver simplifies the installation process in restricted spaces.

### optoCONTROL CLS1000

Fiber optic sensor for industrial applications

- Extremely robust and compact
- Numerous fiber optic sensors
- Large detection and operating ranges
- Extremely high resistance to ambient light
- Numerous teach-in modes and output types



# > High precision 3D measurement & surface inspection



With the surfaceCONTROL, reflectCONTROL and scanCONTROL sensor systems, Micro-Epsilon presents a new generation of 3D sensors which are based on a common software platform. These 3D sensors are used for high-resolution geometry and surface measurements and detect the measuring object by scan or by single snapshot, allowing fast inspection of matt and glossy surfaces. In contrast to conventional 3D systems with 2.5D evaluation, Micro-Epsilon's Valid3D technology enables a complete representation and precise evaluation of the 3D point cloud.

These 3D sensors are used, e.g., for geometric component testing, position determination, presence checks and the measurement of flatness or planarity. Thanks to their high performance, the sensors are used for inline applications, on robots and also for offline inspection.



3D inspection of components



3D shape measurement of wafers

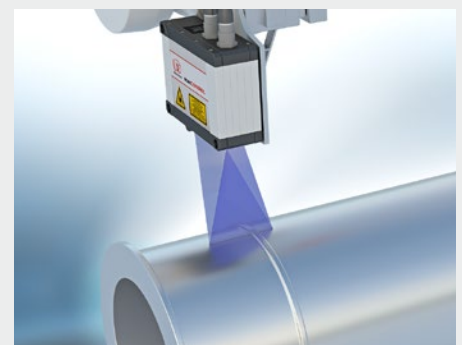

Scan of components before laser cladding



**surfaceCONTROL 3D 3200/3500**

3D sensor for the inspection of geometry, shape and surfaces  
 Highest precision in z up to  $< 0.4 \mu\text{m}$   
 Complete 3D images from 0.2 s  
 Micrometer-accurate snapshots with large measuring fields



**surfaceCONTROL 3D 2500**

3D inspection of large format surfaces  
 Large measuring fields  
 Detecting surface shape defects  
 Detection and evaluation of 3D surface data within a few seconds



**reflectCONTROL SENSOR**

Complete inspection of reflecting and shiny surfaces  
 Highest z-accuracy  $< 1 \mu\text{m}$   
 Detection and evaluation of 3D surface data within a few seconds



**reflectCONTROL Automotive**

Fully automatic surface inspection of painted car bodies  
 Ideal for large-surface and curved objects  
 Recognition of defects, inclusions, craters etc.



**scanCONTROL 3D**

Precise laser line scanners for 3D point clouds  
 Red laser & patented Blue Laser Technology  
 Up to 2048 points per profile  
 Measuring rates up to 10,000 kHz  
 One design for all measuring ranges



**The powerful solution for 3D measurement tasks**

The Industrial Performance Unit (IPU) is a powerful computing platform for the efficient commissioning of Micro-Epsilon 3D sensors. The 3DInspect software enables the parameter setting of the sensors and the point cloud evaluation. High compatibility to image processing environments is ensured via the GenICam standard.

# Precise color sensors, color measuring systems & LED Analyzers

## colorSENSOR / colorCONTROL

- Non-contact color measurement for industrial applications
- Precise and fast measurements even on poorly reflecting surfaces
- Numerous sensors for all tasks
- Measurement accuracies  $\Delta E$  up to 0.08
- Measurement frequencies up to 30 kHz
- Intuitive operation and configuration
- Ethernet and RS232 process interfaces



Color sensors from Micro-Epsilon are used for precise color measurements and color recognition. The sensors measure color values, intensities and functions on different surfaces. As a result, they are used in a variety of applications and stand for high productivity and cost reduction in manufacturing, automation and quality assurance.

colorSENSOR and colorCONTROL sensors are used for numerous measurement tasks. In addition to print mark recognition or batch testing, the sensors are used for measurement tasks that cannot be solved with other measurement processes. For example, the sensors check the presence of transparent coatings or determine the orientation of bottles based on an embossing mark. The MFA LED Analyzer also checks the function, color and intensity of LEDs, lamps or light sources. Thanks to the high accuracy and measuring rate, the range of applications is extremely diverse and can be found in numerous industries.

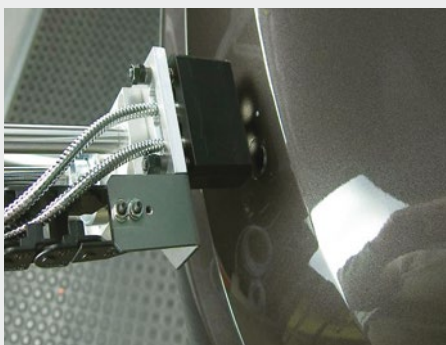

Checking the identical coloring of attachments in automotive production



Inspection of the interior coating in aluminum cans



Sorting of plastic components (connector colors)



### colorSENSOR CFO

Precise True Color Sensors for industry and automation

Repeatability  $\Delta E \leq 0.3$

Measurement speed max. 30 kHz

Color memory 320 colors in 254 color groups

Numerous sensors for all surfaces



### CFS sensors

with integrated optical glass fibers for adaptation to colorSENSOR CFO controller

Ambient temperature -40 ... 400 °C

Working distance 5 ... 320 mm

Measurement spot diameter 0.8 ... 70 mm



### colorSENSOR OT-3-LD

Color sensors with fixed lens for large measurement distances

Repeatability  $\Delta E \leq 0.9$

Switching frequency max. 35 kHz

Color recognition from a large distance up to 900 m



### colorCONTROL MFA

Sensor system for LED tests

Color distinction, intensity tests & function tests of LEDs

Available with either 7, 14, 21 or 28 measurement channels



### colorCONTROL ACS7000

Inline color measuring system for non-contact color measurements

Measurement geometries Transmission sensor, circular sensor, 30°/0° sensor

Repeatability  $\Delta E \leq 0.08$

Spectral measuring range 390 ... 780 nm

Measuring rate 2 kHz

Color recognition from a taught reference list

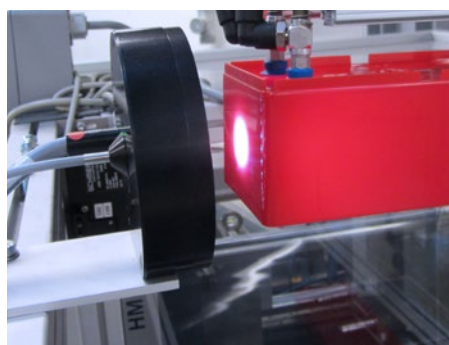

Inline color measurement of plastic injection-molded parts directly after demolding



Inline color gradient measurement of transparent film and acrylic glasses

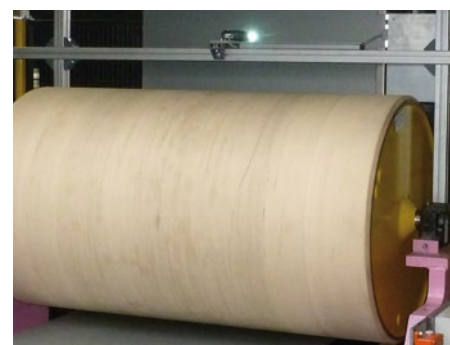

Color measurement of continuous strip coating such as aluminum, zinc and paper during production



# Non-contact infrared pyrometers

for industrial measurement tasks

## thermoMETER

- Infrared pyrometer for non-contact temperature measurement
- Temperature ranges from  $-50\text{ }^{\circ}\text{C}$  to  $1600\text{ }^{\circ}\text{C}$
- Compact design for non-contact temperature measurement without influencing the object
- Monitoring of hot, fast moving or difficult-to-access objects
- Robust, wear-free and reliable



Infrared pyrometers from Micro-Epsilon determine the object temperature without contact based on the infrared radiation emitted by the object. The thermoMETER series opens up numerous possibilities for measuring and displaying temperature curves in industrial fields of application. As this measurement is a non-contact technology, the pyrometers perform wear-free and can therefore be reliably used over long periods of time. Selectable models and optical systems enable the cameras to be installed in different distances from the surface. This allows for the target to be measured from a safe distance in critical areas of use.

### Pioneering infrared technology for industrial applications

thermoMETER pyrometers combine high accuracy with measurements in ambient temperatures of up to  $250\text{ }^{\circ}\text{C}$  without cooling. New infrared sensor elements with small dimensions and high sensitivity enable outstanding sensor characteristics with high measurement accuracy and short response time. Temperature sensors are mainly used in machine building, research and development, maintenance and process monitoring.



Temperature measurement in the plastics industry



Temperature measurement in the glass industry



Temperature measurement in the metals industry





**thermoMETER CS / CSmicro / CSLaser**

Compact, miniature and low cost  
 Temperature ranges from -50 °C to 1030 °C  
 Robust, silicon-coated lens  
 Integrated controller  
 Scalable analog output: 0 - 10V / 0 - 5V  
 Ideal for OEM, also available as two-wire version and high-resolution models



**thermoMETER CT / CTfast**

Extremely low cost and high accuracy  
 Temperature ranges from -50 °C to 975 °C  
 Short response times from 3 ms  
 Up to 180 °C ambient temperature without cooling



**thermoMETER CTM2/M3**

Version for metal production, temperature ranges from 50 °C to 1600 °C

**thermoMETER CTM4**

Fast measurement of metals and non-metals due to large, short-wave spectral range

**thermoMETER CThot**

for difficult ambient conditions up to 250 °C ambient temperature without cooling



**thermoMETER CTLaser / CTLaserFAST**

Precise pyrometer with laser sighting  
 Temperature ranges from -50 °C to 975 °C  
 Infrared sensor heads with optical resolution up to 75:1, from a measurement spot of 0.9 mm  
 Double laser marks the exact spot location from a spot size of 1 mm  
 Response time from 120 ms



**thermoMETER TIM 8**

Intelligent spotfinder pyrometer  
 Temperature ranges from -20 °C to 900 °C  
 Robust and compact pyrometer with motorized focus  
 Excellent optical resolution  
 Autonomous operation with automatic spotfinder and direct analog output  
 For temperature measurements in machine building and in automation

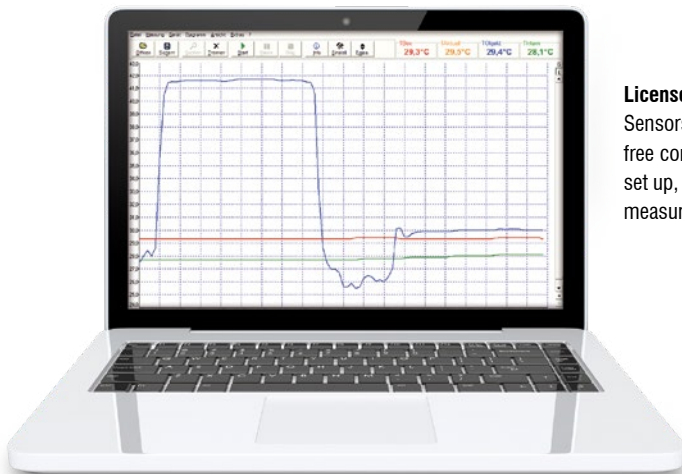

**License-free evaluation software**

Sensors with digital interfaces include the license-free compactCONNECT software for easy parameter set up, analysis and documentation purposes of measured temperature values.

# Compact thermal imaging cameras

for industrial measurement tasks

## thermoIMAGER

- Compact thermal imaging cameras for non-contact temperature measurement without affecting the object
- Temperature range from -20 °C to 1900 °C
- Monitoring of hot, fast moving or difficult-to-access objects
- Fast recognition of temperature deviations in power distribution systems, machines and production processes
- Powerful software included in delivery
- Software Developer Kit with examples, C, C++, C# included



thermoIMAGER infrared cameras are designed for industrial use. The cameras impress with their compact design and favorable price/performance ratio. They are available with different wavelengths optimized for different industries. Data is streamed in real time from the camera to the software via a USB interface. The powerful process and analysis software is included and enables the acquisition of thermal images at up to 128 Hz. The data can be stored in an image or video file and viewed and analyzed offline without a camera at a later time. In addition, the software can be used as a runtime application where the user is able to program and configure a custom environment (e.g. multiple monitoring windows, alarms, hot spot localization, line profiles). Advanced interface concepts enable integration into networks and automated systems.



Temperature monitoring in hot rolling mills

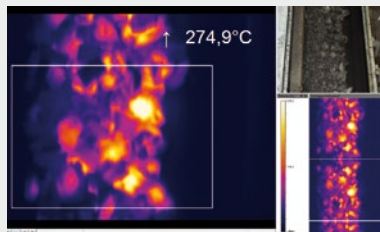

Monitoring a coal conveyor belt

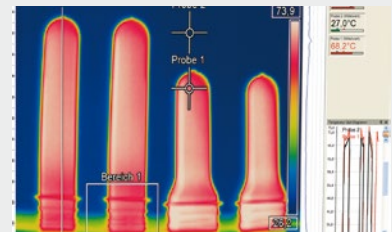

Thermal image shots of preforms in PET bottle production

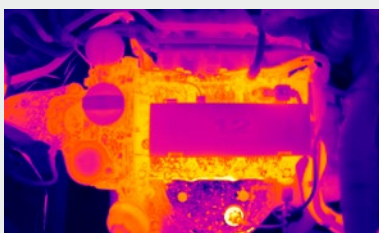

Razor-sharp infrared pictures and videos for process optimization

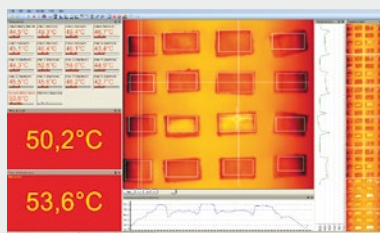

Exact temperature measurement on moving glass surfaces due to line scan feature

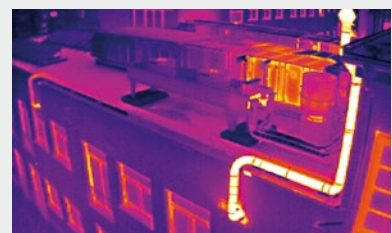

Temperature monitoring in building thermography



**thermoIMAGER TIM 160S**

Temperature ranges:  
 -20 °C to 900 °C (special variant 1500 °C)  
 Excellent thermal sensitivity (NETD) of 0.08 K  
 Exchangeable lenses  
 12°/30°/55°/80° FOV  
 Real-time thermography with 120 Hz frame rate via USB 2.0 interface  
 Extremely lightweight (195 g) and robust (IP67)  
 Extremely compact, 45 x 45 x 62 - 77 mm  
 Analog input and output, trigger interface



**thermoIMAGER TIM QVGA/QVGA-HD**

Detector with 382 x 288 pixels  
 Temperature ranges:  
 -20 °C to 900 °C (special variant 1500 °C)  
 Excellent thermal sensitivity (NETD) of up to 0.04 K  
 Exchangeable lenses & industrial accessories  
 Image recording in real time at 80 Hz  
 Analog input and output, trigger interface



**thermoIMAGER TIM 640 VGA**

Thermography with VGA resolution  
 640 x 480 pixels  
 Temperature ranges:  
 -20 °C to 900 °C (special variant 1500 °C)  
 Excellent thermal sensitivity (NETD) of 0.075 K  
 Radiometric video recording with 32 Hz  
 Analog input and output, trigger interface



**thermoIMAGER TIM M1/TIM M-08**

Thermal imaging camera for hot metal surfaces  
 Temperature ranges:  
 450 °C to 1900 °C  
 Excellent thermal sensitivity (NETD) of <1 K  
 Optical resolution 764 x 480 pixels  
 Spectral range 0.92 to 1.1 μm / 500 to 540 nm



**thermoIMAGER TIM 40**

Compact OEM thermal imaging camera  
 Optical resolution: 382 x 288 pixels  
 Temperature ranges: -20 °C to 900 °C  
 Frame rate up to 80 Hz  
 Excellent optical resolution and distance-to-spot-size-ratio up to 390:1  
 Lenses with 18°, 29°, 53°, 80° FOV



**thermoIMAGER Microscope lens**

Thermal imager with microscope lens  
 Measuring ranges:  
 -20 °C to 100 °C / 0 °C to 250 °C / 150 °C to 900 °C  
 Excellent thermal sensitivity (NETD)  
 90 mK or 120 mK  
 Optical resolution: 382x288 or 640x480 pixels  
 Smallest spot size: 42 μm / 28 μm  
 Spectral range: 7.5 to 13 μm



**thermoIMAGER NetPCQ**

Embedded, industrial PC solution with passive cooling for thermoIMAGER applications  
 Supports all thermoIMAGER TIM models  
 Integrated watchdog feature



**Cooling Jacket Advanced**

Universal cooling housing up to 315 °C  
 Ambient temperatures up to 315 °C  
 Air/water cooling with integrated air purging and optional protective windows  
 Modular concept for easy fitting of different cameras and lenses



# Innovative sensor technology

for specific applications



As well as standard sensors based on various measuring principles, Micro-Epsilon has developed numerous sensors for special applications, which go beyond pure displacement and position measurements.

These application-specific sensors were developed for special measurement tasks and have proven themselves there many times. These developments incorporate the many years of know-how that Micro-Epsilon has accumulated in the design and application of sensor technology. High performance, precision and reliability at cost-effective OEM conditions are the main focus.

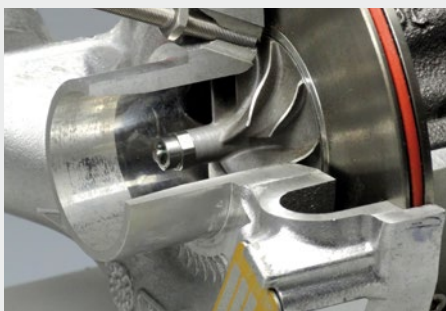

Rotational speed measurement of turbochargers



Measuring the thermal extension of spindles

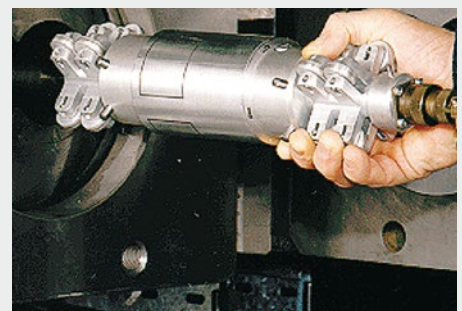

Inspection of the inner diameter of extruder housings



Inline yarn thickness measurement



Load detection in washing machines



Non-contact, inline thickness measurement of plastic films



**DZ140**

Sensor for rotational speed measurement during driving operations and tests

Optimized for modern, thin blades made from aluminum or titanium

Speed range from 200 to 400,000 rpm

Wide operating temperature range

Large distance between sensor & blade

No rotor modification required



**SGS Spindle Growth System**

Sensor system developed for measuring the thermal extension of milling spindles

Measuring range 500  $\mu$ m

Resolution 0.5  $\mu$ m

High temperature range



**idiamCONTROL**

Non-contact inspection of extruder bores

Non-contact and wear-free measurement technique for all metals without calibration

Exact, non-destructive inspection



**combiSENSOR**

One-side thickness measurement of plastic films and coated metals (battery film)

Thickness of the target 40  $\mu$ m to max. 6 mm

Working distance 2 to 10 mm

Resolution 0.0018 % FSO

Frequency response 1 kHz (-3dB)



**FSC1/7 / FSC1000**

Measuring device for the detection of coating thickness on CFRP and other substrates

Quick & easy coating thickness measurement

Non-destructive principle - no influence on coating or substrate

No coupling medium required

Configurable, dynamic tilt prevention

Qualified by renowned aircraft manufacturers

# > Measuring & inspection systems

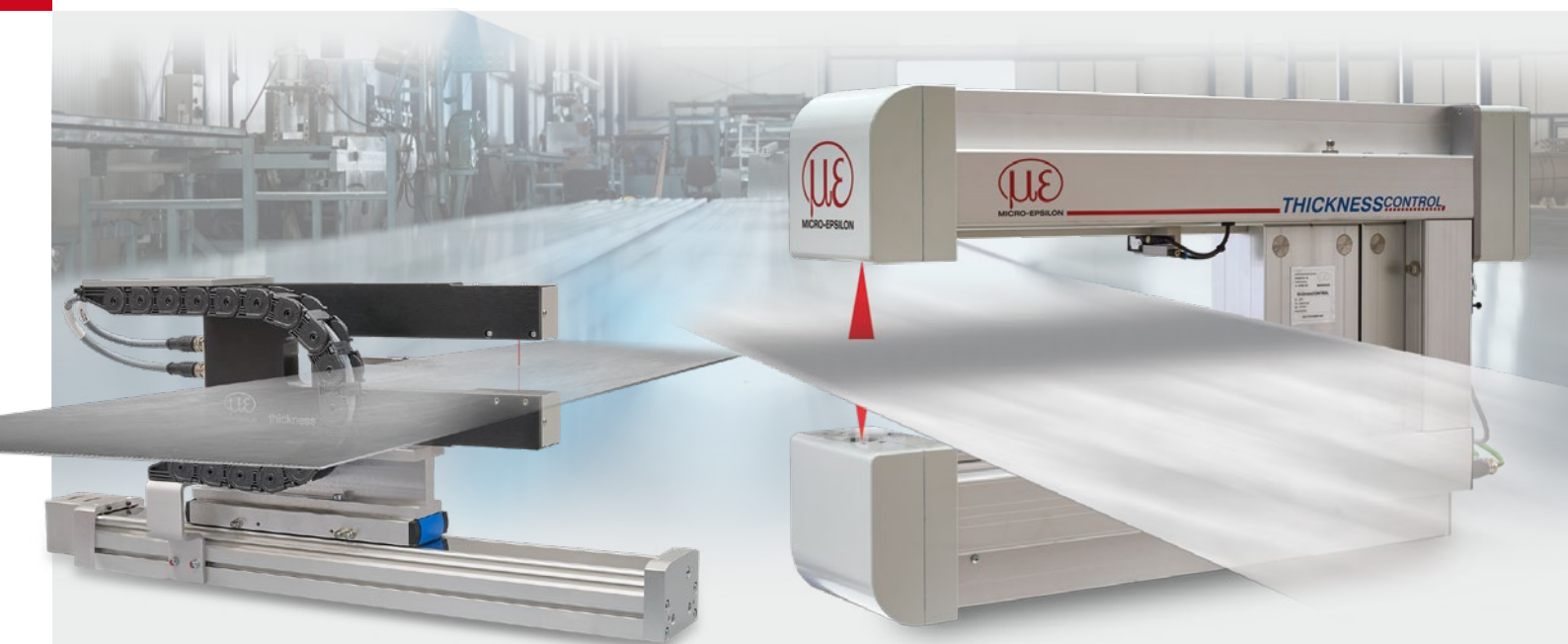

Measuring and testing systems from Micro-Epsilon combine sensors, software and mechanics in an integrated overall solution. The systems are used for process monitoring and quality assurance in the production line and impress with high precision and ease of integration. The sensor and software modules used originate from the Micro-Epsilon group, enabling optimum and efficient component matching.

These measuring and inspection systems are integrated into existing or newly designed production lines to carry out fully automatic applications such as thickness measurements, surface inspections and parts classification. The systems are used, for example, in metal rolling mills, battery production, the plastics industry, and in the manufacture of tires and technical rubber.

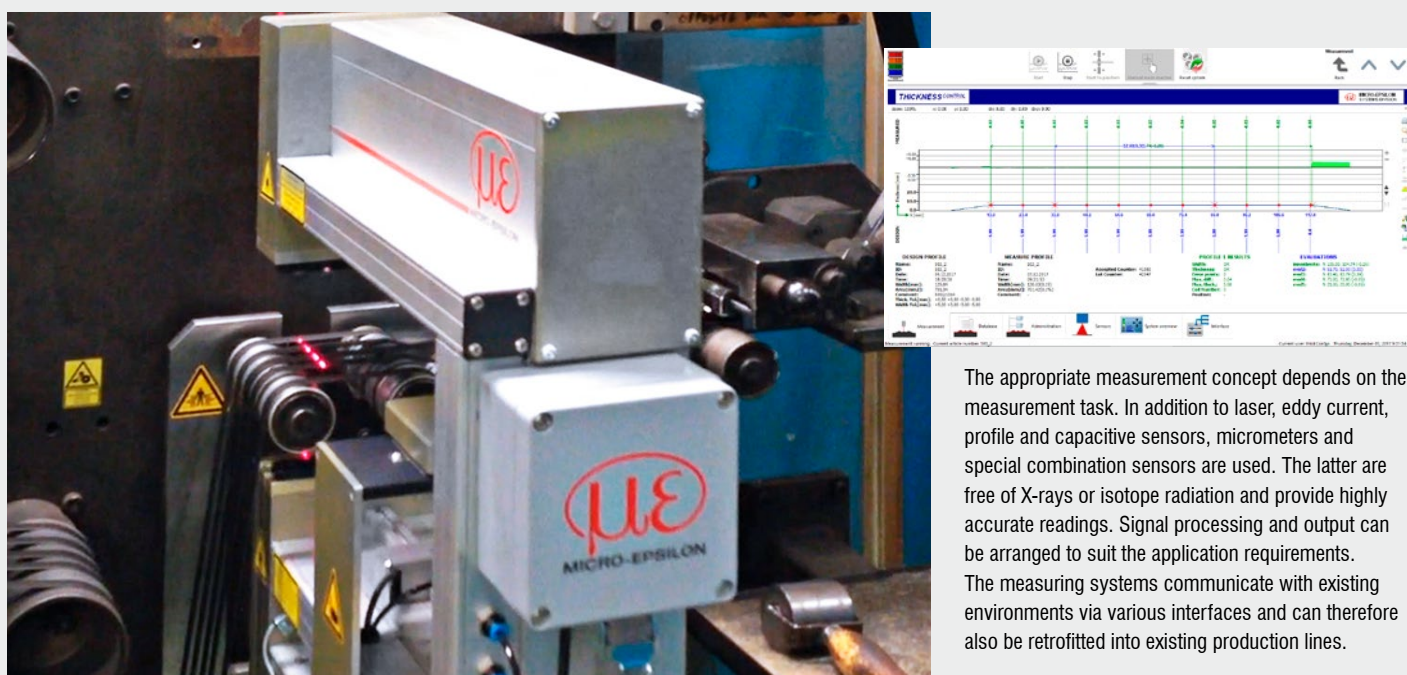

The appropriate measurement concept depends on the measurement task. In addition to laser, eddy current, profile and capacitive sensors, micrometers and special combination sensors are used. The latter are free of X-rays or isotope radiation and provide highly accurate readings. Signal processing and output can be arranged to suit the application requirements. The measuring systems communicate with existing environments via various interfaces and can therefore also be retrofitted into existing production lines.

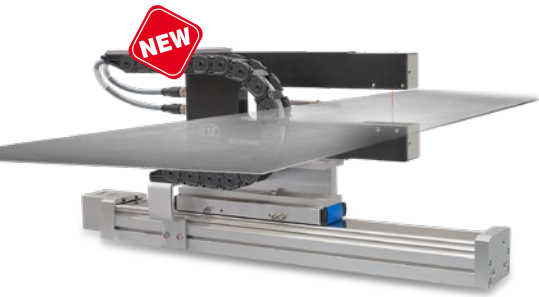

**thicknessGAUGE**

Sensor system for precise inline thickness measurements  
 For many types of surfaces / materials due to different sensor technologies  
 Traversing sensors on linear axis  
 Fully automatic calibration



**thicknessGAUGE.laser**  
 Sensor technology used:  
 Laser triangulation displacement sensors

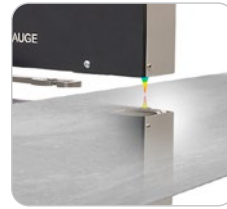

**thicknessGAUGE.confocal**  
 Sensor technology used:  
 Confocal chromatic displacement sensors

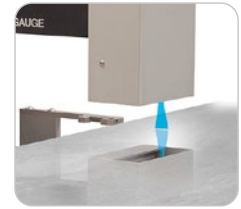

**thicknessGAUGE.laser profile**  
 Sensor technology used:  
 Blue Laser profile sensors



**Systems for the preparation area in the rubber and tire production**

Profilometer  
 Color code  
 Measuring length



**Final finishing systems in the rubber and tire production**

Tire geometry  
 Tire marking  
 Tire identity



**Systems for the plastics inspection**

C-frames for thickness measurement of flat film  
 O-frame systems for profile thickness measurement  
 Reverse-frame systems for the profile measurement of blown films



**C-frame for metal thickness measurement**

For high speed measurements  
 Laser point or innovative laser line  
 All alloys without calibration



**Powerful C-frames for harsh environments**

Various measuring ranges  
 Proven protection and cleaning concepts  
 Several C-frames with only one IPC



**O-frame systems for the metals industry**

Most modern thickness profile measurement  
 Without isotopes and X-rays  
 Measurement independent from strip movement, tilt, surface type and alloys



**MICRO-EPSILON**

MICRO-EPSILON Headquarters

Koenigbacher Str. 15 · 94496 Ortenburg / Germany

Tel. +49 (0) 8542 / 168-0 · Fax +49 (0) 8542 / 168-90

[info@micro-epsilon.com](mailto:info@micro-epsilon.com)

[www.micro-epsilon.com](http://www.micro-epsilon.com)